

EUROFER®

LAVORAZIONE DEL FERRO BATTUTO & ACCIAIO INOX
WROUGHT IRON & STAINLESS STEEL WORKING



1967 55

OFFER

LA PRODUZIONE COMPLETA
THE WHOLE PRODUCTION





**LA PRODUZIONE COMPLETA
DI ELEMENTI IN FERRO BATTUTO**

**THE WHOLE PRODUCTION
OF WROUGHT IRON COMPONENTS**

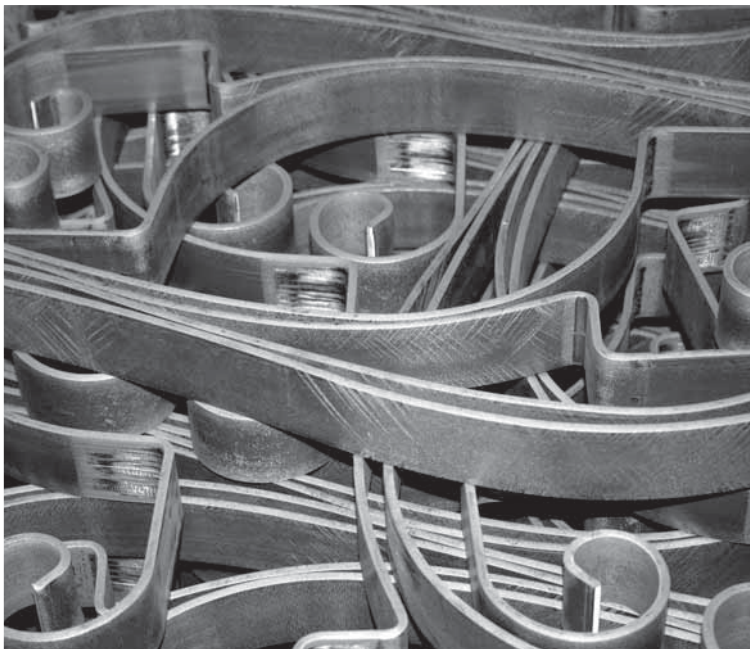
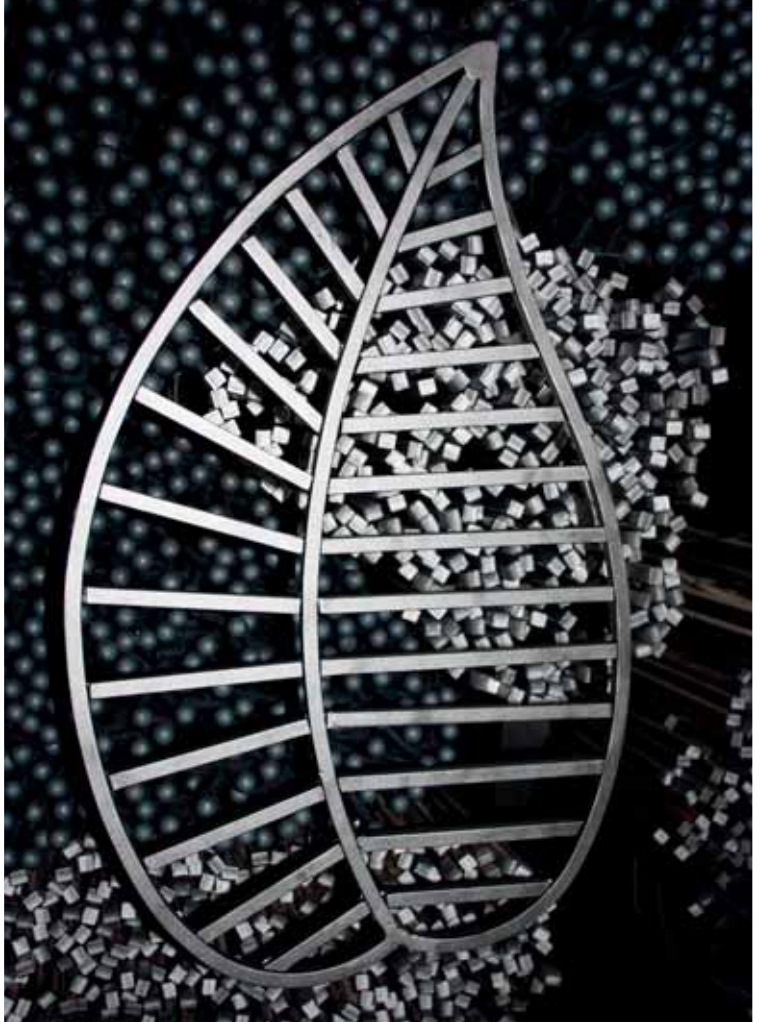
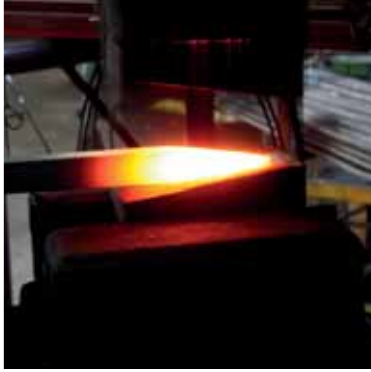
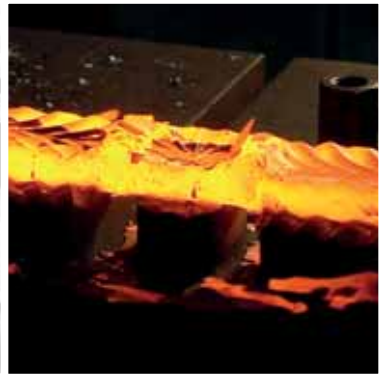
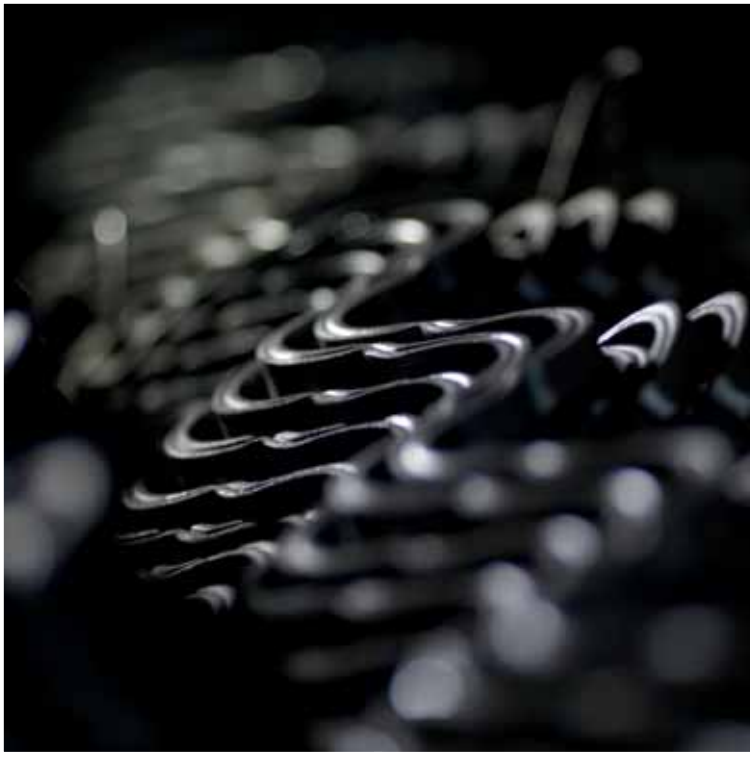
**LA PRODUCTION COMPLETE
D'ELEMENTS EN FER FORGÉ**



INDICE / INDEX / INDEX

	CONDIZIONI DI VENDITA / <i>GENERAL CONDITIONS</i>	PAG	4
	LEGENDA / <i>LEGENDA</i>		5
	TERMINALI / <i>ENDS / FINITIONS</i>		6
01	RICCI <i>SCROLLS / VOLUTES</i>		7
02	CERCHI, OVALI E PIGNE <i>CIRCLES, OVALS AND BASKETS / CERCLES, OVALES ET PIGNES TORSADÉES</i>		34
03	ROSONI E QUADRILOBI <i>ROSETTES AND CLIP-ON-UNITS / ROSACES ET ELEMENTS DÉCORATIFS</i>		42
04	BARRE SAGOMATE - LINEA LIBERTY <i>SHAPED BARS - LIBERTY LINE / BARREAUX GALBÉS - PANNEAUX DÉCO</i>		60
05	PANNELLI LISCI E PALETTI PER RECINZIONI <i>PLAIN PANEL UNITS AND STAKES FOR FENCES BARREAUX DE BALCON ET DE CLÔTURE</i>		75
06	PANNELLI MARTELLATI <i>HAMMERED PANELS / PANNEAUX MARTELÉS</i>		113
07	PANNELLI LIQUIRIZIA - PANNELLI RIGATI <i>LIQUORICE PANELS - FLUTED PANELS PANNEAUX RÉGLISSE ET RAYÉS</i>		118
08	BARRE FORATE <i>HOLED BARS / BARRES À TROUS</i>		122
09	TENDENZE ODIERNE <i>MODERN DESIGNS / BARREAUX DÉCORATIFS</i>		136
10	ELEMENTI IN FERRO RICALCATO <i>NEW FORGED BARS / ÉLÉMENTS MODERNES</i>		156
11	ELEMENTI IN FERRO FORGIATO, CAPISALDI E FORGIATI ITALIANI <i>FORGED BARS, POSTS AND  FORGED BARS PANNEAUX FORGÉS, POTEAUX ET FER FORGÉ </i>		164
12	CORRIMANO E PARTENZE <i>HANDRAILS AND CORNERS / MAIN COURANTES, CROSSES DE DÉPART</i>		182
13	BORCHIE, LANCE E PIASTRE <i>STUDS, SPEARS AND PLATES / FERS DE LANCE, BAGUES, PLATINES ACIER</i>		202
14	FIORI E FOGLIE <i>FLOWERS AND LEAVES / FLEURS ET FEUILLES</i>		220
15	CIMASE, TERMINALI ED ELEMENTI VARI <i>ORNAMENTS FOR CARRIAGE GATES AND VARIOUS ELEMENTS ELEMENTS POUR PORTAILS, CLÉS DE TIRANTS ET DIVERS ÉLÉMENTS</i>		229
16	COMPONENTI VARI PER ARREDAMENTO <i>VARIOUS DECOR ELEMENTS / POIGNÉES ET DIVERS ÉLÉMENTS DE DÉCORATION</i>		244
CI	COMPONENTI IN GHISA <i>ELEMENTS IN CAST IRON / FONTE</i>		256
ZF	ARTICOLI ZINCATI A FREDDO <i>COLD GALVANIZED ARTICLES / ÉLÉMENTS GALVANISÉS</i>		257
	Riassunto barre forate in ordine di codice <i>Summary holed bars in order of code / Barre à trous par ordre de référence</i>		261
L	LASERFER		268

CONDIZIONI GENERALI / GENERAL CONDITIONS

1. Offerte e Ordini

1.1 I tempi di consegna riportati nelle Offerte e nelle Conferme d'Ordine sono puramente indicativi e quindi non vincolanti.

1.2 In nessun caso Euro-Fer Spa potrà essere chiamata a risponderne dei danni direttamente o indirettamente causati dalla ritardata esecuzione di un contratto o dalla ritardata consegna dei prodotti.

1.3 Gli ordini e/o le modifiche di ordini effettuate verbalmente devono essere confermati per iscritto da parte dell'acquirente. In caso contrario Euro-Fer Spa non si assume alcuna responsabilità con riguardo a eventuali errori o possibili fraintendimenti.

1.4 Euro-Fer Spa si riserva la possibilità di frazionare un ordine in più spedizioni.

1.5 I prezzi non sono comprensivi di IVA.

2. Restituzione merci

2.1 Euro-Fer Spa non è obbligata ad accettare resi dei prodotti, salvo che sia stato espressamente pattuito per iscritto. Qualsiasi costo a tal fine è sostenuto dall'Acquirente.

2.2 In tutti i casi Euro-Fer Spa non accetta resi di materiale manomesso o modificato rispetto alla fornitura iniziale.

3. Reclami

3.1 Al momento della presa in consegna dei prodotti l'Acquirente dovrà immediatamente verificare la quantità, l'imballaggio e la conformità, e registrare qualsiasi obiezione nella nota di consegna.

3.2 Ogni denuncia per vizi, dovrà essere effettuata tramite comunicazione scritta entro 8 giorni dall'arrivo della merce.

3.3 La comunicazione di cui al 3.2 dovrà chiaramente identificare la fornitura originale e specificare tipologia e ammontare dei vizi addotti.

4. Varie

4.1 Le misure e le fotografie espresse nel catalogo sono indicative, pertanto i prodotti venduti possono differire leggermente.

4.2 Euro-Fer Spa non accetterà reclami per inconvenienti o anomalie dovuti a applicazioni post-vendita non corrette o non adeguate al prodotto. Trattamenti quali verniciatura, zincatura elettrolitica, zincatura a caldo, sabbiatura, o altri, realizzati dopo la vendita, saranno eseguiti sollevando Euro-fer Spa da qualsiasi responsabilità.

4.3 La riproduzione, anche parziale, del presente catalogo è vietata. Tutti i diritti sono riservati da Euro-Fer Spa.

4.4 I documenti, disegni, dati ed informazioni che dovessero venire consegnati al Cliente, rimangono di esclusiva proprietà di Euro-Fer Spa. Il Cliente si impegna a non riprodurli, a non divulgarli a terzi e ad assumere altresì le opportune cautele nei confronti del proprio personale al fine di garantirne la tutela.

4.5 La gamma di Euro-Fer Spa è composta da articoli di differenti materiali: ferro, acciaio, ottone, ghisa, plastica, cristallo, vetro, etc, ciascuno con le proprie caratteristiche e adatto a particolari utilizzi. E' esclusiva responsabilità del Cliente scegliere i prodotti più indicati alle proprie esigenze ornamentali e di utilizzo.

1. Offers and Orders

1.1 *The delivery terms specified in the Offer and in the Order Confirmation are purely indicative and not binding.*

1.2 *In no case will Euro-Fer Spa be liable for damages directly or indirectly caused by the delayed execution of a contract or the delayed delivery of the products.*

1.3 *Purchase orders and / or changes to purchase orders made verbally must be confirmed in writing by the Buyer. Otherwise, Euro-Fer Spa assumes no responsibility for any errors or misunderstandings.*

1.4 *Euro-Fer Spa reserves the right to split a purchase order in several consignments.*

1.5 *Prices do not include VAT.*

2. Return policy

2.1 *Euro-Fer Spa is not obliged to accept returns of products, unless expressly agreed in writing. Any cost arising from the return shall be borne by the Buyer.*

2.2 *In all cases Euro-Fer Spa does not accept returns of material tampered with or modified with respect to what was initially supplied.*

3. Claims

3.1 *Upon receipt of the products, the Buyer shall immediately check the quantity, packaging and conformity, and record any objections in the delivery note.*

3.2 *Any complaint for defects must be made by written communication within 8 days of receipt of the goods.*

3.3 *The written communication relating to paragraph 3.2 must clearly identify the original supply and specify the type and number of defects alleged.*

4. Others

4.1 *Sizes and pictures shown in the catalogues are indicative, therefore the products may differ slightly.*

4.2 *Euro-Fer Spa will not accept claims for inconveniences or anomalies due to incorrect or inappropriate after-sales applications of its products. Treatments such as painting, electrolytic zinc-plating, hot dip galvanizing, sandblasting, or others, made after the sale, will be carried out by relieving Euro-fer Spa from any responsibility.*

4.3 *The reproduction, even partial, of this catalogue is strictly forbidden. All rights are reserved by Euro-Fer Spa.*

4.4 *The documents, drawings, data and information provided from Euro-fer Spa to the Buyer, remain exclusive property of Euro-Fer Spa. The Buyer undertakes not to reproduce them, not to disclose them to third parties and at the same time to take the appropriate precautions toward their staff in order to guarantee its protection.*

4.5 *Euro-Fer Spa range consists of items made of different materials: iron, steel, brass, cast iron, plastic, crystal, glass, etc., each with its own characteristics and suitable for specific uses. It is sole responsibility of the Buyer to choose the most suitable products for its ornamental and use needs.*

LEGENDA / LEGENDA

Le misure sono espresse in millimetri. La lettera "H" sta per altezza e "L" per larghezza, mentre le sezioni sono indicate con i simboli: $\neq \emptyset$ □ (piatto, tondo o diametro, quadro). Tra le dimensioni indicate e quelle reali vi possono essere delle lievi differenze, proprio perchè ogni elemento è prodotto in gran parte a mano.

(ca.) - Per le caratteristiche particolari del ferro forgiato, le misure degli articoli che seguono possono subire delle lievi variazioni dovute al tipo di lavorazioni cui sono sottoposti.

EURO-FER si riserva di apportare qualsiasi variazione ai dati indicati, al fine di migliorare il prodotto.

A richiesta è possibile realizzare produzioni personalizzate con motivi e misure non presenti in questo catalogo. Le personalizzazioni sono possibili solo per determinate quantità.

All dimensions are expressed in millimeters. The letter "H" stands for height; "L" stands for length, while the shapes of the sections are indicated with the symbols: $\neq \emptyset$ □ (flat, round or diameter, square). There may be slight differences between the dimensions indicated and the real dimensions, precisely because each creation is produced in large part by the craftsman's hand.

(ca.) - Because of their peculiarity, the measures of forged bars could be subjected to small variations due to their particular working process.

EURO-FER retains the right to change the specification indicated in order to improve the product.

Personalized creations with patterns and sizes not illustrated in this catalogues can be ordered on request. Personalized work can be performed only for certain quantities.

.AL Articolo realizzato in alluminio
Item made of Aluminum

.B Borchia svasata
Iron bush with countersunk hole

.CI Articolo in ghisa
Item made of Cast Iron

.CS Articolo in Fusione
Item made of Cast Steel

.CO Superficie tipo 'Corteccia'
"Bark" type surface

.D Misura intermedia tra l'articolo standard e la versione .E
Intermediate size between the standard item and the .E version (lightened or smaller)

.E modello come l'articolo di riferimenti ma 'alleggerito' e quindi più economico
Item similar to article of reference (same item number) but 'lightened' or smaller and therefore cheaper

.ES modello España
Identifies the 'España' models, popular in particular markets

.R Borchia Rullata
Iron bush with rolled surface

.RM Rigato e Martellato
Fluted and hammered profile

.S Smussato
Edged corners profile

.ZC *Zincato a Caldo
**Hot-dip galvanized item*

.ZF *Zincato a Freddo
**Cold galvanized item*

Liquirizia Modello Rigato, Martellato e Attorcigliato
Liquorice *Fluted, hammered and twisted profile*

Linea Liberty, articoli che possono includere particolari in ghisa o in ferro fuso.
The Liberty Line identifies items that can include parts made of cast iron or cast steel.



Modello depositato
Patent pending



Fiori da entrambi i lati
Flowers on both sides

* Ricordiamo che il trattamento di zincatura (a caldo o a freddo) serve a proteggere gli articoli in ferro dalla corrosione, non è un trattamento di finitura estetica.

Euro-Fer Spa non accetta reclami dovuti all'aspetto della zincatura (opaca o lucida, chiara o scura, presenza di cenere o gocce dal bagno di zinco, etc.).

**We remind you that the galvanizing treatment (hot or cold) is used to protect iron products from corrosion, it is not an aesthetic finishing treatment.*

Euro-Fer Spa doesn't accept complaints regarding the shape of the galvanizing (shiny or matt, light or dark, ashes or drops from the zinc bath, etc.).

Nuovo articolo
New item

NEW

TERMINALI / ENDS / FINITIONS

———— a freddo / cold cut / à froid ————

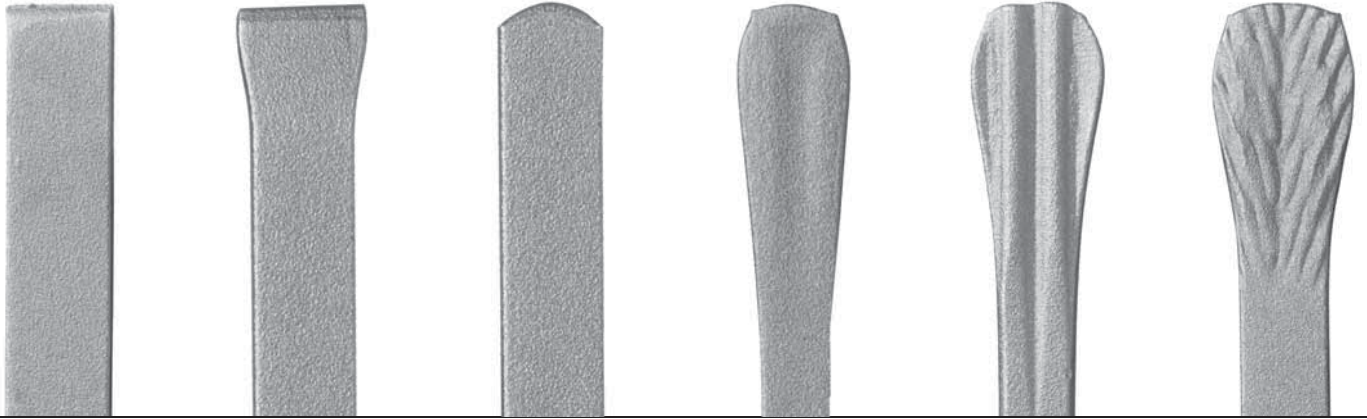

tranciato dritto
straight cut
coupe droite

TD

tranciato punta
pointed cut
coupe pointu

TP

tranciato arrotondato
rounded cut
coupe ronde

PA

rastremato liscio
smooth tapered
effilé lisse

RL

rastremato rigato
tapered and fluted
effilé rayé

RR

a "spina di pesce"
"fish bone"
à chevrons

SP

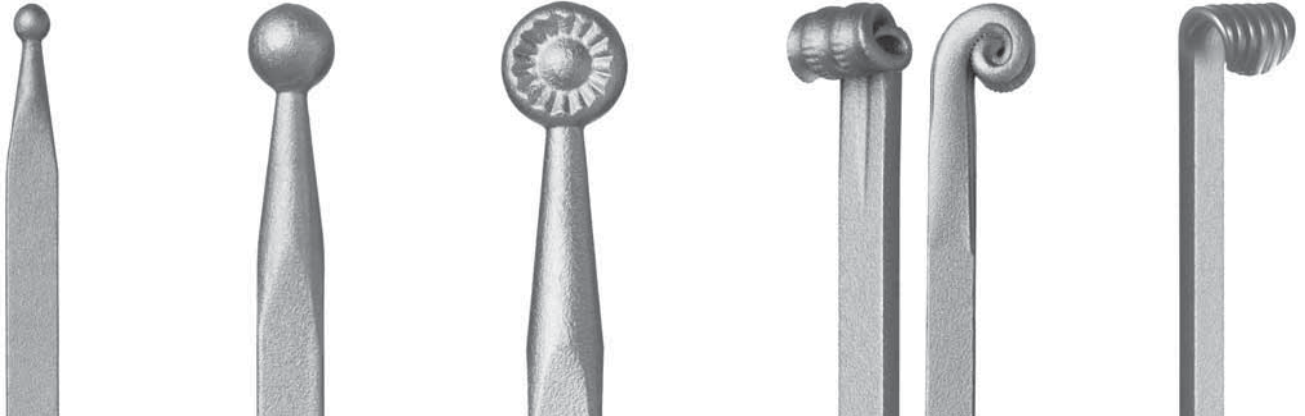

pallina piccola
small ball
petite boule

PP

pallina grande
large ball
grosse boule

PG

pallina "a sole"
sun ball
boule "soleil"

PS

chiocciola rigata
fluted spiral
escargot rayé

CR

uncino rigato
fluted hook
crochet rayé

UR

———— a freddo / cold cut / à froid ————



chiocciola schiacciata
pressed spiral
escargot écrasé

CS

nocciolina a caldo
peanut (heat forging)
cacahuète à chaud

NC

schiacciata a freddo liscia
cold-pressed
écrasée à froid

SF

schiacciata a freddo rigata
cold fluted pressed
écrasée et rayée à froid

SR

TP



H.117 X L.60 mm.

- Art. 01.001 □ 8 X 8
- Art. 01.002 ≙ 16 X 4
- Art. 01.003 ≙ 10 X 5
- Art. 01.004 ≙ 12 X 6
- Art. 01.005 ≙ 20 X 6
- Art. 01.005.01 ≙ 14 X 6
- Art. 01.005.02 ≙ 20 X 4

RL



TP



H.125 X L.75 mm.

- Art. 01.005.11 ≙ 20 X 6
- Art. 01.005.12 ≙ 14 X 6
- Art. 01.005.14 ≙ 16 X 6

TP



H.135 X L.75 mm.

- Art. 01.006 □ 8 X 8
- Art. 01.007 ≙ 16 X 4
- Art. 01.008 ≙ 10 X 5
- Art. 01.009 ≙ 12 X 6
- Art. 01.010 ≙ 20 X 6
- Art. 01.010.01 ≙ 14 X 6
- Art. 01.010.02 ≙ 20 X 4

TP



H.180 X L.105 mm.

- Art. 01.010.12 ≙ 14 X 6
- Art. 01.010.14 ≙ 16 X 6

TP



H.180 X L.85 mm.

- Art. 01.011 □ 8 X 8
- Art. 01.012 ≙ 16 X 4
- Art. 01.013 ≙ 10 X 5
- Art. 01.014 ≙ 12 X 6
- Art. 01.015 ≙ 20 X 6
- Art. 01.015.01 ≙ 14 X 6
- Art. 01.015.02 ≙ 20 X 4

TP



H.220 X L.100 mm.

- Art. 01.015.10 ≙ 12 X 6

H.225 X L.100 mm.

- Art. 01.015.20 ≙ 16 X 4

TP



H.220 X L.90 mm.

- Art. 01.016 □ 8 X 8
- Art. 01.017 ≙ 16 X 4
- Art. 01.018 ≙ 12 X 6
- Art. 01.018.01 ≙ 14 X 6

TP



H.210 X L.100 mm.

- Art. 01.018.08 ≙ 16 X 4
- Art. 01.018.10 ≙ 12 X 6

TP



H.220 X L.110 mm.

- Art. 01.019 □ 8 X 8
- Art. 01.020 ≙ 16 X 4
- Art. 01.021 ≙ 10 X 5
- Art. 01.022 ≙ 12 X 6
- Art. 01.023 ≙ 14 X 6
- Art. 01.024 ≙ 20 X 6
- Art. 01.024.01 ≙ 20 X 4

TP



H.290 X L.120 mm.

- Art. 01.025 □ 8 X 8
- Art. 01.026 ≙ 16 X 4
- Art. 01.027 ≙ 10 X 5
- Art. 01.028 ≙ 12 X 6
- Art. 01.029 ≙ 14 X 6
- Art. 01.030 ≙ 20 X 6
- Art. 01.030.01 ≙ 20 X 4

TP



H.325 X L.115 mm.

- Art. 01.030.10 ≙ 16 X 6

TP



H.360 X L.125 mm.

- Art. 01.031 □ 8 X 8
- Art. 01.032 ≙ 16 X 4
- Art. 01.033 ≙ 10 X 5
- Art. 01.034 ≙ 12 X 6
- Art. 01.035 ≙ 14 X 6
- Art. 01.036 ≙ 20 X 6
- Art. 01.036.01 ≙ 20 X 4

TP

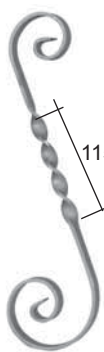

H.350 X L.100 mm.

- Art. 01.037 □ 8 X 8
- Art. 01.038 ≙ 16 X 4
- Art. 01.039 ≙ 10 X 5
- Art. 01.040 ≙ 12 X 6
- Art. 01.040.01 ≙ 14 X 6

TP



H.290 X L.100 mm.

- Art. 01.040.08 ≙ 16 X 4
- Art. 01.040.10 ≙ 12 X 6

TP



H.290 X L.120 mm.

- Art. 01.041 ≙ 16 X 4
- Art. 01.042 ≙ 12 X 6
- Art. 01.043 ≙ 14 X 6
- Art. 01.044 ≙ 20 X 6
- Art. 01.044.01 ≙ 20 X 4

TP



H.360 X L.125 mm.

- Art. 01.045 ≙ 16 X 4
- Art. 01.046 ≙ 12 X 6
- Art. 01.047 ≙ 14 X 6
- Art. 01.048 ≙ 20 X 6
- Art. 01.048.01 ≙ 20 X 4

TP



H.290 X L.125 mm.

- Art. 01.049 ≙ 16 X 4

TP



H.450 X L.95 mm.

- Art. 01.050 ≙ 16 X 4

TP



H.450 X L.125 mm.

- Art. 01.051 ≙ 16 X 4
- Art. 01.052 ≙ 20 X 6

TP



H.150 X L.105 mm.

- Art. 01.052.06 ≙ 14 X 6
- Art. 01.052.10 ≙ 16 X 6

TP

tranciato punta a freddo
cold pointed cut



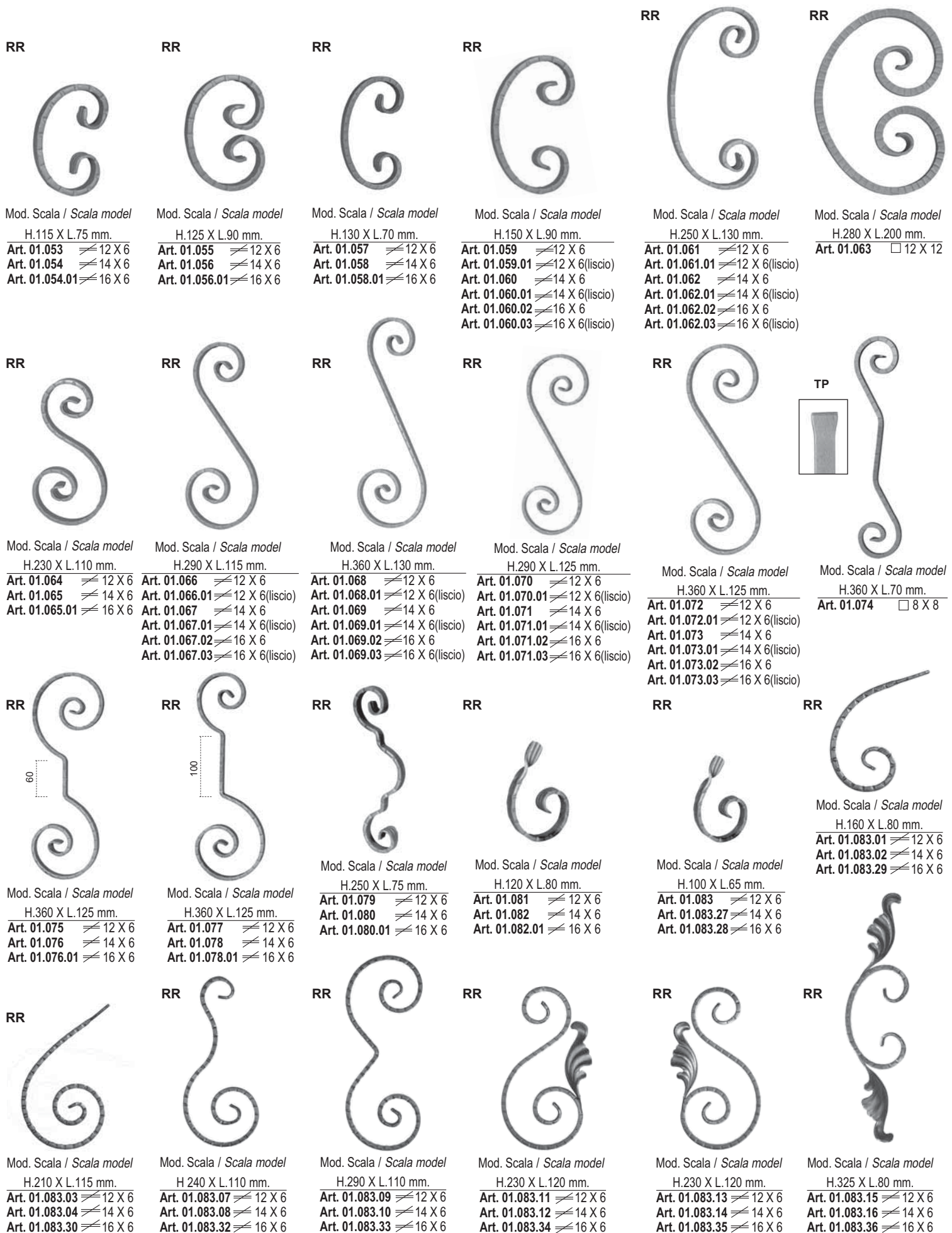

Tutte le parti di questo catalogo - foto comprese - sono di proprietà Euro-Fer. La riproduzione, anche parziale, è vietata in ogni forma e con ogni mezzo. / Every part of this catalogue - photos included - is Euro-Fer's property. All forms of copying are strictly prohibited.



RR
Mod. Scala / Scala model
H.145 X L.75 mm.
Art. 01.083.17 ≙ 12 X 6
Art. 01.083.18 ≙ 14 X 6
Art. 01.083.37 ≙ 16 X 6



RR
Mod. Scala / Scala model
H.110 X L.60 mm.
Art. 01.083.19 ≙ 12 X 6
Art. 01.083.20 ≙ 14 X 6
Art. 01.083.38 ≙ 16 X 6



RR
Mod. Scala / Scala model
H.200 X L.100 mm.
Art. 01.083.21 ≙ 14 X 6
Art. 01.083.39 ≙ 16 X 6



RR
Mod. Scala / Scala model
H.220 X L.110 mm.
Art. 01.083.22 ≙ 14 X 6
Art. 01.083.41 ≙ 16 X 6



RR
Mod. Scala / Scala model
H.380 X L.180 mm.
Art. 01.083.23 ≙ 12 X 6
Art. 01.083.24 ≙ 14 X 6
Art. 01.083.43 ≙ 16 X 6



RR
Mod. Scala / Scala model
H.310 X L.35 mm.
Art. 01.083.25 ≙ 14 X 6
Art. 01.083.44 ≙ 16 X 6



RR
Mod. Scala / Scala model
H.420 X L.35 mm.
Art. 01.083.26 ≙ 14 X 6



RR
Liscio / Smooth
H.220 X L.110 mm.
Art. 01.086.01 ≙ 12 X 6
Art. 01.086.11 ≙ 16 X 8

Mod. Scala / Scala model
H.220 X L.110 mm.
Art. 01.086.02 ≙ 12 X 6

Martellato / Hammered
H.220 x L.110 mm
Art. 01.086.51 ≙ 12 x 6



RR
Liscio / Smooth
H.200 X L.100 mm.
Art. 01.086.03 ≙ 12 X 6
Art. 01.086.13 ≙ 16 X 8

Mod. Scala / Scala model
H.200 X L.100 mm.
Art. 01.086.04 ≙ 12 X 6
Art. 01.086.14 ≙ 16 X 8

Martellato / Hammered
H.200 x L.100 mm
Art. 01.086.50 ≙ 12 x 6

RR
rastremato rigato a caldo
hot tapered and fluted

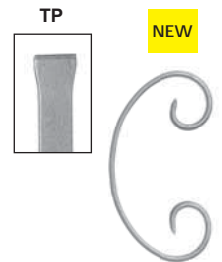

TP
NEW
H.140 X L.75 mm.
Art. 01.086.70 ≙ 12 X 4
Art. 01.086.71 ≙ 14 X 4
Art. 01.086.72 ≙ 16 X 4



SF
H.115 X L.80 mm.
Art. 01.084 □ 8 X 8



SF
H.115 X L.80 mm.
Art. 01.084.01 Ø 8



SR
Mod. Scala / Scala model
H.120 X L.75 mm.
Art. 01.085 □ 8 X 8



RL
Mod. Scala / Scala model
H.120 X L.75 mm.
Art. 01.086 □ 8 X 8



RR
Martellato / Hammered
H.115 x L.75 mm
Art. 01.086.20 ≙ 12 x 6

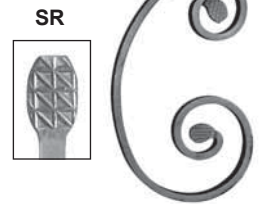

SR
H.180 X L.110 mm.
Art. 01.087 ≙ 12 X 6

Tutte le parti di questo catalogo - foto comprese - sono di proprietà Euro-Fer. La riproduzione, anche parziale, è vietata in ogni forma e con ogni mezzo. / Every part of this catalogue - photos included - is Euro-Fer's property. All forms of copying are strictly prohibited.

SP
ricci e terminali
"a spina di pesce"
"fish bone"
scrolls and end



SP



H.100 X L.60 mm.
Art. 01.086.05 ≙ 12 X 6
Art. 01.086.06 ≙ 14 X 6
Art. 01.086.15 ≙ 16 X 6
Art. 01.086.18 ≙ 20 X 6

SP



H.125 X L.75 mm.
Art. 01.086.07 ≙ 12 X 6
Art. 01.086.08 ≙ 14 X 6
Art. 01.086.16 ≙ 16 X 6
Art. 01.086.19 ≙ 20 X 6

SP



H.150 X L.80 mm.
Art. 01.086.09 ≙ 12 X 6
Art. 01.086.10 ≙ 14 X 6
Art. 01.086.17 ≙ 16 X 6
Art. 01.086.21 ≙ 20 X 6

SP



H.180 X L.105 mm.
Art. 01.086.24 ≙ 14 X 6
Art. 01.086.25 ≙ 16 X 6
Art. 01.086.26 ≙ 20 X 6

SP



H.200 X L.125 mm.
Art. 01.086.30 ≙ 14 X 6
Art. 01.086.31 ≙ 16 X 6

SP



H.100 X L.65 mm.
Art. 01.086.35 ≙ 14 X 6
Art. 01.086.36 ≙ 16 X 6
Art. 01.086.37 ≙ 20 X 6

SP



H.110 X L.90 mm.
Art. 01.086.40 ≙ 14 X 6
Art. 01.086.41 ≙ 16 X 6
Art. 01.086.42 ≙ 20 X 6

SP



H.150 X L.105 mm.
Art. 01.086.45 ≙ 14 X 6
Art. 01.086.46 ≙ 16 X 6
Art. 01.086.47 ≙ 20 X 6

SP



H.180 X L.125 mm.
Art. 01.086.60 ≙ 14 X 6
Art. 01.086.61 ≙ 16 X 6
Art. 01.086.52 ≙ 20 X 6

SP



H.110 X L.65 mm.
Art. 01.086.62 ≙ 12 X 6
Art. 01.086.63 ≙ 14 X 6
Art. 01.086.64 ≙ 16 X 6

NEW

SP

NEW



H.350 X L.110 mm.
Art. 01.086.80 ≙ 12 X 6
Art. 01.086.81 ≙ 14 X 6
Art. 01.086.82 ≙ 16 X 6

SP

NEW



H.270 X L.110 mm.
Art. 01.086.83 ≙ 12 X 6
Art. 01.086.84 ≙ 14 X 6
Art. 01.086.85 ≙ 16 X 6

SF



H.180 X L.95 mm.
Art. 01.087.01 □ 10 X 10
Art. 01.087.02 ∅ 8

SF



H.180 X L.95 mm.
Art. 01.088 □ 8 X 8

RR



Mod. Scala / Scala model
H.240 X L.50 mm.
Art. 01.088.01 ≙ 12 X 6
Art. 01.088.02 ≙ 14 X 6

SF



H.250 X L.100 mm.
Art. 01.088.03 □ 8 X 8
Art. 01.088.04 □ 10 X 10
Art. 01.088.05 ∅ 8

SF



H.140 X L.60 mm.
Art. 01.088.06 ∅ 8

SF



H.220 X L.110 mm.
Art. 01.089 □ 8 X 8

SF



H.220 X L.110 mm.
Art. 01.089.01 □ 10 X 10
Art. 01.089.02 ∅ 8

SF



H.170 X L.77 mm.
Art. 01.089.03 ∅ 8

SF













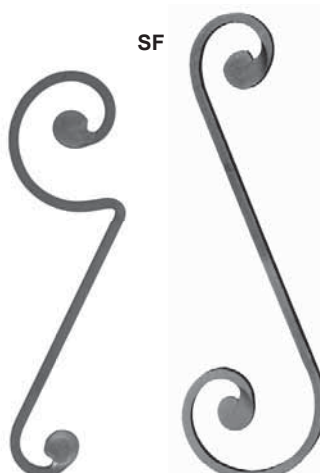

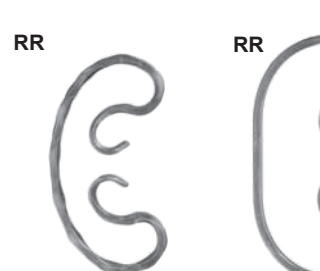



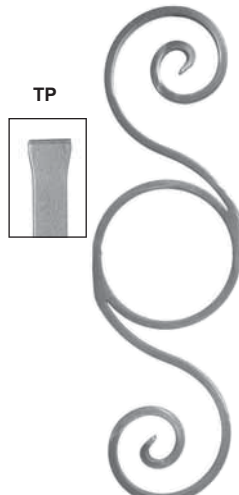



H.290 X L.110 mm.
Art. 01.090 □ 8 X 8

SF

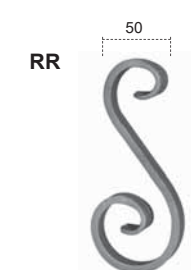

H.290 X L.110 mm.
Art. 01.090.01 □ 10 X 10
Art. 01.090.02 ∅ 8

Attenzione cambio codice / Notice new code

<p>SF SF</p>  <p>H.340 x L.90 mm Art. 01.090.05 □ 8 X 8 Art. 01.090.06 □ 10 X 10</p> <p>H.360 X L.110 mm. Art. 01.091 □ 8 X 8 Art. 01.091.01 □ 10 X 10 Art. 01.091.02 ∅ 8</p>		<p>RR RR</p>  <p>H.100 X L.75 mm. Art. 01.091.03 ≧ 12 X 6 Art. 01.091.04 ≧ 14 X 6 Art. 01.091.19 ≧ 16 X 6</p> <p>H.125 X L.70 mm. Art. 01.091.05 ≧ 16 X 6</p>		<p>RR RR</p>  <p>Martellato / Hammered H.145 X L.75 mm. Art. 01.091.06 ≧ 12 X 6</p> <p>H.175 X L.105 mm. Art. 01.091.07 ≧ 12 X 6 Art. 01.091.08 ≧ 14 X 6</p>		<p>RR</p>  <p>H.280 X L.110 mm. Art. 01.091.09 ≧ 12 X 6 Art. 01.091.10 ≧ 14 X 6</p>					
<p>RR</p>  <p>H.190 X L.75 mm. Art. 01.091.11 ≧ 12 X 6 Art. 01.091.12 ≧ 16 X 6 Art. 01.091.13 ≧ 20 X 6</p>		<p>RR</p>  <p>H.230 X L.110 mm. Art. 01.091.14 □ 10 X 10</p>		<p>RR</p>  <p>H.360 X L.110 mm. Art. 01.091.15 ≧ 12 X 6</p>		<p>TP</p>  <p>H.430 X L.128 mm. Art. 01.091.16 ≧ 16 X 8</p>		<p>RR</p>  <p>H.200 X L.100 mm. Art. 01.091.17 ≧ 14 X 6 Art. 01.091.21 ≧ 16 X 6</p>		<p>RR</p>  <p>H.220 X L.110 mm. Art. 01.091.18 ≧ 14 X 6</p>	
<p>RR</p>  <p>H.95 X L.60 mm. Art. 01.092 ≧ 12 X 6 Art. 01.092.01 ≧ 14 X 6 Art. 01.092.02 ≧ 16 X 6</p>		<p>RR</p>  <p>H.105 X L.70 mm. Art. 01.093 ≧ 12 X 6 Art. 01.093.01 ≧ 14 X 6 Art. 01.093.02 ≧ 16 X 6</p>		<p>RR</p>  <p>H.115 X L.75 mm. Art. 01.094 ≧ 12 X 6 Art. 01.094.01 ≧ 14 X 6 Art. 01.094.04 ≧ 16 X 6</p>		<p>RR</p>  <p>H.120 X L.70 mm. Art. 01.095 ≧ 12 X 6 Art. 01.095.01 ≧ 14 X 6 Art. 01.095.02 ≧ 16 X 6</p>		<p>RR</p>  <p>H.125 X L.70 mm. Art. 01.095.10 ≧ 12 X 6</p>		<p>RR</p>  <p>H.130 X L.70 mm. Art. 01.096 ≧ 12 X 6 Art. 01.096.01 ≧ 14 X 6 Art. 01.096.02 ≧ 16 X 6</p>	
<p>RR</p>  <p>H.150 X L.75 mm. Art. 01.097 ≧ 12 X 6 Art. 01.097.01 ≧ 14 X 6 Art. 01.097.02 ≧ 16 X 6</p>		<p>RR</p>  <p>H.140 X L.95 mm. Art. 01.098 ≧ 12 X 6 Art. 01.098.01 ≧ 14 X 6 Art. 01.098.04 ≧ 16 X 6</p>		<p>RR</p>  <p>H.135 X L.75 mm. Art. 01.098.03 ≧ 12 X 6 Art. 01.098.05 ≧ 16 X 6</p>		<p>RR</p>  <p>H.120 X L.60 mm. Art. 01.099 ≧ 12 X 6 Art. 01.099.01 ≧ 14 X 6 Art. 01.099.02 ≧ 16 X 6</p>		<p>RR</p>  <p>H.150 X L.70 mm. Art. 01.100 ≧ 12 X 6 Art. 01.100.01 ≧ 14 X 6 Art. 01.100.02 ≧ 16 X 6 Art. 01.100.03 ≧ 20 X 6</p>		<p>RR</p>  <p>H.230 X L.115 mm. Art. 01.101 ≧ 12 X 6 Art. 01.101.01 ≧ 14 X 6 Art. 01.101.03 ≧ 16 X 6</p>	

Tutte le parti di questo catalogo - foto comprese - sono di proprietà Euro-Fer. La riproduzione, anche parziale, è vietata in ogni forma e con ogni mezzo. / Every part of this catalogue - photos included - is Euro-Fer's property. All forms of copying are strictly prohibited.

RR



H.220 X L.110 mm.
Art. 01.101.01 ≙ 12 X 6
≙ 20 X 6

RR



H.260 X L.115 mm.
Art. 01.102 ≙ 12 X 6
Art. 01.102.01 ≙ 14 X 6
Art. 01.102.02 ≙ 16 X 6

RR



H.115 X L.95 mm.
Art. 01.103 ≙ 12 X 6
Art. 01.103.01 ≙ 14 X 6
Art. 01.103.02 ≙ 16 X 6

RR



H.230 X L.80 mm.
Art. 01.104 ≙ 12 X 6
Art. 01.104.01 ≙ 14 X 6
Art. 01.104.02 ≙ 16 X 6

RR



H.250 X L.75 mm.
Art. 01.105 ≙ 12 X 6
Art. 01.105.01 ≙ 14 X 6
Art. 01.105.03 ≙ 16 X 6

RR



H.250 X L.100 mm.
Art. 01.105.02 □ 10 X 10

RR



H.360 X L.125 mm.
Art. 01.106 ≙ 12 X 6
Art. 01.106.01 ≙ 14 X 6
Art. 01.106.02 ≙ 16 X 6

RR



H.360 X L.130 mm.
Art. 01.107 □ 12 X 12
Art. 01.107.02 □ 14 X 14

SF



H.400 X L.145 mm.
Art. 01.107.01 □ 12 X 12



RR



H.100 X L.65 mm.
Art. 01.108 ≙ 12 X 6
Art. 01.108.01 ≙ 14 X 6
Art. 01.108.02 ≙ 16 X 6

RR



H.120 X L.80 mm.
Art. 01.109 ≙ 12 X 6
Art. 01.109.01 ≙ 14 X 6
Art. 01.109.02 ≙ 16 X 6

RR



H.135 X L.150 mm.
Art. 01.110 ≙ 14 X 6
Art. 01.111 ≙ 16 X 6

RR



Rigato / Fluted
H.160 X L.100 mm.
Art. 01.112
≙ 16 X 8

RR

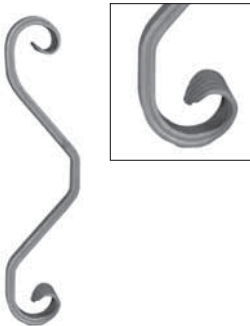

Rigato / Fluted
H.300 X L.70 mm.
Art. 01.113
≙ 16 X 8

RR



H.460 X L.90 mm.
Art. 01.113.01 ≙ 12 X 6

RR



Modello Scala / Scala Model
H.460 X L.90 mm.
Art. 01.113.02 ≙ 12 X 6

RR



Rigato / Fluted
H.360 X L.110 mm.
Art. 01.114 ≙ 12 X 6

TA



H.240 X L.55 mm.
Art. 01.114.01 ≙ 12 X 3

TA



H.250 X L.55 mm.
Art. 01.114.02 ≙ 12 X 3

TD



H.270 X L.90 mm.
Art. 01.114.03 ≙ 12 X 5

TA



H.280 X L.45 mm.
Art. 01.114.04 ≙ 12 X 3

RR



Rigato / Fluted
H.180 X L.120 mm.
Art. 01.114.05 ≙ 16 X 8

RR



Rigato / Fluted
H.180 X L.120 mm.
Art. 01.114.06 ≙ 16 X 8

RR



Rigato / Fluted
H.210 X L.150 mm.
Art. 01.114.07 ≙ 16 X 8

RR



Rigato / Fluted
H.210 X L.150 mm.
Art. 01.114.08 ≙ 16 X 8

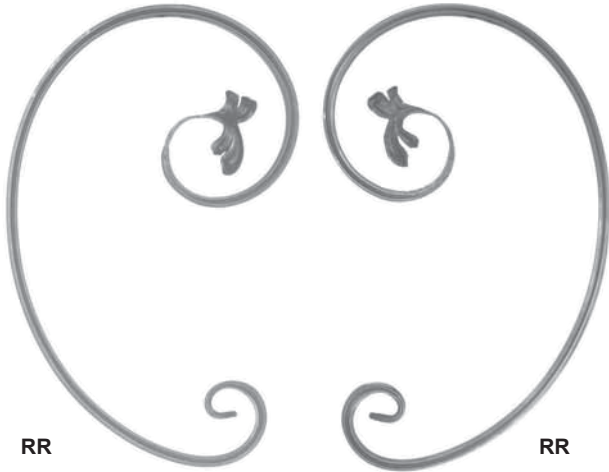

RR

RR

Rigato / Fluted
H.360 X L.230 mm.
Art. 01.114.09 ≙ 16 X 8

Rigato / Fluted
H.360 X L.230 mm.
Art. 01.114.10 ≙ 16 X 8



Rigato / Fluted
H.480 X L.340 mm.
Art. 01.114.11 ≙ 16 X 8

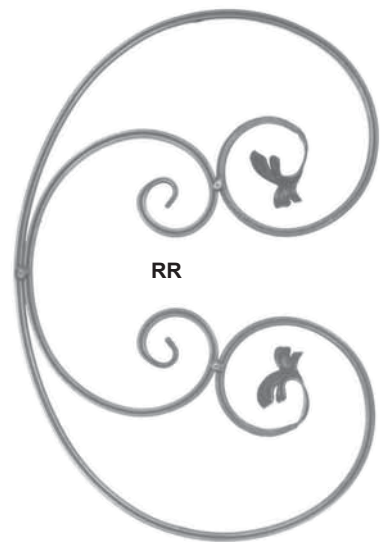

RR

Rigato / Fluted
H.480 X L.320 mm.
Art. 01.114.12 ≙ 16 X 8



Rigato / Fluted
H.410 X L.150 mm.
Art. 01.114.13 ≙ 16 X 8



Rigato / Fluted
H.410 X L.150 mm.
Art. 01.114.14 ≙ 16 X 8



RR

Rigato / Fluted
H.510 X L.270 mm.
Art. 01.114.15 ≙ 16 X 8



RR

Rigato / Fluted
H.510 X L.270 mm.
Art. 01.114.16 ≙ 16 X 8



Rigato / Fluted
H.610 X L.250 mm.
Art. 01.114.17 ≙ 16 X 8

Rigato / Fluted
H.610 X L.250 mm.
Art. 01.114.18 ≙ 16 X 8



RR

Rigato / Fluted
H.240 X L.80 mm.
Art. 01.114.19 ≙ 16 X 8



RR

Rigato / Fluted
H.240 X L.80 mm.
Art. 01.114.20 ≙ 16 X 8



Tutte le parti di questo catalogo - foto comprese - sono di proprietà Euro-Fer. La riproduzione, anche parziale, è vietata in ogni forma e con ogni mezzo. / Every part of this catalogue - photos included - is Euro-Fer's property. All forms of copying are strictly prohibited.

RR



Rigato / Fluted
H.190 X L.110 mm.
Art. 01.114.21 ≙ 16 X 8

RR



Rigato / Fluted
H.270 X L.190 mm.
Art. 01.114.22 ≙ 16 X 8

RR



Rigato / Fluted
H.350 X L.220 mm.
Art. 01.114.23 ≙ 16 X 8

RR



Rigato / Fluted
H.210 X L.150 mm.
Art. 01.114.24 ≙ 16 X 8

RR



Rigato / Fluted
H.360 X L.230 mm.
Art. 01.114.26 ≙ 16 X 8



H.400 X L.150 mm.
Art. 01.115 ≙ 12 X 6



H.400 X L.150 mm.
Art. 01.116 ≙ 12 X 6



H.205 X L.150 mm.
Art. 01.117 ≙ 12 X 6
Art. 01.117.01 ≙ 14 X 6
Art. 01.117.02 ≙ 16 X 6



H.250 X L.150 mm.
Art. 01.118 ≙ 12 X 6
Art. 01.118.03 ≙ 14 X 6
Art. 01.118.04 ≙ 16 X 6
Art. 01.118.05
≙ 12 X 6 Mod. Scala / Scala Model
Art. 01.118.06
≙ 16 X 5 Martellato / Hammered



H.250 X L.150 mm.
Art. 01.118.01 Ø 10



Liscio / Smooth
H.500 x L.310 mm
Art. 01.118.10 ≙ 12 x 6

RR



H.200 X L.125 mm.
Art. 01.119 ≙ 12 X 6

RR



H.200 X L.125 mm.
Art. 01.120 ≙ 12 X 6

RR



H.115 X L.100 mm.
Art. 01.120.01 ≙ 12 X 6

RR



H.115 X L.100 mm.
Art. 01.120.02 ≙ 12 X 6

RR



H.80 X L.325 mm.
Art. 01.121 ≙ 12 X 6
Art. 01.121.01 ≙ 14 X 6



CR

Martellato / Hammered
H.175 X L.115 mm.
Art. 01.122 ≙ 16 X 8



CR

Martellato / Hammered
H.125 X L.80 mm.
Art. 01.123 ≙ 16 X 8



CR

Martellato / Hammered
H.115 X L.65 mm.
Art. 01.124 ≙ 16 X 8



CR

Martellato / Hammered
H.225 X L.140 mm.
Art. 01.125 ≙ 16 X 8



CR

Martellato / Hammered
H.190 X L.125 mm.
Art. 01.126 ≙ 16 X 8



CR

Martellato / Hammered
H.190 X L.125 mm.
Art. 01.127 ≙ 16 X 8



Martellato / Hammered
H.270 X L.85 mm.
Art. 01.128 ≙ 16 X 8

CR



Martellato / Hammered
H.270 X L.85 mm.
Art. 01.129 ≙ 16 X 8



CR

Martellato / Hammered
H.310 X L.190 mm.
Art. 01.130 ≙ 16 X 8



Art. 01.131



RR

Tondo / Round
H.290 X L.130 mm.
Art. 01.131.01 Ø 10
Art. 01.131.02 Ø 12
Art. 01.131.30 Ø 14
Art. 01.131.31 Ø 16



RR

Tondo / Round
H.360 X L.130 mm.
Art. 01.131.03 Ø 10
Art. 01.131.04 Ø 12
Art. 01.131.32 Ø 14
Art. 01.131.33 Ø 16



RR

Tondo / Round
H.360 X L.130 mm.
Art. 01.131.05 Ø 10
Art. 01.131.06 Ø 12
Art. 01.131.34 Ø 14
Art. 01.131.35 Ø 16

RR



Tondo / Round
H.135 X L.70 mm.
Art. 01.131.07 Ø 10
Art. 01.131.08 Ø 12

RR



Tondo / Round
H.140 X L.85 mm.
Art. 01.131.09 Ø 10
Art. 01.131.10 Ø 12

RR



Tondo / Round
H.230 X L.110 mm.
Art. 01.131.11 Ø 10
Art. 01.131.12 Ø 12
Art. 01.131.36 Ø 14
Art. 01.131.37 Ø 16

RR



Tondo / Round
H.220 X L.110 mm.
Art. 01.131.13 Ø 10
Art. 01.131.14 Ø 12
Art. 01.131.38 Ø 14
Art. 01.131.39 Ø 16

Tutte le parti di questo catalogo - foto comprese - sono di proprietà Euro-Fer. La riproduzione, anche parziale, è vietata in ogni forma e con ogni mezzo. / Every part of this catalogue - photos included - is Euro-Fer's property. All forms of copying are strictly prohibited.

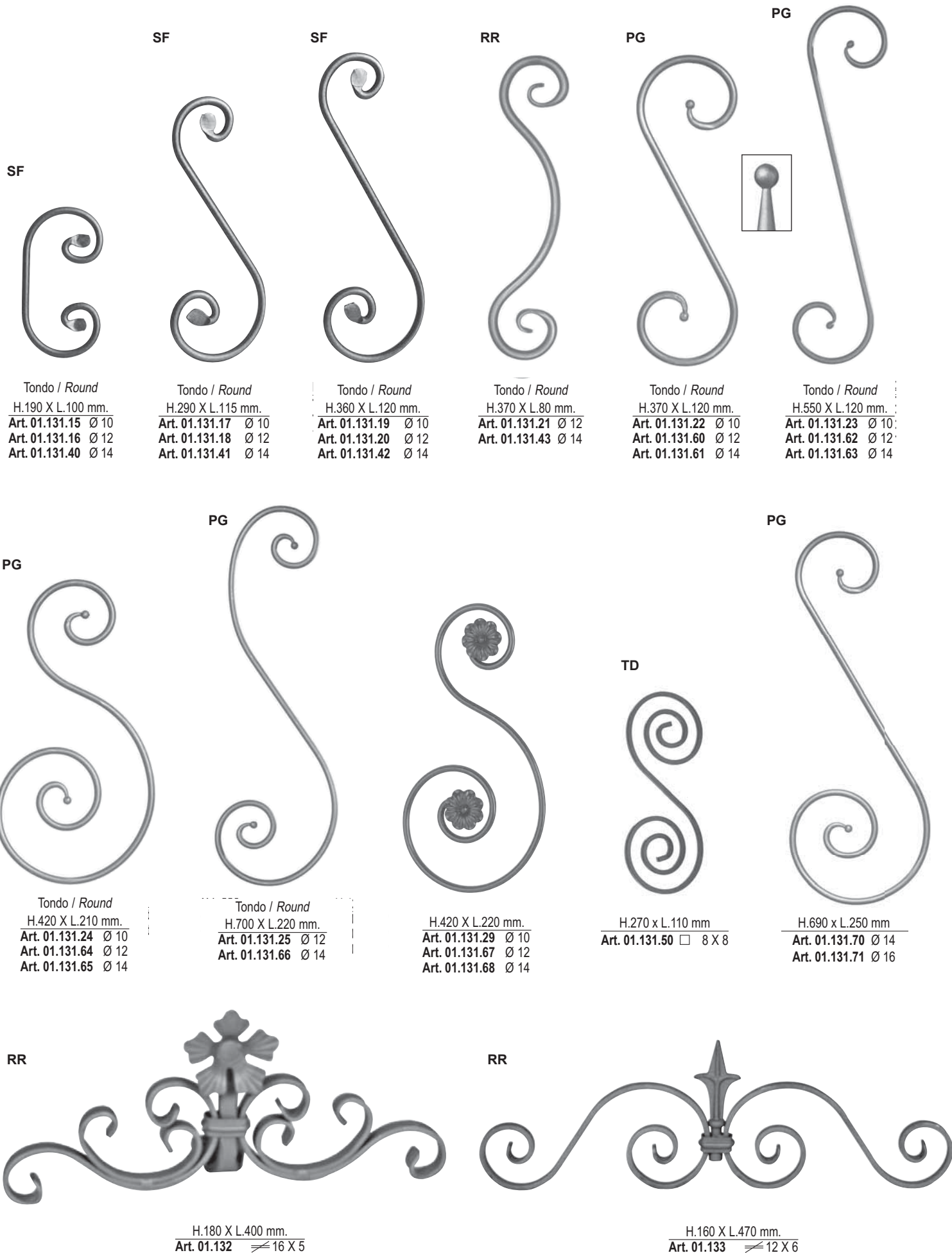

RR



H.200 X L.730 mm.
Art. 01.133.01 ≙ 12 X 6

RR



H.200 X L.770 mm.
Art. 01.134 ≙ 16 X 4

RR



H.250 X L.900 mm.
Art. 01.135 ≙ 16 X 4

RR



H.300 X L.900 mm.
Art. 01.136 ≙ 20 X 5

RR



Modello Scala / Scala Model
H.470 X L.750 mm.
Art. 01.136.01 ≙ 14 X 6

RR



Martellato / Hammered
H.400 X L.950 mm.
Art. 01.136.02 ≙ 25 X 6

RR



Martellato sinistro / Hammered left
H.530 X L.1630 mm.
Art. 01.136.03 ≙ 25 X 6

Martellato destro / Hammered right
H.530 X L.1630 mm.
Art. 01.136.04 ≙ 25 X 6

Tutte le parti di questo catalogo - foto comprese - sono di proprietà Euro-Fer. La riproduzione, anche parziale, è vietata in ogni forma e con ogni mezzo. / Every part of this catalogue - photos included - is Euro-Fer's property. All forms of copying are strictly prohibited.



H.480 - Ø 550
Art. 01.136.05
 Base 40 x 40



H.480 - Ø 550
Art. 01.136.06
 Base 110 x 110



H.580 X L.1250 mm.

Art. 01.136.07 □ 16 X 16 Liscio sinistro / *Smooth left*
Art. 01.136.09 □ 16 X 16 Martellato sinistro / *Hammered left*

H.580 X L.1250 mm.

Art. 01.136.08 □ 16 X 16 Liscio destro / *Smooth right*
Art. 01.136.10 □ 16 X 16 Martellato destro / *Hammered right*

Tutte le parti di questo catalogo - foto comprese - sono di proprietà Euro-Fer. La riproduzione, anche parziale, è vietata in ogni forma e con ogni mezzo. / Every part of this catalogue - photos included - is Euro-Fer's property. All forms of copying are strictly prohibited.



H.560 X L.1720 mm.

Art. 01.136.11 □ 16 X 16 Liscio / Smooth

Art. 01.136.12 □ 16 X 16 Martellato / Hammered

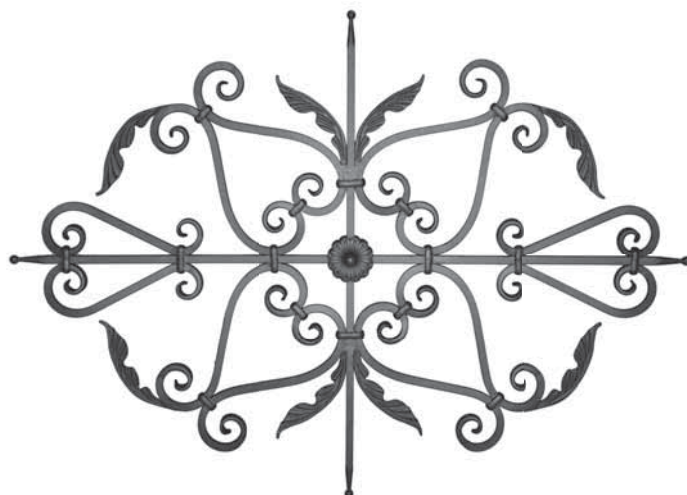

H.1420 X L.1030 mm.

Art. 01.136.13 □ 16 X 16 Liscio / Smooth

Art. 01.136.14 □ 16 X 16 Martellato / Hammered



H.1230 X L.1890 mm.

Art. 01.136.15 □ 16 X 16 Liscio sinistro / Smooth left

Art. 01.136.17 □ 16 X 16 Martellato sinistro / Hammered left



H.1230 X L.1890 mm.

Art. 01.136.16 □ 16 X 16 Liscio destro / Smooth right

Art. 01.136.18 □ 16 X 16 Martellato destro / Hammered right



Tutte le parti di questo catalogo - foto comprese - sono di proprietà Euro-Fer. La riproduzione, anche parziale, è vietata in ogni forma e con ogni mezzo. / Every part of this catalogue - photos included - is Euro-Fer's property. All forms of copying are strictly prohibited.

UR



H.260 x L.100 mm
Liscio / Smooth

Art. 01.136.40 □ 14 X14mm

Art. 01.136.41 □ 12 X12mm

Martellato / Hammered

Art. 01.136.42 □ 14 X14mm

Art. 01.136.43 □ 12 X12mm

UR



H.400 x L.110 mm
Liscio / Smooth

Art. 01.136.46 □ 14 X14mm

Art. 01.136.47 □ 12 X12mm

Martellato / Hammered

Art. 01.136.48 □ 14 X14mm

Art. 01.136.49 □ 12 X12mm

UR



H.200 X L.95 mm.

Art. 01.137 □ 16 X 16

UR



Martellato / Hammered

H.200 X L.95 mm.

Art. 01.138 □ 16 X 16

UR



H.200 X L.95 mm.

Art. 01.139 □ 16 X 16

UR



Martellato / Hammered

H.200 X L.95 mm.

Art. 01.140 □ 16 X 16

UR



H.220 X L.115 mm.

Art. 01.141 □ 16 X 16

UR



Martellato / Hammered

H.220 X L.115 mm.

Art. 01.142 □ 16 X 16

UR



H.240 X L.160 mm.

Art. 01.143 □ 16 X 16

UR



Martellato / Hammered

H.240 X L.160 mm.

Art. 01.144 □ 16 X 16

UR



H.270 X L.100 mm.

Art. 01.145 □ 16 X 16

UR



Martellato / Hammered

H.270 X L.100 mm.

Art. 01.146 □ 16 X 16

UR



H.260 X L.135 mm.

Art. 01.147 □ 16 X 16

UR



Martellato / Hammered

H.260 X L.135 mm.

Art. 01.148 □ 16 X 16

UR



H.280 X L.105 mm.

Art. 01.149 □ 16 X 16

UR



Martellato / Hammered

H.280 X L.105 mm.

Art. 01.150 □ 16 X 16

UR



H.370 X L.190 mm.

Art. 01.151 □ 16 X 16

UR



Martellato / Hammered

H.370 X L.190 mm.

Art. 01.152 □ 16 X 16

UR



H.450 X L.200 mm.

Art. 01.153 □ 16 X 16

UR



Martellato / Hammered

H.450 X L.200 mm.

Art. 01.154 □ 16 X 16

UR



H.490 X L.170 mm.

Art. 01.155 □ 16 X 16

UR



Martellato / Hammered

H.490 X L.170 mm.

Art. 01.156 □ 16 X 16

UR



H.510 X L.195 mm.

Art. 01.157 □ 16 X 16

UR



Martellato / Hammered

H.510 X L.195 mm.

Art. 01.158 □ 16 X 16

Tutte le parti di questo catalogo - foto comprese - sono di proprietà Euro-Fer. La riproduzione, anche parziale, è vietata in ogni forma e con ogni mezzo. / Every part of this catalogue - photos included - is Euro-Fer's property. All forms of copying are strictly prohibited.



H.540 X L.200 mm.
Art. 01.159 □ 16 X 16



Martellato / Hammered
H.540 X L.200 mm.
Art. 01.160 □ 16 X 16



H.810 X L.540 mm.
Art. 01.161 □ 16 X 16



Martellato / Hammered
H.810 X L.540 mm.
Art. 01.162 □ 16 X 16



H.200 X L.85 mm.
Art. 01.163 □ 16 X 16



Martellato / Hammered
H.200 X L.85 mm.
Art. 01.164 □ 16 X 16



H.260 X L.95 mm.
Art. 01.165 □ 16 X 16



Martellato / Hammered
H.260 X L.95 mm.
Art. 01.166 □ 16 X 16



H.365 X L.170 mm.
Art. 01.167 □ 16 X 16



Martellato / Hammered
H.365 X L.170 mm.
Art. 01.168 □ 16 X 16



H.400 X L.185 mm.
Art. 01.169 □ 16 X 16

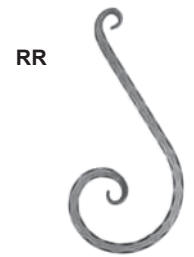

Martellato / Hammered
H.400 X L.185 mm.
Art. 01.170 □ 16 X 16



H.415 X L.190 mm.
Art. 01.171 □ 16 X 16



Martellato / Hammered
H.415 X L.190 mm.
Art. 01.172 □ 16 X 16



H.420 X L.150 mm.
Art. 01.173 □ 16 X 16



Martellato / Hammered
H.420 X L.150 mm.
Art. 01.174 □ 16 X 16



H.430 X L.205 mm.
Art. 01.175 □ 16 X 16



Martellato / Hammered
H.430 X L.205 mm.
Art. 01.176 □ 16 X 16



H.450 X L.180 mm.
Art. 01.177 □ 16 X 16



Martellato / Hammered
H.450 X L.180 mm.
Art. 01.178 □ 16 X 16



H.480 X L.140 mm.
Art. 01.179 □ 16 X 16



Martellato / Hammered
H.480 X L.140 mm.
Art. 01.180 □ 16 X 16



H.480 X L.160 mm.
Art. 01.181 □ 16 X 16



Martellato / Hammered
H.480 X L.160 mm.
Art. 01.182 □ 16 X 16

Tutte le parti di questo catalogo - foto comprese - sono di proprietà Euro-Fer. La riproduzione, anche parziale, è vietata in ogni forma e con ogni mezzo. / Every part of this catalogue - photos included - is Euro-Fer's property. All forms of copying are strictly prohibited.



Tutte le parti di questo catalogo - foto comprese - sono di proprietà Euro-Fer. La riproduzione, anche parziale, è vietata in ogni forma e con ogni mezzo. / Every part of this catalogue - photos included - is Euro-Fer's property. All forms of copying are strictly prohibited.

RR



H.660 X L.170 mm.
Art. 01.195 □ 16 X 16

RR



Martellato / Hammered
H.660 X L.170 mm.
Art. 01.196 □ 16 X 16

RR



H.670 X L.200 mm.
Art. 01.197 □ 16 X 16

RR



Martellato / Hammered
H.670 X L.200 mm.
Art. 01.198 □ 16 X 16

RR



H.700 X L.330 mm.
Art. 01.199 □ 16 X 16

RR



Martellato / Hammered
H.700 X L.330 mm.
Art. 01.200 □ 16 X 16

RR



H.920 X L.310 mm.
Art. 01.201 □ 16 X 16

RR



Martellato / Hammered
H.920 X L.310 mm.
Art. 01.202 □ 16 X 16

RR



H.920 X L.530 mm.
Art. 01.203 □ 16 X 16

RR



Martellato / Hammered
H.920 X L.530 mm.
Art. 01.204 □ 16 X 16

RR



H.1020 X L.360 mm.
Art. 01.205 □ 16 X 16

RR



Martellato / Hammered
H.1020 X L.360 mm.
Art. 01.206 □ 16 X 16



Tutte le parti di questo catalogo - foto comprese - sono di proprietà Euro-Fer. La riproduzione, anche parziale, è vietata in ogni forma e con ogni mezzo. / Every part of this catalogue - photos included - is Euro-Fer's property. All forms of copying are strictly prohibited.

RR



H.170 X L.100 mm.
Art. 01.207 □ 16 X 16

RR



Martellato / Hammered
H.170 X L.100 mm.
Art. 01.208 □ 16 X 16

RR



H.210 X L.115 mm.
Art. 01.209 □ 16 X 16

RR



Martellato / Hammered
H.210 X L.115 mm.
Art. 01.210 □ 16 X 16

RR



H.220 X L.170 mm.
Art. 01.211 □ 16 X 16

RR



Martellato / Hammered
H.220 X L.170 mm.
Art. 01.212 □ 16 X 16

RR



H.250 X L.180 mm.
Art. 01.213 □ 16 X 16

RR



Martellato / Hammered
H.250 X L.180 mm.
Art. 01.214 □ 16 X 16

RR



H.270 X L.190 mm.
Art. 01.215 □ 16 X 16

RR



Martellato / Hammered
H.270 X L.190 mm.
Art. 01.216 □ 16 X 16

RR



H.280 X L.150 mm.
Art. 01.217 □ 16 X 16

RR



Martellato / Hammered
H.280 X L.150 mm.
Art. 01.218 □ 16 X 16

RR



H.310 X L.200 mm.
Art. 01.219 □ 16 X 16

RR



Martellato / Hammered
H.310 X L.200 mm.
Art. 01.220 □ 16 X 16

RR



H.320 X L.210 mm.
Art. 01.221 □ 16 X 16

RR



Martellato / Hammered
H.320 X L.210 mm.
Art. 01.222 □ 16 X 16

RR



H.320 X L.205 mm.
Art. 01.223 □ 16 X 16

RR



H.320 X L.240 mm.
Art. 01.225 □ 16 X 16

RR



Martellato / Hammered
H.320 X L.240 mm.
Art. 01.226 □ 16 X 16

RR



H.350 X L.260 mm.
Art. 01.227 □ 16 X 16

RR



Martellato / Hammered
H.350 X L.260 mm.
Art. 01.228 □ 16 X 16

RR



H.350 X L.280 mm.
Art. 01.229 □ 16 X 16

RR



Martellato / Hammered
H.350 X L.280 mm.
Art. 01.230 □ 16 X 16

RR



H.420 X L.310 mm.
Art. 01.231 □ 16 X 16



Tutte le parti di questo catalogo - foto comprese - sono di proprietà Euro-Fer. La riproduzione, anche parziale, è vietata in ogni forma e con ogni mezzo. / Every part of this catalogue - photos included - is Euro-Fer's property. All forms of copying are strictly prohibited.



H.450 X L.330 mm.
Art. 01.233 □ 16 X 16



Martellato / Hammered
H.450 X L.330 mm.
Art. 01.234 □ 16 X 16



H.480 X L.230 mm.
Art. 01.235 □ 16 X 16



Martellato / Hammered
H.480 X L.230 mm.
Art. 01.236 □ 16 X 16



H.510 X L.210 mm.
Art. 01.237 □ 16 X 16

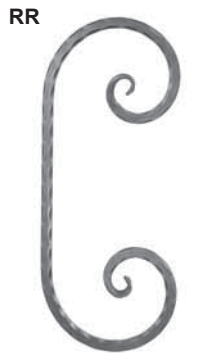

Martellato / Hammered
H.510 X L.210 mm.
Art. 01.238 □ 16 X 16



H.540 X L.300 mm.
Art. 01.239 □ 16 X 16



Martellato / Hammered
H.540 X L.300 mm.
Art. 01.240 □ 16 X 16



H.580 X L.410 mm.
Art. 01.241 □ 16 X 16



Martellato / Hammered
H.580 X L.410 mm.
Art. 01.242 □ 16 X 16



H.200 X L.85 mm.
Art. 01.243 □ 10 X 10



H.240 X L.110 mm.
Art. 01.244 □ 10 X 10



H.250 X L.110 mm.
Art. 01.245 □ 10 X 10



H.270 X L.135 mm.
Art. 01.246 □ 10 X 10



H.350 X L.135 mm.
Art. 01.247 □ 10 X 10



H.420 X L.150 mm.
Art. 01.248 □ 10 X 10



H.470 X L.220 mm.
Art. 01.249 □ 10 X 10



H.450 X L.135 mm.
Art. 01.250 □ 10 X 10



H.330 X L.230 mm.
Art. 01.251 □ 10 X 10



H.440 X L.290 mm.
Art. 01.252 □ 10 X 10



H.540 X L.250 mm.
Art. 01.253 □ 10 X 10



H.570 X L.350 mm.
Art. 01.254 □ 10 X 10



Forgiato / Forged
H.360 X L.125 mm.
Art. 01.255 □ 14 X 14



Forgiato / Forged
H.360 X L.125 mm.
Art. 01.256 □ 14 X 14

Tutte le parti di questo catalogo - foto comprese - sono di proprietà Euro-Fer. La riproduzione, anche parziale, è vietata in ogni forma e con ogni mezzo. / Every part of this catalogue - photos included - is Euro-Fer's property. All forms of copying are strictly prohibited.

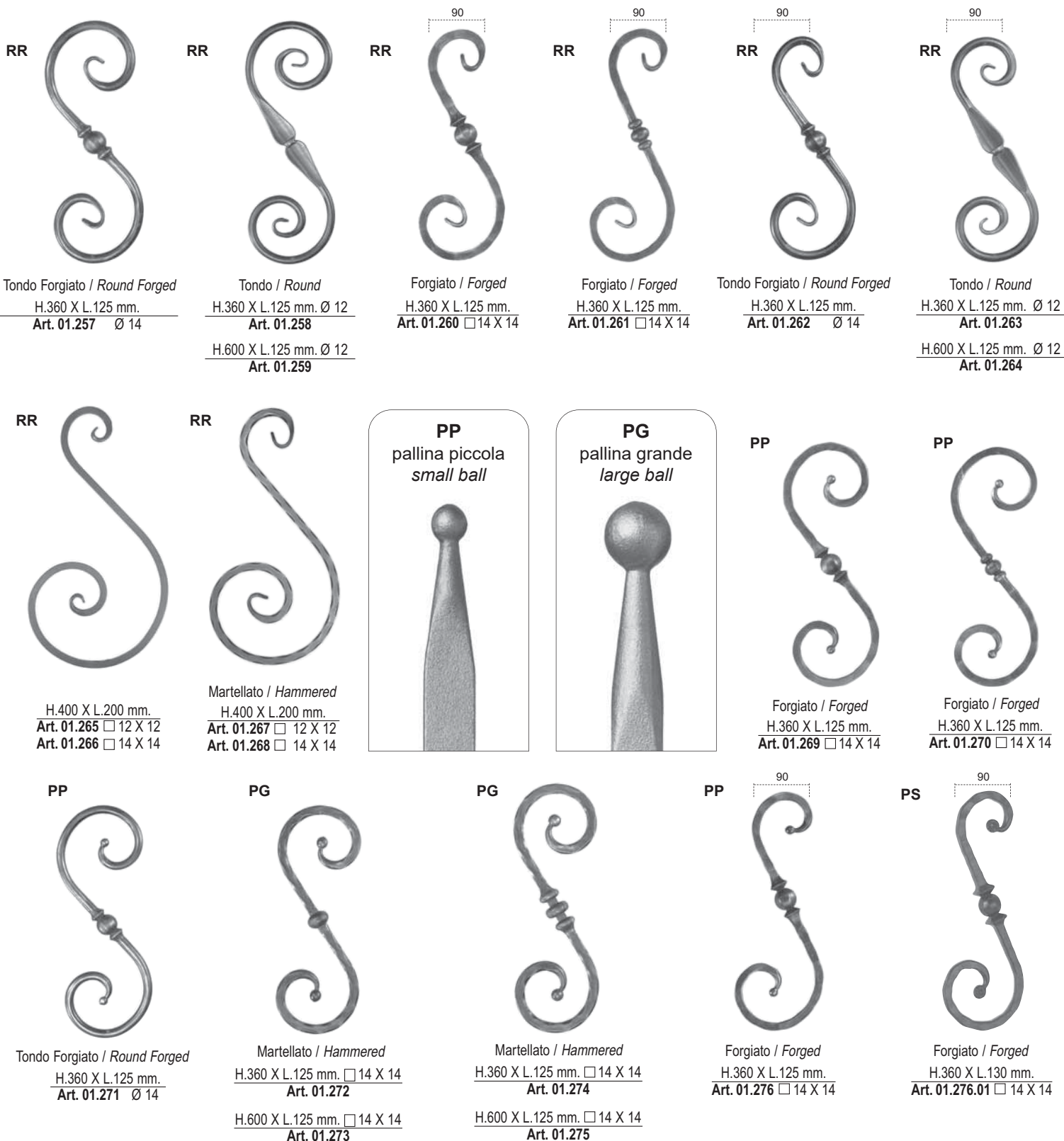

Tutte le parti di questo catalogo - foto comprese - sono di proprietà Euro-Fer. La riproduzione, anche parziale, è vietata in ogni forma e con ogni mezzo. / Every part of this catalogue - photos included - is Euro-Fer's property. All forms of copying are strictly prohibited.



PP
Forgiato / Forged
H.360 X L.125 mm.
Art. 01.277 □ 14 X 14



PP
Tondo Forgiato / Round Forged
H.360 X L.125 mm.
Art. 01.278 Ø 14



PG
Martellato / Hammered
H.360 X L.125 mm.
Art. 01.279 □ 14 X 14



PG
Martellato / Hammered
H.360 X L.125 mm.
Art. 01.281 □ 14 X 14



PG
Martellato / Hammered □ 12 X 12
Art. 01.283 H.360 X L.125 mm.
Art. 01.284 H.600 X L.125 mm

H.600 X L.125 mm.
Art. 01.280 □ 14 X 14

H.600 X L.125 mm.
Art. 01.282 □ 14 X 14

Martellato / Hammered □ 14 X 14
Art. 01.285 H.360 X L.125 mm
Art. 01.286 H.600 X L.125 mm



PG
□ 12 X 12
Art. 01.287 H.360 X L.125 mm.
Art. 01.288 H.600 X L.125 mm
□ 14 X 14
Art. 01.289 H.360 X L.125 mm
Art. 01.290 H.600 X L.125 mm



PG
Martellato / Hammered
H.250 X L.150 mm.
Art. 01.291 □ 12 X 12
Art. 01.292 □ 14 X 14



CR
chiocciola rigata
fluted spiral



CR
Mod. Scala / Scala Model
H.115 X L.75 mm.
Art. 01.293 □ 8 X 8



CR
Modello Scala / Scala Model
H.180 X L.90 mm.
Art. 01.294 ≡ 12 X 6
Art. 01.295 ≡ 14 X 6
Art. 01.295.01 ≡ 16 X 6



CR
Modello Scala / Scala Model
H.280 X L.125 mm.
Art. 01.296 ≡ 12 X 6
Art. 01.297 ≡ 14 X 6
Art. 01.297.01 ≡ 16 X 6



CR
Modello Scala / Scala Model
H.350 X L.135 mm.
Art. 01.298 ≡ 12 X 6
Art. 01.299 ≡ 14 X 6
Art. 01.299.01 ≡ 16 X 6



CR
Modello Scala / Scala Model
H.450 X L.145 mm.
Art. 01.300 ≡ 12 X 6
Art. 01.301 ≡ 14 X 6
Art. 01.301.01 ≡ 16 X 6



CR
Modello Scala / Scala Model
H.280 X L.125 mm.
Art. 01.302 ≡ 12 X 6
Art. 01.303 ≡ 14 X 6
Art. 01.303.01 ≡ 16 X 6



CR
Modello Scala / Scala Model
H.350 X L.135 mm.
Art. 01.304 ≡ 12 X 6
Art. 01.305 ≡ 14 X 6
Art. 01.305.01 ≡ 16 X 6



CR
Modello Scala / Scala Model
H.450 X L.145 mm.
Art. 01.306 ≡ 12 X 6
Art. 01.307 ≡ 14 X 6
Art. 01.307.01 ≡ 16 X 6

Tutte le parti di questo catalogo - foto comprese - sono di proprietà Euro-Fer. La riproduzione, anche parziale, è vietata in ogni forma e con ogni mezzo. / Every part of this catalogue - photos included - is Euro-Fer's property. All forms of copying are strictly prohibited.

CR



H.125 X L.80 mm.

Art. 01.308 ≙ 12 X 6
Art. 01.309 ≙ 14 X 6

CR



H.145 X L.70 mm.

Art. 01.310 ≙ 12 X 6
Art. 01.311 ≙ 14 X 6

CR



H.250 X L.130 mm.

Art. 01.312 ≙ 12 X 6
Art. 01.313 ≙ 14 X 6

CR



Tondo / Round

H.290 X L.115 mm.
Art. 01.314 Ø 12
Art. 01.314.01 Ø 14

CR



Tondo / Round

H.350 X L.125 mm.
Art. 01.315 Ø 12
Art. 01.315.01 Ø 14

CR



Tondo / Round

H.500 X L.100 mm.
Art. 01.321 Ø 12
Art. 01.321.01 Ø 14

CR



Tondo / Round

H.390 X L.130 mm.
Art. 01.316 Ø 12
Art. 01.316.01 Ø 14

CR



Tondo / Round

H.450 X L.130 mm.
Art. 01.317 Ø 12
Art. 01.317.01 Ø 14

CR



Tondo / Round

H.180 X L.105 mm.
Art. 01.318 Ø 12
Art. 01.318.01 Ø 14

CR



Tondo / Round

H.220 X L.110 mm.
Art. 01.319 Ø 12
Art. 01.319.01 Ø 14

CR



Tondo / Round

H.190 X L.105 mm.
Art. 01.320 Ø 12
Art. 01.320.01 Ø 14

CR

Tondo Martellato
Hammered RoundH.290 X L.115 mm.
Art. 01.322 Ø 12
Art. 01.322.01 Ø 14

CR

Tondo Martellato
Hammered RoundH.350 X L.125 mm.
Art. 01.323 Ø 12
Art. 01.323.01 Ø 14

CR

Tondo Martellato
Hammered RoundH.390 X L.130 mm.
Art. 01.324 Ø 12
Art. 01.324.01 Ø 14

CR

Tondo Martellato
Hammered RoundH.450 X L.130 mm.
Art. 01.325 Ø 12
Art. 01.325.01 Ø 14

CR

Tondo Martellato
Hammered RoundH.180 X L.105 mm.
Art. 01.326 Ø 12
Art. 01.326.01 Ø 14

CR

Tondo Martellato
Hammered RoundH.220 X L.110 mm.
Art. 01.327 Ø 12
Art. 01.327.01 Ø 14

CR

Tondo Martellato
Hammered RoundH.190 X L.105 mm.
Art. 01.328 Ø 12
Art. 01.328.01 Ø 14

CR

Tondo Martellato
Hammered RoundH.500 X L.100 mm.
Art. 01.329 Ø 12

RR



Martellato / Hammered

H.380 X L.200 mm.
Art. 01.330 ≙ 25 X 6

RR



Martellato / Hammered

H.470 X L.270 mm.
Art. 01.331 ≙ 25 X 6

RR



Martellato / Hammered

H.640 X L.130 mm.
Art. 01.332 ≙ 25 X 6

RR



Martellato / Hammered

H.300 X L.150 mm.
Art. 01.333 ≙ 25 X 6



Martellato / Hammered
H.710 X L.305 mm.
Art. 01.334 \neq 25 X 6



Martellato / Hammered
H.700 X L.300 mm.
Art. 01.335 \neq 25 X 6



Martellato / Hammered
H.170 X L.115 mm.
Art. 01.336 \square 12 X 12
Art. 01.337 \square 14 X 14

Liscio / Smooth
H.170 X L.115 mm.
Art. 01.338 \square 12 X 12
Art. 01.339 \square 14 X 14



Tondo / Round
H.200 X L.135 mm.
Art. 01.340 \varnothing 12
Art. 01.341 \varnothing 14
Art. 01.342 \varnothing 16



Liscio / Smooth
H.200 X L.135 mm.
Art. 01.343 \square 12 X 12
Art. 01.344 \square 14 X 14
Art. 01.345 \square 16 X 16



Martellato / Hammered
H.360 X L.130 mm.
Art. 01.349 \square 12 X 12
Art. 01.350 \square 14 X 14

Liscio / Smooth
H.360 X L.130 mm.
Art. 01.351 \square 12 X 12
Art. 01.352 \square 14 X 14



Tondo / Round
H.350 X L.150 mm.
Art. 01.353 \varnothing 12
Art. 01.354 \varnothing 14
Art. 01.355 \varnothing 16



Liscio / Smooth
H.350 X L.150 mm.
Art. 01.356 \square 12 X 12
Art. 01.357 \square 14 X 14
Art. 01.358 \square 16 X 16

Martellato / Hammered
H.350 X L.150 mm.
Art. 01.359 \square 12 X 12
Art. 01.360 \square 14 X 14
Art. 01.361 \square 16 X 16



Liscio / Smooth
H.350 X L.150 mm.
Art. 01.362 \square 12 X 12
Art. 01.363 \square 14 X 14
Art. 01.364 \square 16 X 16

Martellato / Hammered
H.350 X L.150 mm.
Art. 01.365 \square 12 X 12
Art. 01.366 \square 14 X 14
Art. 01.367 \square 16 X 16



Tondo / Round
H.350 X L.150 mm.
Art. 01.368 \varnothing 12
Art. 01.369 \varnothing 14
Art. 01.370 \varnothing 16



Liscio / Smooth
H.135 X L.80 mm.
Art. 01.371 \neq 14 X 6



Liscio / Smooth
H.145 X L.90 mm.
Art. 01.372 \varnothing 10
Art. 01.372.01 \varnothing 12



Liscio / Smooth
H.290 X L.120 mm.
Art. 01.373 \neq 14 X 6



Mod. Scala / Scala model
H.290 X L.120 mm.
Art. 01.374 \neq 14 X 6



Liscio / Smooth
H.220 X L.110 mm.
Art. 01.375 \neq 14 X 6



Liscio / Smooth
H.200 X L.100 mm.
Art. 01.376 \neq 14 X 6
Art. 01.376.02 \neq 16 X 8



Liscio / Smooth
H.250 X L.75 mm.
Art. 01.377 \neq 14 X 6

Tutte le parti di questo catalogo - foto comprese - sono di proprietà Euro-Fer. La riproduzione, anche parziale, è vietata in ogni forma e con ogni mezzo. / Every part of this catalogue - photos included - is Euro-Fer's property. All forms of copying are strictly prohibited.

PS
pallina "a sole"
sun ball



PS



Liscio / Smooth
H.135 X L.80 mm.
Art. 01.400 ≙ 14 X 6

PS



Liscio / Smooth
H.190 X L.65 mm.
Art. 01.401 □ 8 X 8



PS



Liscio / Smooth
H.200 X L.100 mm.
Art. 01.402 ≙ 14 X 6



PS



Liscio / Smooth
H.220 X L.110 mm.
Art. 01.403 ≙ 14 X 6

PS



Liscio / Smooth
H.360 X L.125 mm.
Art. 01.404 □ 12 X 12
Art. 01.404.01 □ 14 X 14
Art. 01.404.02 □ 16 X 16

PS



Liscio / Smooth
H.350 X L.150 mm.
Art. 01.405 □ 12 X 12
Art. 01.405.01 □ 14 X 14
Art. 01.405.02 □ 16 X 16

PS



Liscio / Smooth
H.350 X L.150 mm.
Art. 01.406 Ø 12
Art. 01.406.01 Ø 14

PS



Liscio / Smooth
H.420 X L.220 mm.
Art. 01.407 Ø 10
Art. 01.407.01 Ø 12
Art. 01.407.02 Ø 14

PS



Liscio / Smooth
H.550 X L.125 mm.
Art. 01.408 Ø 10
Art. 01.408.01 Ø 12
Art. 01.408.02 Ø 14
Art. 01.408.03 Ø 16

PS



Liscio / Smooth
H.250 X L.75 mm.
Art. 01.409 ≙ 14 X 6



RR



Rigato -Martellato-Attorcigliato
Fluted-Hammered and Twisted
H.800 X L.220 mm.
Art. 01.450 □ 14 X 14



RR



Rigato -Martellato-Attorcigliato
Fluted-Hammered and Twisted
H.500 X L.145 mm.
Art. 01.451 □ 14 X 14



RR



Rigato -Martellato-Attorcigliato
Fluted-Hammered and Twisted
H.330 X L.130 mm.
Art. 01.452 □ 14 X 14



CS
chiocciola schiacciata
pressed spiral



CS
Liscio / Smooth
H.200 x L.125 mm
Art. 01.490 Ø 14
Art. 01.491 Ø 16
Art. 01.492 Ø 18
Art. 01.493 Ø 20

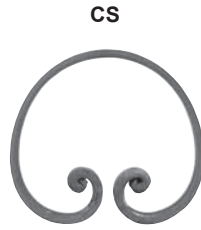

CS
Liscio / Smooth
H.160 x L.175 mm
Art. 01.500 □ 12X12
Art. 01.501 ≧ 16x8
Art. 01.502 ≧ 20x10
Art. 01.503 Ø 10



CS
Liscio / Smooth
H.155 X L.95 mm.
Art. 01.504 □ 12 X 12
Art. 01.505 ≧ 16 X 8
Art. 01.506 ≧ 20 X 10
Art. 01.507 Ø 10



CS
Liscio / Smooth
H.270 X L.85 mm.
Art. 01.508 □ 12 X 12
Art. 01.509 ≧ 16 X 8
Art. 01.510 ≧ 20 X 10
Art. 01.511 Ø 10



CS
Liscio / Smooth
H.180 X L.90 mm.
Art. 01.512 □ 12 X 12
Art. 01.513 ≧ 16 X 8
Art. 01.514 ≧ 20 X 10
Art. 01.515 Ø 10



CS
Liscio / Smooth
H.290 X L.115 mm.
Art. 01.516 □ 12 X 12
Art. 01.517 ≧ 16 X 8
Art. 01.518 ≧ 20 X 10
Art. 01.519 Ø 10



CS
Liscio / Smooth
H.350 x L.110 mm
Art. 01.519.10 □ 16 X16



CS
Liscio / Smooth
H.420 x L.165 mm
Art. 01.519.15 □ 16 X16



CS
Liscio / Smooth
H.120 X L.70 mm.
Art. 01.520 Ø 10



CS
Liscio / Smooth
H.140 X L.70 mm.
Art. 01.521 Ø 10



CS
Liscio / Smooth
H.140 X L.80 mm.
Art. 01.522 Ø 10



CS
Liscio / Smooth
H.210 x L.140 mm
Art. 01.522.05 Ø 10
Art. 01.522.06 □ 12
Art. 01.522.07 ≧ 16 x 8
Art. 01.522.08 ≧ 20 x 10



CS
Liscio / Smooth
H.410 x L.270 mm
Art. 01.522.10 Ø 10
Art. 01.522.11 □ 12
Art. 01.522.12 ≧ 20 x 10
Art. 01.522.13 ≧ 16 x 8



RR



Liscio / Smooth
H.294 x L.100 mm

Art. 01.523 ≙ 14 X 6

Art. 01.523.01 ≙ 16 X 6

Art. 01.523.02 ≙ 16 X 8 **NEW**



RR



Mod. Scala / Scala Model
H.294 x L.100 mm

Art. 01.524 ≙ 14 X 6

Art. 01.524.01 ≙ 16 X 6

Art. 01.524.02 ≙ 16 X 8 **NEW**

RR



Liscio / Smooth
H.200 x L.200 mm
Art. 01.525 ≙ 12 x 6



Liscio / Smooth
H.120 x L.100 mm
Art. 01.526 ≙ 12 x 6
H.125 x L.100 mm
Art. 01.527 □ 12

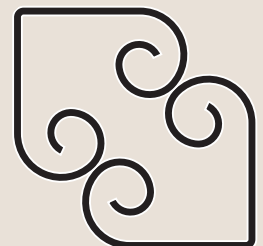
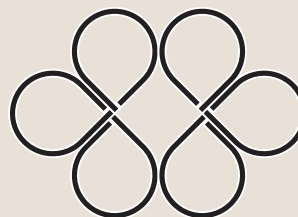
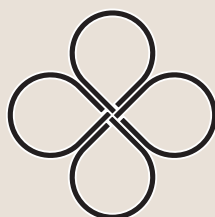
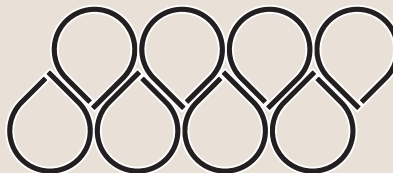
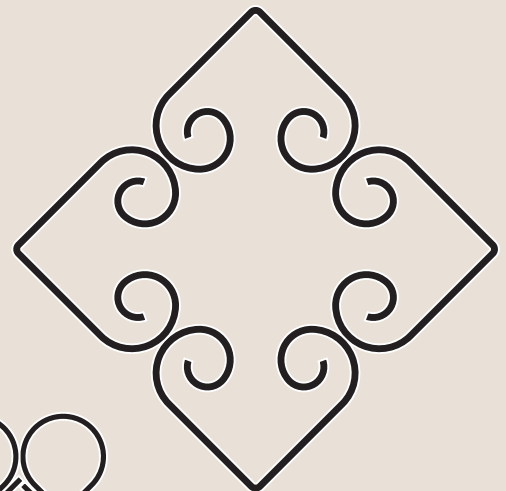
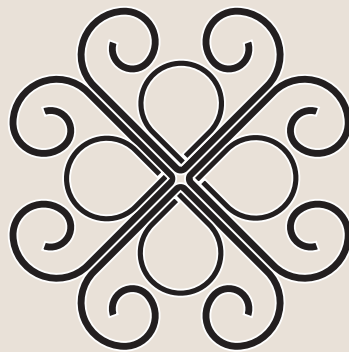

RR



Liscio / Smooth
H.750 X L.260 mm.
Art. 01.528 ≙ 30 X 8

TA



H.500 X L.100 mm.
Art. 01.529 ≙ 12 X 3

RR



H.650 X L.170 mm.
Art. 01.530 ≙ 16 X 6

RR



H.780 X L.280 mm.
Art. 01.531 Ø 25



Tutte le parti di questo catalogo - foto comprese - sono di proprietà Euro-Fer. La riproduzione, anche parziale, è vietata in ogni forma e con ogni mezzo. / Every part of this catalogue - photos included - is Euro-Fer's property. All forms of copying are strictly prohibited.

N.B. Tutti i cerchi non sono saldati
 NOTE: All the circles are not welded.

H: Diametro esterno / External diameter



Cerchi con sezione in tondo e tondo martellato
 Round section circles and hammered circles

Ø 8 mm.	
Art. 02.001	H 100 mm.
Art. 02.002	H 120 mm.
Art. 02.003	H 130 mm.
Art. 02.003.01	H 90 mm.
Art. 02.003.02	H 105 mm.
Art. 02.003.03	H 110 mm.
Art. 02.003.04	H 135 mm.
Art. 02.003.05	H 180 mm.
Art. 02.003.06	H 250 mm.
Art. 02.003.07	H 270 mm.

Ø 10 mm.	
Art. 02.004	H 100 mm.
Art. 02.005	H 120 mm.
Art. 02.006	H 130 mm.
Art. 02.006.01	H 90 mm.
Art. 02.006.02	H 110 mm.
Art. 02.006.03	H 135 mm.
Art. 02.006.04	H 140 mm.
Art. 02.006.05	H 180 mm.
Art. 02.006.06	H 250 mm.
Art. 02.006.07	H 270 mm.

Ø 12 mm.	
Art. 02.006.50	H 115 mm.
Art. 02.007	H 100 mm.
Art. 02.008	H 120 mm.
Art. 02.009	H 130 mm.
Art. 02.009.01	H 110 mm.
Art. 02.009.02	H 135 mm.
Art. 02.009.03	H 140 mm.
Art. 02.009.04	H 180 mm.
Art. 02.009.05	H 210 mm.
Art. 02.009.06	H 250 mm.
Art. 02.009.07	H 275 mm.

Mart. a caldo / Hot hammered Ø 12 mm.	
Art. 02.007.01	H 100 mm.
Art. 02.007.02	H 110 mm.
Art. 02.007.03	H 120 mm.
Art. 02.007.04	H 130 mm.
Art. 02.007.05	H 135 mm.
Art. 02.007.06	H 140 mm.
Art. 02.007.07	H 180 mm.
Art. 02.007.08	H 210 mm.
Art. 02.007.09	H 250 mm.
Art. 02.007.10	H 275 mm.

Ø 14 mm.	
Art. 02.009.08	H 100 mm.
Art. 02.009.09	H 110 mm.
Art. 02.009.10	H 115 mm.
Art. 02.009.11	H 120 mm.
Art. 02.009.12	H 125 mm.
Art. 02.009.13	H 130 mm.
Art. 02.009.14	H 135 mm.
Art. 02.009.15	H 140 mm.
Art. 02.009.16	H 160 mm.
Art. 02.009.17	H 180 mm.
Art. 02.009.18	H 250 mm.

Mart. a caldo / Hot hammered Ø 14 mm.	
Art. 02.009.26	H 100 mm.
Art. 02.009.27	H 110 mm.
Art. 02.009.28	H 115 mm.
Art. 02.009.29	H 120 mm.
Art. 02.009.30	H 125 mm.
Art. 02.009.31	H 130 mm.
Art. 02.009.32	H 135 mm.
Art. 02.009.33	H 140 mm.
Art. 02.009.34	H 160 mm.
Art. 02.009.35	H 180 mm.
Art. 02.009.36	H 250 mm.

Ø 16 mm.	
Art. 02.009.19	H 100 mm.
Art. 02.009.20	H 110 mm.
Art. 02.009.21	H 120 mm.
Art. 02.009.22	H 135 mm.
Art. 02.009.23	H 140 mm.
Art. 02.009.24	H 180 mm.
Art. 02.009.25	H 250 mm.

Mart. a caldo / Hot hammered Ø 16 mm.	
Art. 02.009.37	H 100 mm.
Art. 02.009.38	H 110 mm.
Art. 02.009.39	H 120 mm.
Art. 02.009.40	H 135 mm.
Art. 02.009.41	H 140 mm.
Art. 02.009.42	H 180 mm.
Art. 02.009.43	H 250 mm.



Cerchi con sezione in quadro
Square section circles

□ 8 X 8 mm.	
Art. 02.010	H 100 mm.
Art. 02.011	H 120 mm.
Art. 02.012	H 130 mm.
Art. 02.012.01	H 90 mm.
Art. 02.012.02	H 105 mm.
Art. 02.012.03	H 110 mm.
Art. 02.012.04	H 135 mm.
Art. 02.012.05	H 180 mm.
Art. 02.012.06	H 250 mm.
Art. 02.012.07	H 270 mm.

□ 12 X 12 mm.	
Art. 02.016	H 100 mm.
Art. 02.017	H 120 mm.
Art. 02.018	H 130 mm.
Art. 02.018.01	H 110 mm.
Art. 02.018.02	H 135 mm.
Art. 02.018.03	H 140 mm.
Art. 02.018.04	H 180 mm.
Art. 02.018.05	H 210 mm.
Art. 02.018.06	H 250 mm.
Art. 02.018.07	H 275 mm.

□ 16 X 16 mm.	
Art. 02.018.19	H 100 mm.
Art. 02.018.20	H 110 mm.
Art. 02.018.21	H 120 mm.
Art. 02.018.22	H 135 mm.
Art. 02.018.23	H 140 mm.
Art. 02.018.24	H 180 mm.
Art. 02.018.25	H 250 mm.

□ 10 X 10 mm.	
Art. 02.013	H 100 mm.
Art. 02.014	H 120 mm.
Art. 02.015	H 130 mm.
Art. 02.015.01	H 90 mm.
Art. 02.015.02	H 110 mm.
Art. 02.015.03	H 135 mm.
Art. 02.015.04	H 140 mm.
Art. 02.015.05	H 180 mm.
Art. 02.015.06	H 250 mm.
Art. 02.015.07	H 270 mm.

□ 14 X 14 mm.	
Art. 02.018.08	H 100 mm.
Art. 02.018.09	H 110 mm.
Art. 02.018.10	H 115 mm.
Art. 02.018.11	H 120 mm.
Art. 02.018.12	H 125 mm.
Art. 02.018.13	H 130 mm.
Art. 02.018.14	H 135 mm.
Art. 02.018.15	H 140 mm.
Art. 02.018.16	H 160 mm.
Art. 02.018.17	H 180 mm.
Art. 02.018.18	H 250 mm.

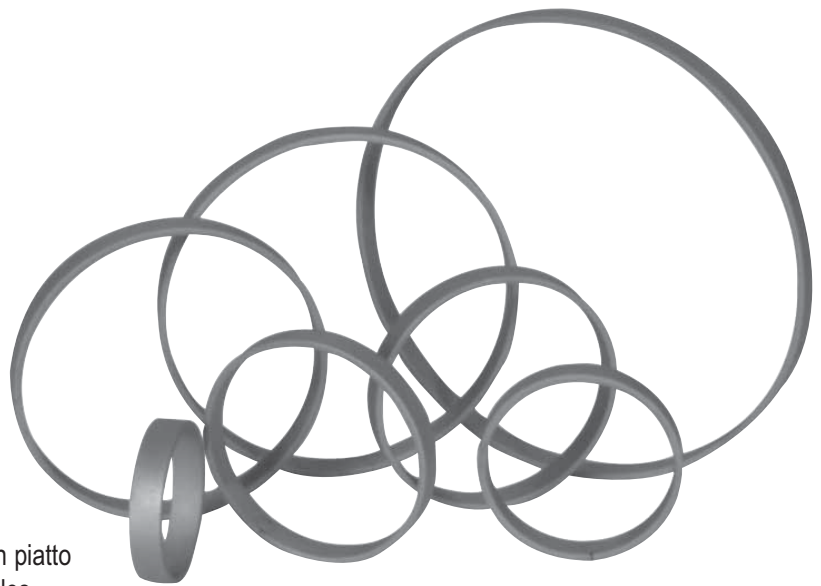

Cerchi con sezione in piatto
Flat section circles

≠ 16 X 4 mm.	
Art. 02.019	H 100 mm.
Art. 02.020	H 120 mm.
Art. 02.021	H 130 mm.
Art. 02.022	H 160 mm.
Art. 02.023	H 190 mm.
Art. 02.024	H 250 mm.
Art. 02.024.01	H 110 mm.
Art. 02.024.02	H 125 mm.
Art. 02.024.03	H 175 mm.
Art. 02.024.04	H 200 mm.
Art. 02.024.05	H 300 mm.

≠ 30 X 4 mm.	
Art. 02.030.06	H 100 mm.
Art. 02.030.07	H 110 mm.
Art. 02.030.08	H 120 mm.
Art. 02.030.09	H 125 mm.
Art. 02.030.10	H 130 mm.
Art. 02.030.11	H 160 mm.
Art. 02.030.12	H 190 mm.
Art. 02.030.13	H 250 mm.

≠ 14 X 6 mm.	
Art. 02.036	H 100 mm.
Art. 02.037	H 120 mm.
Art. 02.038	H 130 mm.
Art. 02.039	H 160 mm.
Art. 02.040	H 190 mm.
Art. 02.041	H 250 mm.
Art. 02.041.01	H 80 mm.
Art. 02.041.02	H 90 mm.
Art. 02.041.03	H 105 mm.
Art. 02.041.04	H 110 mm.
Art. 02.041.05	H 115 mm.
Art. 02.041.06	H 125 mm.
Art. 02.041.07	H 128 mm.
Art. 02.041.08	H 150 mm.

≠ 16 X 8 mm.	
Art. 02.042	H 100 mm.
Art. 02.043	H 120 mm.
Art. 02.043.01	H 110 mm.
Art. 02.043.02	H 128 mm.
Art. 02.043.03	H 130 mm.
Art. 02.043.04	H 180 mm.

≠ 20 X 4 mm.	
Art. 02.025	H 100 mm.
Art. 02.026	H 120 mm.
Art. 02.027	H 130 mm.
Art. 02.028	H 160 mm.
Art. 02.029	H 190 mm.
Art. 02.030	H 250 mm.
Art. 02.030.01	H 110 mm.
Art. 02.030.02	H 125 mm.
Art. 02.030.03	H 175 mm.
Art. 02.030.04	H 200 mm.
Art. 02.030.05	H 300 mm.

≠ 12 X 6 mm.	
Art. 02.031	H 100 mm.
Art. 02.032	H 120 mm.
Art. 02.033	H 130 mm.
Art. 02.034	H 160 mm.
Art. 02.035	H 190 mm.
Art. 02.035.01	H 80 mm.
Art. 02.035.02	H 90 mm.
Art. 02.035.03	H 105 mm.
Art. 02.035.04	H 110 mm.
Art. 02.035.05	H 115 mm.
Art. 02.035.06	H 125 mm.
Art. 02.035.07	H 128 mm.
Art. 02.035.08	H 150 mm.
Art. 02.035.09	H 250 mm.

≠ 20 X 6 mm.	
Art. 02.041.09	H 80 mm.
Art. 02.041.10	H 90 mm.
Art. 02.041.11	H 100 mm.
Art. 02.041.12	H 105 mm.
Art. 02.041.13	H 110 mm.
Art. 02.041.14	H 115 mm.
Art. 02.041.15	H 120 mm.
Art. 02.041.16	H 125 mm.
Art. 02.041.17	H 128 mm.
Art. 02.041.18	H 130 mm.
Art. 02.041.19	H 150 mm.
Art. 02.041.20	H 160 mm.
Art. 02.041.21	H 190 mm.
Art. 02.041.22	H 250 mm.

≠ 16 X 6 mm.	
Art. 02.043.29	H 80 mm.
Art. 02.043.30	H 90 mm.
Art. 02.043.31	H 100 mm.
Art. 02.043.32	H 105 mm.
Art. 02.043.33	H 110 mm.
Art. 02.043.34	H 115 mm.
Art. 02.043.35	H 120 mm.
Art. 02.043.36	H 125 mm.
Art. 02.043.37	H 128 mm.
Art. 02.043.38	H 130 mm.
Art. 02.043.39	H 150 mm.
Art. 02.043.40	H 160 mm.
Art. 02.043.41	H 190 mm.
Art. 02.043.42	H 250 mm.



Cerchio aperto sezione in piatto
Open circle flat section

$\neq 12 \times 6$ mm.		$\neq 20 \times 6$ mm.	
Art. 02.043.05	H 100 mm.	Art. 02.043.15	H 100 mm.
Art. 02.043.06	H 110 mm.	Art. 02.043.16	H 110 mm.
Art. 02.043.07	H 120 mm.	Art. 02.043.17	H 120 mm.
Art. 02.043.08	H 130 mm.	Art. 02.043.18	H 130 mm.
Art. 02.043.09	H 150 mm.	Art. 02.043.19	H 150 mm.
$\neq 14 \times 6$ mm.		$\neq 16 \times 8$ mm.	
Art. 02.043.10	H 100 mm.	Art. 02.043.20	H 100 mm.
Art. 02.043.11	H 110 mm.	Art. 02.043.21	H 110 mm.
Art. 02.043.12	H 120 mm.	Art. 02.043.22	H 120 mm.
Art. 02.043.13	H 130 mm.	Art. 02.043.23	H 130 mm.
Art. 02.043.14	H 150 mm.	$\neq 16 \times 6$ mm.	
		Art. 02.043.43	H 100 mm.
		Art. 02.043.44	H 110 mm.
		Art. 02.043.45	H 120 mm.
		Art. 02.043.46	H 130 mm.
		Art. 02.043.47	H 150 mm.



Cerchio aperto sez. in quadro
Open circle square section

$\square 12 \times 12$ mm.	
Art. 02.043.24	H 100 mm.
Art. 02.043.25	H 110 mm.
Art. 02.043.26	H 120 mm.
Art. 02.043.27	H 130 mm.
Art. 02.043.28	H 180 mm.

Estremità battute e rastremate a caldo
Heat forged and tapered ends

H 100 mm	$\neq 12 \times 6$ mm
Art. 02.043.100	

H.200 X L.125 mm.
Art. 02.044 $\neq 12 \times 6$

H.160 X L.100 mm.
Art. 02.045 $\neq 16 \times 8$
Art. 02.045.01 $\neq 12 \times 6$
Art. 02.045.02 $\neq 14 \times 6$

H.140 X L.100 mm.
Art. 02.046 $\neq 16 \times 8$

H.190 X L.130 mm.
Art. 02.047 $\neq 20 \times 4$



H.160 X L.120 mm.
Art. 02.048 $\neq 16 \times 8$



Ovale Piatto Modello Scala Scala Model Flat Oval H.160 X L.100 mm.
Art. 02.048.01 $\neq 12 \times 6$
Art. 02.048.02 $\neq 14 \times 6$
Art. 02.048.03 $\neq 16 \times 6$



H.240 X L.170 mm.
Art. 02.049 $\square 14 \times 14$



H.160 X L.115 mm.
Art. 02.050 $\square 12 \times 12$



NEW



NEW



H.100 X L.100 mm.
Art. 02.050.50 ≙ 14 x 6

H.110 X L.110 mm.
Art. 02.050.51 ≙ 12 x 6

H.110 X L.110 mm.
Art. 02.050.55 ≙ 12 x 6

H.200 X L.200 mm.
Art. 02.051 □ 8 X 8
Art. 02.052 □ 10 X 10
Art. 02.053 □ 12 X 12

H.80 X L.80 mm.
Art. 02.050.54 ≙ 12 x 6

NEW



H.220 X L.220 mm.
Art. 02.050.56 ≙ 12 x 6

NEW

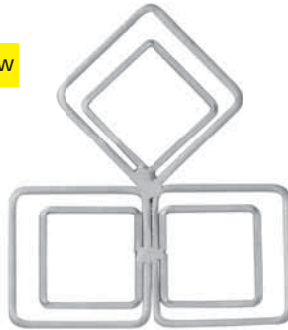

H.250 X L.220 mm.
Art. 02.050.60 ≙ 12 x 6



H.270 X L.190 mm.
Art. 02.054 □ 14 X 14



H.165 X L.120 mm.
Art. 02.055 □ 12 X 12



H.250 X L.175 mm.
Art. 02.056 □ 14 X 14



Mod. Scala / Scala Model
H.235 X L.125 mm.
Art. 02.057 ≙ 12 X 6
Art. 02.058 ≙ 14 X 6



H.250
Art. 02.059 ≙ 12 X 6
Art. 02.060 ≙ 14 X 6
Art. 02.061 ≙ 20 X 5



Mod. Scala / Scala Model
H.300 X L.110 mm.
Art. 02.062 ≙ 12 X 6
Art. 02.063 ≙ 14 X 6

Estremità battute e rastremate a caldo
Heat forged and tapered ends



H.50 X L.50 mm.
Art. 02.063.01 □ 4 X 4 - 6 Traf. / Elem.
Art. 02.063.02 □ 4 X 4 - 4 Traf. / Elem.



H.70 X L.70 mm.
Art. 02.063.03 □ 6 X 6 - 6 Traf. / Elem.
Art. 02.063.04 □ 6 X 6 - 4 Traf. / Elem.



H.70 X L.70 mm.
Art. 02.063.05 Ø 6 - 6 Traf. / Elem.

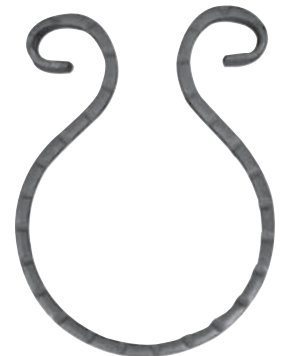

Mod. Scala / Scala Model
H.160 X L.110 mm.
Art. 02.064 ≙ 12 X 6
Art. 02.065 ≙ 14 X 6



Piatto Modello Scala
Flat Scala Model

Foro Ø 14 mm
Hole Ø 14 mm

Tondo Lavorato
Worked Round Bar

≠ 12 X 6 mm.
Art. 02.065.01 H 100 mm.
Art. 02.065.02 H 120 mm

≠ 12 X 6 mm.
Art. 02.065.07 H 100 mm.
Art. 02.065.08 H 120 mm

Ø 14 mm.
Art. 02.065.13 H 110 mm.
Art. 02.065.14 H 125 mm

Ø 14 mm.
Art. 02.065.15 H 100 mm.
Art. 02.065.16 H 110 mm.
Art. 02.065.17 H 120 mm.

≠ 14 X 6 mm.
Art. 02.065.03 H 100 mm.
Art. 02.065.04 H 120 mm.

≠ 14 X 6 mm.
Art. 02.065.09 H 100 mm.
Art. 02.065.10 H 120 mm.

≠ 16 X 6 mm.
Art. 02.065.05 H 100 mm.
Art. 02.065.06 H 120 mm.

≠ 16 X 6 mm.
Art. 02.065.11 H 100 mm.
Art. 02.065.12 H 120 mm.

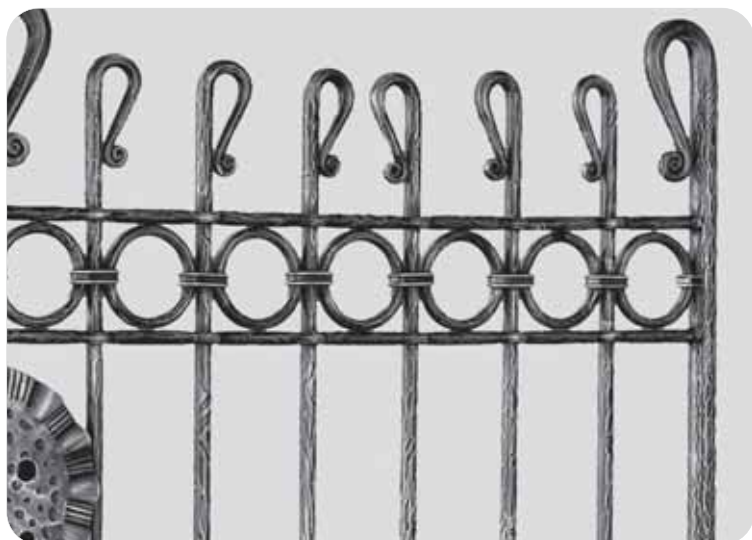



Piatto Modello Scala
Flat Scala Model



Piatto Modello Scala
Flat Scala Model



Martellato
Hammered

≠ 12 X 6 mm.

Art. 02.066	H 100 mm.
Art. 02.066.01	H 110 mm.
Art. 02.067	H 120 mm.
Art. 02.068	H 130 mm.
Art. 02.068.01	H 150 mm.

≠ 14 X 6 mm.

Art. 02.069	H 100 mm.
Art. 02.069.01	H 110 mm.
Art. 02.070	H 120 mm.
Art. 02.071	H 130 mm.
Art. 02.071.01	H 150 mm.

≠ 20 X 6 mm.

Art. 02.071.02	H 100 mm.
Art. 02.071.03	H 110 mm.
Art. 02.071.04	H 120 mm.
Art. 02.071.05	H 130 mm.
Art. 02.071.06	H 150 mm.

≠ 12 X 6 mm.

Art. 02.072	H 100 mm.
Art. 02.073	H 120 mm.
Art. 02.074	H 130 mm.
Art. 02.074.01	H 80 mm.
Art. 02.074.02	H 90 mm.
Art. 02.074.03	H 105 mm.
Art. 02.074.04	H 110 mm.
Art. 02.074.05	H 115 mm.
Art. 02.074.06	H 125 mm.
Art. 02.074.07	H 150 mm.
Art. 02.074.08	H 250 mm.

≠ 14 X 6 mm.

Art. 02.075	H 100 mm.
Art. 02.076	H 120 mm.
Art. 02.077	H 130 mm.
Art. 02.077.01	H 80 mm.
Art. 02.077.02	H 90 mm.
Art. 02.077.03	H 105 mm.
Art. 02.077.04	H 110 mm.
Art. 02.077.05	H 115 mm.
Art. 02.077.06	H 125 mm.
Art. 02.077.07	H 150 mm.
Art. 02.077.08	H 250 mm.

≠ 20 X 6 mm.

Art. 02.077.09	H 80 mm.
Art. 02.077.10	H 90 mm.
Art. 02.077.11	H 100 mm.
Art. 02.077.12	H 105 mm.
Art. 02.077.13	H 110 mm.
Art. 02.077.14	H 115 mm.
Art. 02.077.15	H 120 mm.
Art. 02.077.16	H 125 mm.
Art. 02.077.17	H 130 mm.
Art. 02.077.18	H 150 mm.
Art. 02.077.19	H 160 mm.
Art. 02.077.20	H 190 mm.
Art. 02.077.21	H 250 mm.

≠ 16 x 6 mm.

Art. 02.074.17	H 100 mm.
Art. 02.074.18	H 110 mm.
Art. 02.074.20	H 120 mm.

□ 12 X 12 mm.

Art. 02.077.22	H 100 mm.
Art. 02.077.23	H 110 mm.
Art. 02.077.24	H 120 mm.
Art. 02.077.25	H 180 mm.

Mart. a caldo / Hot hammered
□ 14 X 14 mm.

Art. 02.077.26	H 100 mm.
Art. 02.077.27	H 110 mm.
Art. 02.077.28	H 115 mm.
Art. 02.077.29	H 120 mm.
Art. 02.077.30	H 125 mm.
Art. 02.077.31	H 130 mm.
Art. 02.077.32	H 135 mm.
Art. 02.077.33	H 140 mm.
Art. 02.077.34	H 160 mm.
Art. 02.077.35	H 180 mm.
Art. 02.077.36	H 250 mm.

Mart. a caldo / Hot hammered
□ 16 X 16 mm.

Art. 02.077.37	H 100 mm.
Art. 02.077.38	H 110 mm.
Art. 02.077.39	H 120 mm.
Art. 02.077.40	H 135 mm.
Art. 02.077.41	H 140 mm.
Art. 02.077.42	H 180 mm.
Art. 02.077.43	H 250 mm.

Pigne a 4 Trafilati / 4 - Element Crowns



H.90 X L.35 mm.
Art. 02.078 □ 8 X 8



H.110 X L.45 mm.
Art. 02.079 □ 10 X 10



H.150 X L.65 mm.
Art. 02.080 □ 12 X 12



Liscio / Smooth
4 Trafilati / Elements
Art. 02.080.ES
H. 125 x L.57 mm □ 12 x 12



H.160 X L.70 mm.
Art. 02.081 □ 14 X 14



H.160 X L.70 mm.
Art. 02.082 □ 16 X 16

Art. 02.081.ES
H. 135 x L.60 mm □ 14 x 14
Art. 02.082.ES
H. 150 x L.70 mm □ 16 x 16



H.210 X L.90 mm.
Art. 02.083 □ 20 X 20



H.210 X L.110 mm.
Art. 02.084 □ 24 X 24
Martellato / Hammered
Art. 02.084.01 □ 24 X 24



H.240 X L.115 mm.
Art. 02.085 □ 30 X 30



4 Quadri da 6 mm
4 Six mm Squares



H.150 X L.50 mm.
Art. 02.089 □ 12 X 12



4 Tondini da 6 mm
4 Six mm Rounds

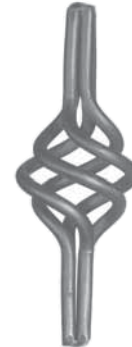

H.150 X L.50 mm.
Art. 02.090 Ø 12



4 Tondini da 6 mm
4 Six mm Rounds



H.150 X L.60 mm.
Art. 02.091 Ø 12



Art. 02.100 H.195 X L.50 mm. □ 12 X 12
Art. 02.100.01 H.200 X L.60 mm. □ 14 X 14
Art. 02.100.02 H.200 X L.65 mm. □ 16 X 16
Art. 02.100.03 H.195 X L.50 mm. Ø 12
A 9 trafilati / 9 - Element Crowns
Art. 02.100.04 H.195 X L.50 mm. □ 12 X 12



H.100 X L.100 mm.
Art. 02.130
≠ 14 X 6
□ 4 X 4



H.160 X L.105 mm.
Art. 02.140
≠ 14 X 6
□ 6 X 6



Pigne a 9 Trafilati / 9 - Element Crowns

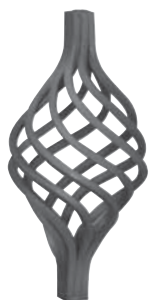

H.155 X L.75 mm.
Art. 02.086 □ 12 X 12

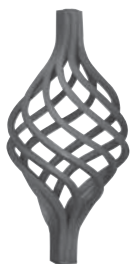

H.125 X L.65 mm.
Art. 02.086.01 □ 12 X 12



H.190 X L.105 mm.
Art. 02.087 □ 24 X 24

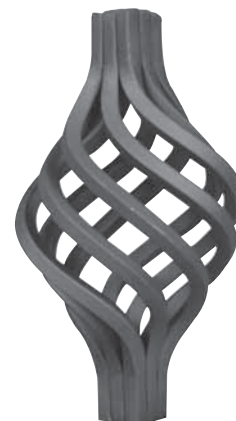

H.245 X L.130 mm.
Art. 02.088 □ 30 X 30



Liscio / Smooth
H. 190 x L.120 mm
Art. 02.200 □ 16 mm
Art. 02.200.01 □ 20 mm



Liscio / Smooth
H. 380 x L.120 mm
Art. 02.201 □ 16 mm



Liscio / Smooth
H. 235 x L.120 mm
Art. 02.202 □ 16 mm



Liscio / Smooth
H. 155 x L.135 mm
Art. 02.203 □ 16 mm
Art. 02.203.01 □ 20 mm



Liscio / Smooth
H. 470 x L.120 mm
Art. 02.204 □ 16 mm

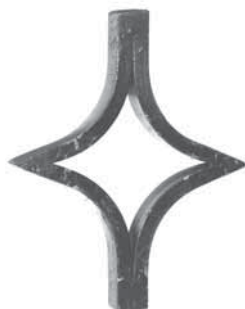

Liscio / Smooth
H. 185 x L.155 mm
Art. 02.205 □ 16 mm



Liscio / Smooth
H. 195 x L.165 mm
Art. 02.206 □ 16 mm



Liscio / Smooth
H. 240 x L.135 mm
Art. 02.207 □ 16 mm

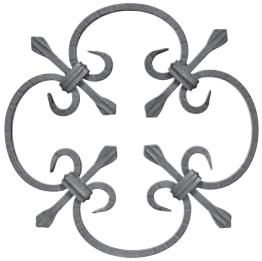

H.250 x L.250 mm
Modello Scala / Scala Model
Art. 03.001 □ 8 x 8
Liscio / Smooth
Art. 03.001.01 □ 8 x 8

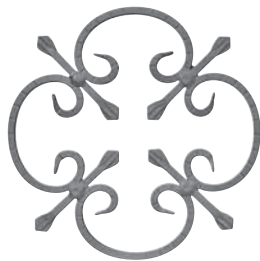

H.250 x L.250 mm
Modello Scala / Scala Model
Art. 03.002 □ 8 x 8
Liscio / Smooth
Art. 03.002.01 □ 8 x 8

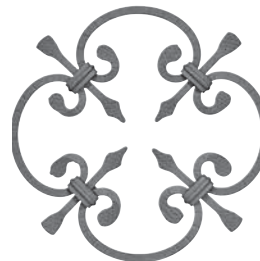

Mod. Scala / Scala Model
H.250 X L.250 mm.
Art. 03.003 □ 8 X 8



Mod. Scala / Scala Model
H.250 X L.250 mm.
Art. 03.004 □ 8 X 8



Mod. Scala / Scala Model
H.250 X L.250 mm.
Art. 03.005 ≧ 20 X 4

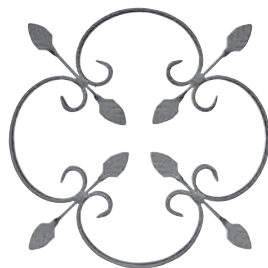

Mod. Scala / Scala Model
H.250 X L.250 mm.
Art. 03.006 ≧ 20 X 4

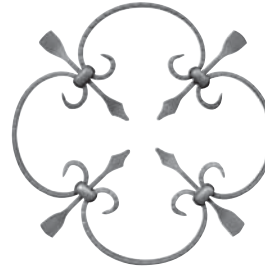

Mod. Scala / Scala Model
H.250 X L.250 mm.
Art. 03.007 ≧ 10 X 5



Mod. Scala / Scala Model
H.250 X L.250 mm.
Art. 03.008 ≧ 10 X 5

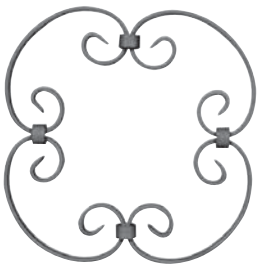

Liscio / Smooth
H.250 X L.250 mm.
Art. 03.009 ≧ 16 X 4

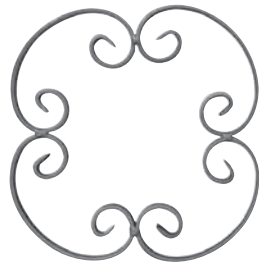

Liscio / Smooth
H.250 X L.250 mm.
Art. 03.010 ≧ 16 X 4

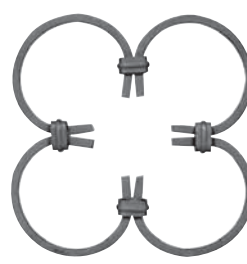

Liscio / Smooth
H.250 X L.250 mm.
Art. 03.011 □ 8 X 8



Liscio / Smooth
H.250 X L.250 mm.
Art. 03.012 □ 8 X 8



H.250 X L.250 mm.
Art. 03.013 □ 8 X 8



Mod. Scala / Scala Model
H.250 X L.250 mm.
Art. 03.014 □ 8 X 8

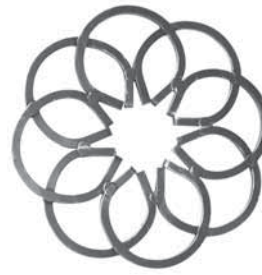

Liscio / Smooth
H.250 x L.250 mm
Art. 03.014.01 □ 8
Art. 03.014.02 Ø 8



Liscio / Smooth
H.250 x L.250 mm
Art. 03.014.03 ≡ 12 x 4



Liscio / Smooth
H.250 x L.250 mm
Art. 03.014.04 ≡ 12 x 4

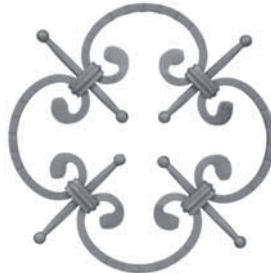

Mod. Scala / Scala Model
H.250 X L.250 mm.
Art. 03.015 □ 8 X 8

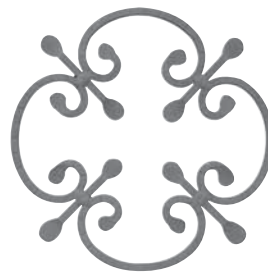

Mod. Scala / Scala Model
H.250 X L.250 mm.
Art. 03.016 □ 8 X 8

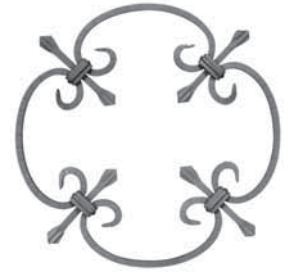

Mod. Scala / Scala Model
H.300 X L.300 mm.
Art. 03.017 □ 8 X 8

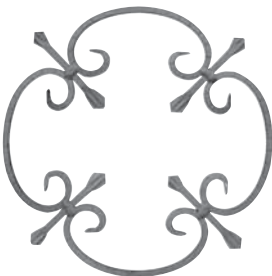

Mod. Scala / Scala Model
H.300 X L.300 mm.
Art. 03.018 □ 8 X 8

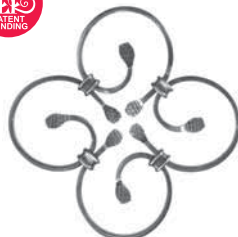

Liscio / Smooth
H.250 X L.250 mm.
Art. 03.018.01 ≡ 12 X 6

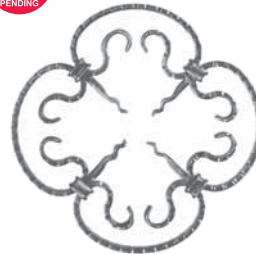

Mod. Scala / Scala Model
H.270 X L.270 mm.
Art. 03.018.03 ≡ 14 X 6



⊗ Tondo / Round
H.380 X L.380 mm.
Art. 03.018.04 Ø 12

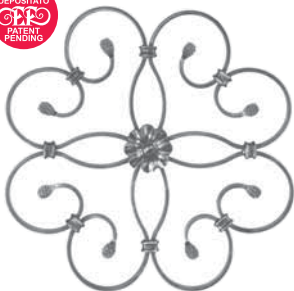

⊗ Liscio / Smooth
H.360 X L.360 mm.
Art. 03.018.05 ≡ 12 X 6
Art. 03.018.16 ≡ 14 X 6



Liscio / Smooth
H.370 X L.370 mm.
Art. 03.018.06 ≡ 12 X 6
Art. 03.018.17 ≡ 14 X 6



🌀 fiori da entrambi i lati / flowers on both sides



🌀 Mod. Scala / Scala Model
H.445 X L.445 mm.
Art. 03.018.07 ≙ 14 X 6
Art. 03.018.18 ≙ 16 X 6

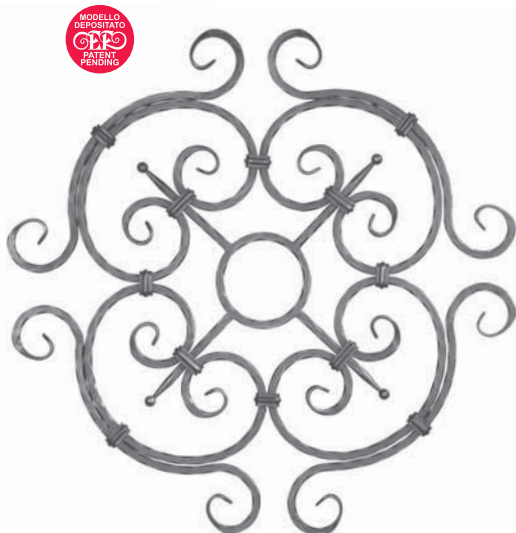

🌀 Martellato / Hammered
H.710 X L.710 mm.
Art. 03.018.08 □ 12 X 12



🌀 Modello Scala / Scala Model
H.760 x L.760 mm.
Art. 03.018.09 ≙ 14 x 6
Art. 03.018.19 ≙ 16 x 6



🌀 Martellato / Hammered
H.780 X L.780 mm.
Art. 03.018.10 □ 12 X 12
Art. 03.018.11 □ 14 X 14

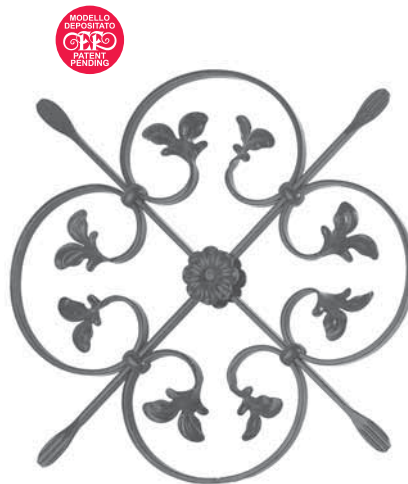

🌀 Liscio / Smooth
H.545 X L.545 mm.
Art. 03.018.12 ≙ 12 X 6

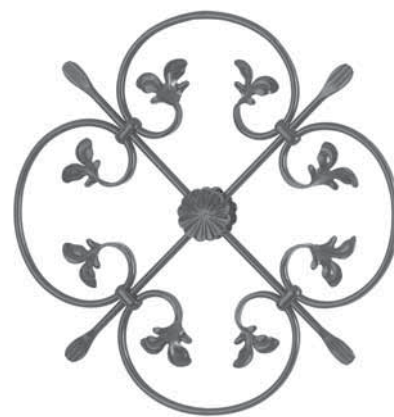

🌀 Liscio / Smooth
H.530 X L.530 mm.
Art. 03.018.13 Ø 10
Art. 03.018.20 Ø 12



🌀 Liscio / Smooth
H.545 X L.545 mm.
Art. 03.018.14
≙ 12 X 6
Ø 10



Liscio / Smooth
H.250 X L.250 mm.
Art. 03.018.15 Ø 8

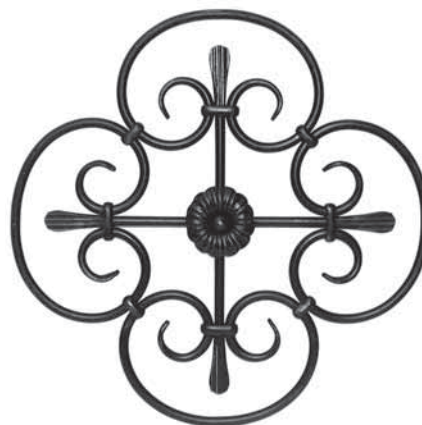

🌀 Liscio / Smooth
H.565 x L.565 mm
Art. 03.018.21 Ø 14 mm

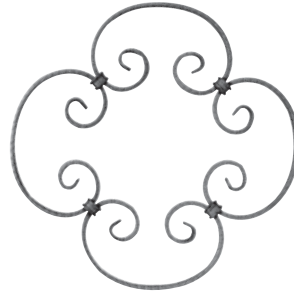
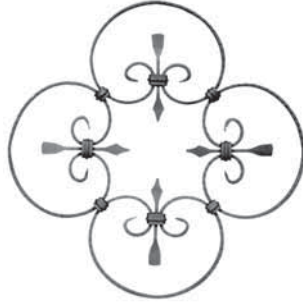
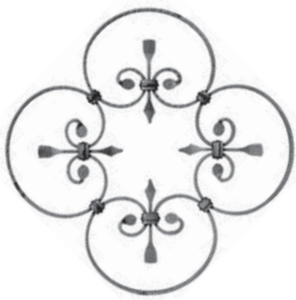
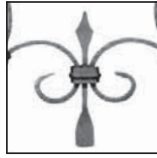

Mod. Scala / Scala Model
H.380 X L.380 mm.
Art. 03.019 ≙ 10 X 5

Mod. Scala / Scala Model
H.380 X L.380 mm.
Art. 03.020 ≙ 10 X 5

Mod. Scala / Scala Model
H.370 X L.370 mm.
Art. 03.021 ≙ 12 X 6

Rigato / Fluted
H.300 X L.300 mm.
Art. 03.022 ≙ 12 X 6

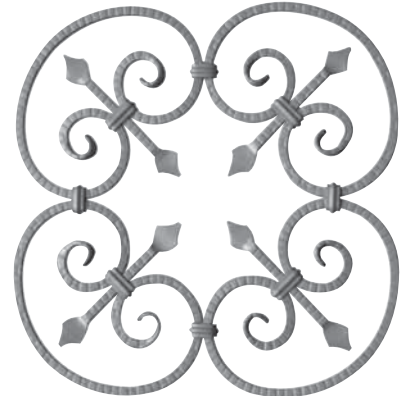
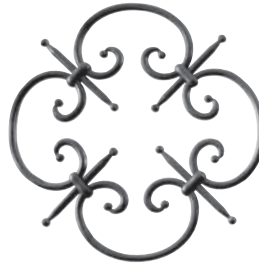

Rigato / Fluted
H.140 X L.205 mm.
Art. 03.023 ≙ 12 X 6

Mod. Scala / Scala Model
H.155 X L.155 mm.
Art. 03.024 □ 6 X 6

Liscio / Smooth
H.330 X L.330 mm.
Art. 03.024.01 Ø 10

Mod. Mattone / Brick Model
H.590 X L.590 mm.
Art. 03.025 □ 12 X 12
Art. 03.025.02 □ 14 X 14

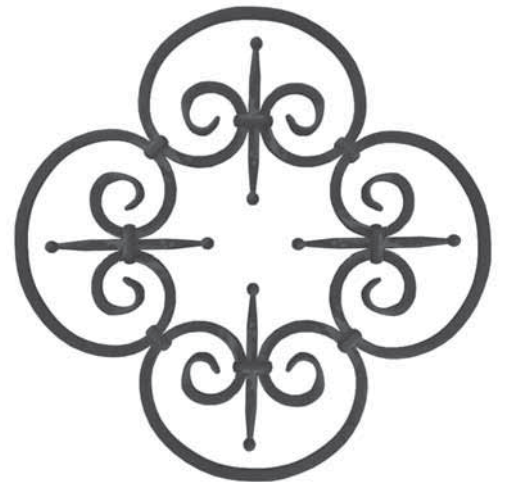
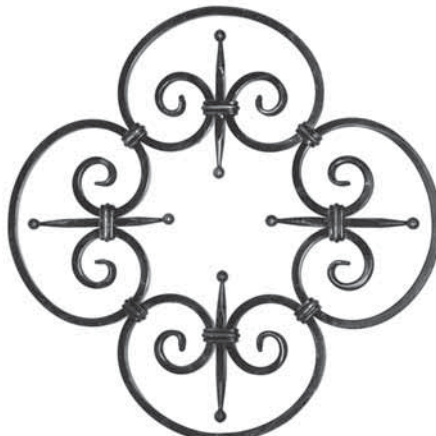
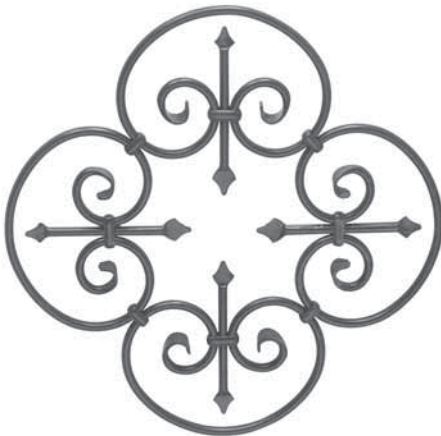

Liscio / Smooth
H.580 X L.580 mm.
Art. 03.025.01 Ø 12
Art. 03.025.03 Ø 14

Liscio / Smooth
H.580 x L.580 mm
Art. 03.025.04 □ 12 mm ;
Art. 03.025.05 □ 14 mm

Liscio / Smooth
H.625 x L. 625
Art. 03.025.10 □ 14x14 mm

Tutte le parti di questo catalogo - foto comprese - sono di proprietà Euro-Fer. La riproduzione, anche parziale, è vietata in ogni forma e con ogni mezzo. / Every part of this catalogue - photos included - is Euro-Fer's property. All forms of copying are strictly prohibited.

 fiori da entrambi i lati / flowers on both sides

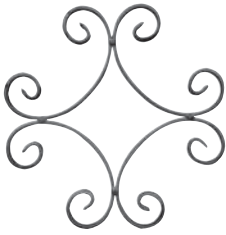

Liscio / Smooth
H.240 X L.240 mm.
Art. 03.026 \approx 16 X 4

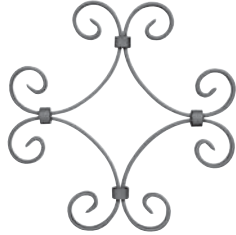

Liscio / Smooth
H.240 X L.240 mm.
Art. 03.027 \approx 16 X 4

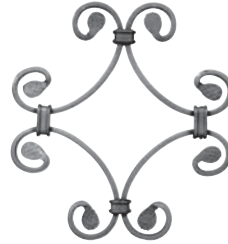

Liscio / Smooth
H.240 X L.240 mm.
Art. 03.028 \approx 12 X 6

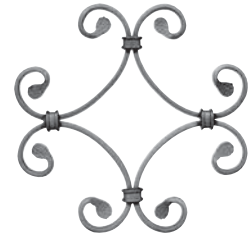

Liscio / Smooth
H.240 X L.240 mm.
Art. 03.029 \approx 12 X 6

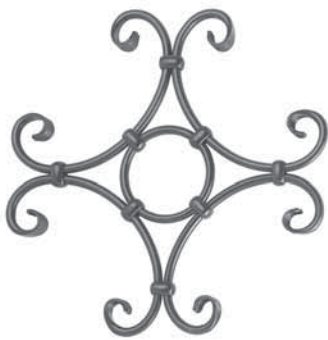

Liscio / Smooth
H.360 X L.360 mm.
Art. 03.029.01 \varnothing 10
Art. 03.029.03 \varnothing 12
Art. 03.029.04 \varnothing 14



 Liscio / Smooth
H.360 X L.360 mm.
Art. 03.029.02 \varnothing 10
Art. 03.029.05 \varnothing 12
Art. 03.029.06 \varnothing 14



Liscio / Smooth
H.250 X L.250 mm.
Art. 03.030 \approx 16 X 4

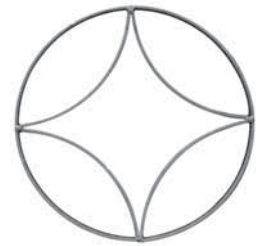

Liscio / Smooth
H.250 X L.250 mm.
Art. 03.031 \approx 16 X 4



Mod. Scala / Scala Model
H.270 X L.270 mm.
Art. 03.031.01 \approx 12 X 6
Art. 03.031.07 \approx 14 X 6



Liscio / Smooth
H.220 X L.220 mm.
Art. 03.031.02 \approx 12 X 6
Art. 03.031.08 \approx 14 X 6

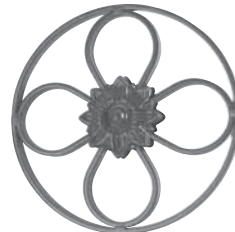

 Liscio / Smooth
H.250 X L.250 mm.
Art. 03.031.03 \approx 12 X 6
Art. 03.031.09 \approx 14 X 6



 Liscio / Smooth
H.250 X L.250 mm.
Art. 03.031.04 \approx 12 X 6



 Liscio / Smooth
H.250 X L.250 mm.
Art. 03.031.05 \varnothing 10



 Liscio / Smooth
H.250 X L.250 mm.
Art. 03.031.06 \varnothing 10



Liscio / Smooth
H.250 X L.250 mm.
Art. 03.032 \approx 16 X 4

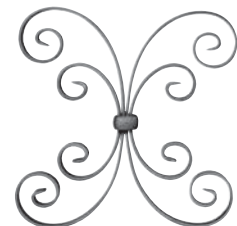

Liscio / Smooth
H.250 X L.250 mm.
Art. 03.033 \approx 16 X 4

🌀 fiori da entrambi i lati / flowers on both sides

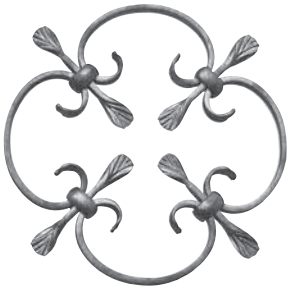

Liscio / Smooth
H.350 X L.350 mm.
Art. 03.033.01 ≡ 12 X 6
H.250 X L.250 mm.
Art. 03.033.02 ≡ 12 X 6



Liscio / Smooth
H.250 X L.250 mm.
Art. 03.034 ≡ 12 X 6



Liscio / Smooth
H.260 X L.260 mm.
Art. 03.034.01 ≡ 12 X 6

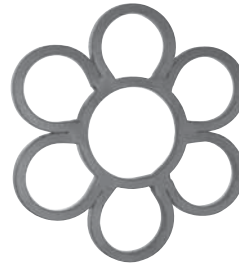

Liscio / Smooth
H.300 X L.300 mm.
Art. 03.034.10 □ 12 X 12

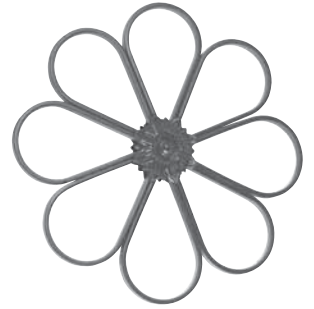

🌀 Liscio / Smooth
H.380 X L.380 mm.
Art. 03.034.12 ≡ 12 X 6



Liscio / Smooth
H.530 X L.530 mm.
Art. 03.034.21 ≡ 12 X 6



🌀 Liscio / Smooth
H.470 X L.470 mm.
Art. 03.034.22 Ø 10
Art. 03.034.29 Ø 12
Art. 03.034.30 Ø 14
Art. 03.034.31 Ø 16



🌀 Martellato / Hammered
H.520 X L.420 mm.
Art. 03.034.23 □ 12 X 12
Art. 03.034.32 □ 14 X 14
Liscio / Smooth
H.520 x L.420 mm
Art. 03.034.41 □ 12 X 12
Art. 03.034.42 Ø 12
Art. 03.034.43 Ø 14

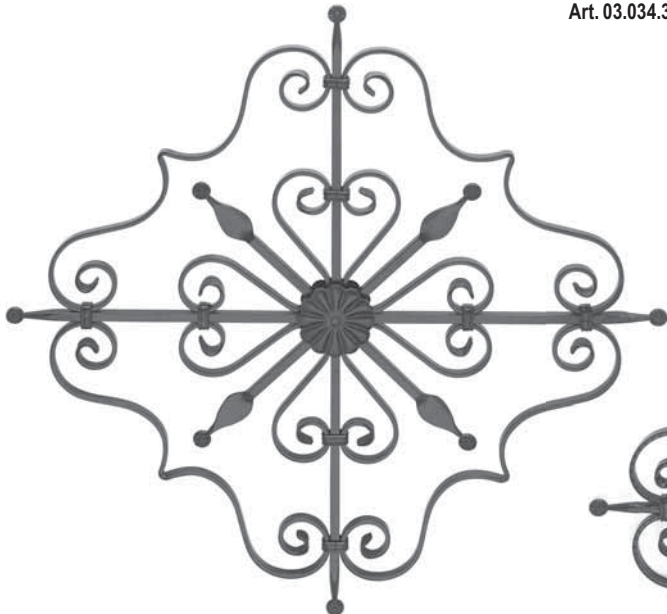

🌀 Liscio / Smooth
H.830 X L.830 mm.
Art. 03.034.24
≡ 12 X 6
□ 12 X 12
Art. 03.034.33
≡ 14 X 6
□ 14 X 14

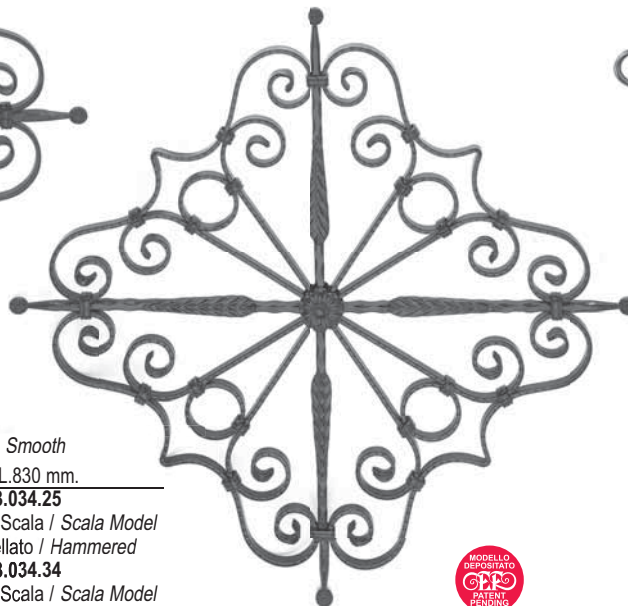

🌀 Liscio / Smooth
H.830 X L.830 mm.
Art. 03.034.25
≡ 12 X 6 Mod. Scala / Scala Model
□ 12 X 12 Martellato / Hammered
Art. 03.034.34
≡ 14 X 6 Mod. Scala / Scala Model
□ 14 X 14 Martellato / Hammered



Liscio / Smooth
H.500 X L.500 mm.
Art. 03.034.26 Ø 12
Art. 03.034.27 Ø 14
Art. 03.034.28 Ø 16



Tutte le parti di questo catalogo - foto comprese - sono di proprietà Euro-Fer. La riproduzione, anche parziale, è vietata in ogni forma e con ogni mezzo. / Every part of this catalogue - photos included - is Euro-Fer's property. All forms of copying are strictly prohibited.

🌀 fiori da entrambi i lati / flowers on both sides

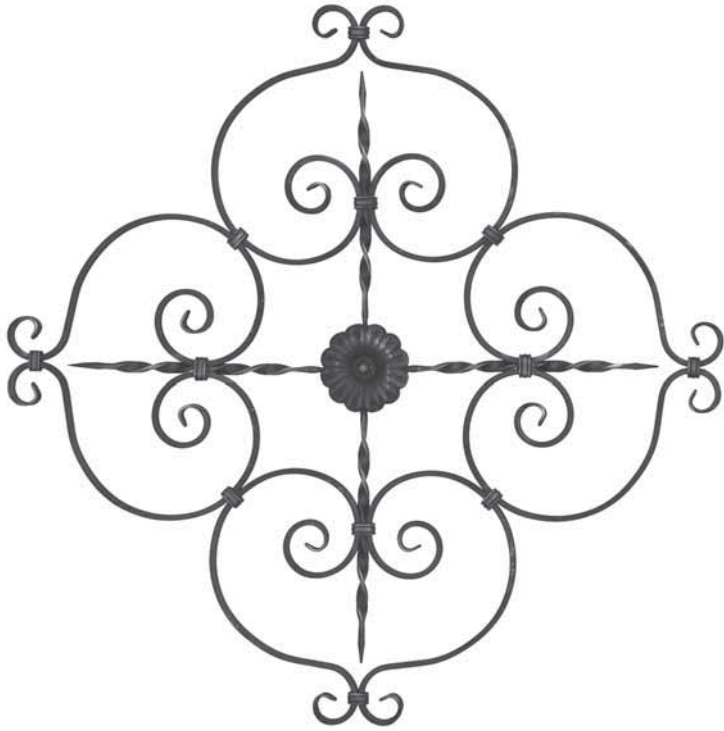

🌀 Liscio / Smooth
H.970 x L.970 mm
Art. 03.034.35 ≙ 16 x 8

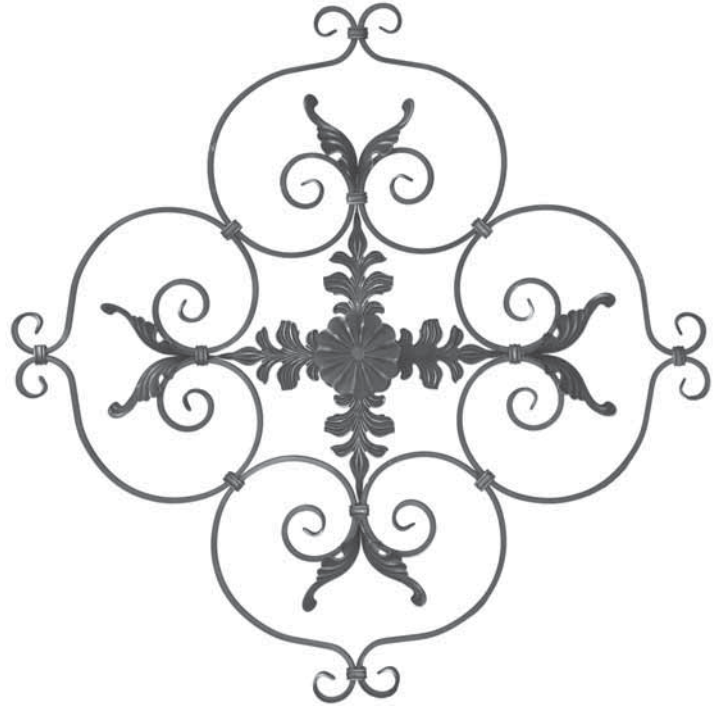

🌀 Liscio / Smooth
H.970 x L.970 mm
Art. 03.034.36 ≙ 16 x 8



Liscio / Smooth
L.200 x H.200 mm
Art. 03.034.38 ≙ 12 x 6

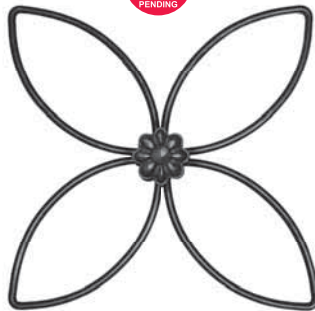

🌀 Liscio / Smooth
L.315 x H.315 mm
Art. 03.034.39 Ø 8



🌀 Martellato / Hammered
H.950 x L.430 mm
Art. 03.034.40 □ 12
Fiori su ambo i lati
Flowers on both sides



Art. 03.034.50
Art. 03.034.51

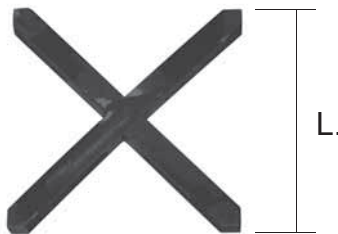

Liscio / Smooth
Art. 03.034.60 □ 12 L.100 x H.100 mm
Art. 03.034.61 □ 12 L.110 x H.110 mm
Art. 03.034.62 □ 12 L.125 x H.125 mm
Art. 03.034.63 □ 12 L.108 x H.108 mm



Modello Scala / Scala Model
H.155 X L.180 mm.
Art. 03.035 ≙ 10 X 5



Modello Scala / Scala Model
H.180 X L.130 mm.
Art. 03.035.01 ≙ 10 X 5



Modello Scala / Scala Model
H.155 X L.180 mm.
Art. 03.036 ≙ 10 X 5

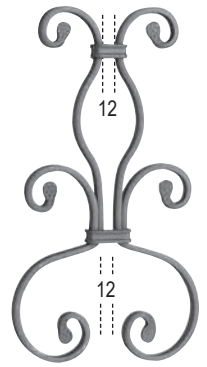

H.350 X L.190 mm.
Art. 03.036.01 ≙ 12 X 6



H.110 X L.125 mm.
Art. 03.036.02 ∅ 8



H.125 X L.115 mm.
Art. 03.037 ≙ 12 X 6
Art. 03.038 □ 8 X 8

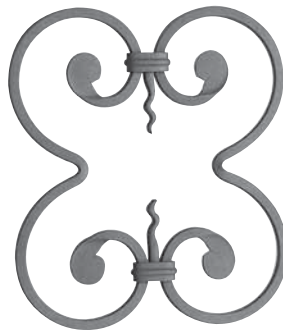

H.240 X L.210 mm.
Art. 03.038.01 □ 8 X 8



H.215 X L.155 mm.
Art. 03.039 ≙ 12 X 6

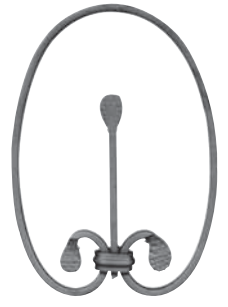

H.215 X L.155 mm.
Art. 03.040 ≙ 12 X 6



H.215 X L.165 mm.
Art. 03.041 ≙ 12 X 6



H.380 X L.185 mm.
Art. 03.042 ≙ 12 X 6

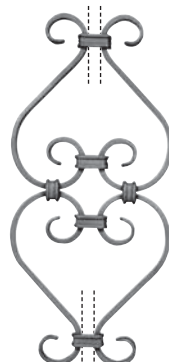

H.360 X L.165 mm.
Art. 03.043 ≙ 12 X 6



H.380 X L.230 mm.
Art. 03.044 ≙ 12 X 6

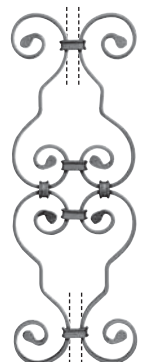

H.480 X L.170 mm.
Art. 03.045 ≙ 12 X 6



H.440 X L.225 mm.
Art. 03.046 ≙ 12 X 6

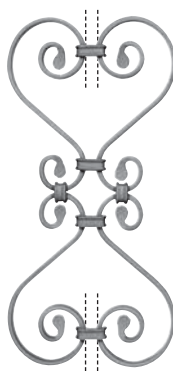

H.410 X L.200 mm.
Art. 03.047 ≙ 12 X 6



H.450 X L.205 mm.
Art. 03.048 ≙ 12 X 6



H.330 X L.180 mm.
Art. 03.049 ≙ 12 X 6

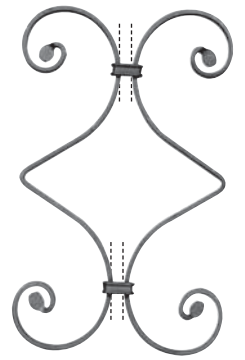

H.385 X L.230 mm.
Art. 03.050 ≙ 12 X 6

Tutte le parti di questo catalogo - foto comprese - sono di proprietà Euro-Fer. La riproduzione, anche parziale, è vietata in ogni forma e con ogni mezzo. / Every part of this catalogue - photos included - is Euro-Fer's property. All forms of copying are strictly prohibited.

🌀 fiori da entrambi i lati / flowers on both sides

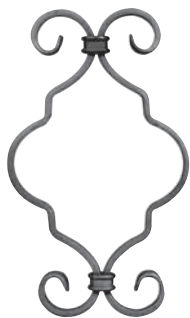

H.250 X L.160 mm.
Art. 03.051 ≙ 12 X 6



H.185 X L.200 mm.
Art. 03.051.01 ≙ 12 X 6
Art. 03.051.06 ≙ 14 X 6

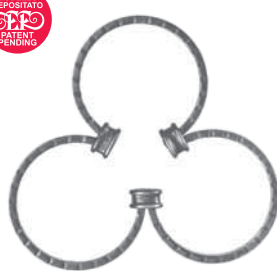

H.185 X L.200 mm.
Art. 03.051.02 ≙ 12 X 6
Art. 03.051.07 ≙ 14 X 6
Modello Scala / Scala Model



H.380 X L.135 mm.
Art. 03.051.03 ≙ 12 X 6



H.300 X L.115 mm.
Art. 03.051.04 ≙ 12 X 6
Art. 03.051.05 ≙ 14 X 6
Modello Scala / Scala Model



Liscio / Smooth
H.440 x L.160 mm
Art. 03.051.08 ≙ 14 x 6 mm
Art. 03.051.09 ≙ 16 x 6 mm



Liscio / Smooth
H.420 x L.180 mm
Art. 03.051.10 ≠ 12 x 6
Art. 03.051.11 ≠ 14 x 6

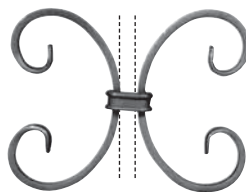

H.135 X L.165 mm.
Art. 03.052 ≙ 12 X 6

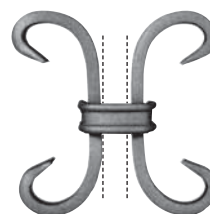

H.95 X L.95 mm.
Art. 03.053 ≙ 12 X 6

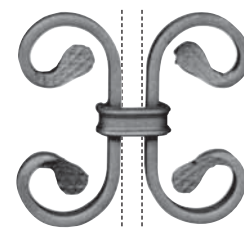

H.100 X L.110 mm.
Art. 03.054 ≙ 12 X 6



Liscio / Smooth
H.200 X L.190 mm.
Art. 03.055 Ø 10



🌀 Liscio / Smooth
H.100 X L.210 mm.
Art. 03.056 ≙ 12 X 6



Liscio / Smooth
H.100 X L.265 mm.
Art. 03.057 Ø 10



Liscio / Smooth
H.85 X L.230 mm.
Art. 03.058 ≙ 12 X 6



Liscio / Smooth
H.250 X L.170 mm.
Art. 03.059 □ 14 X 14



Liscio / Smooth
H.190 mm.
Art. 03.060 ≙ 12 X 6



Liscio / Smooth
H.290 X L.100 mm.
Art. 03.061 ≙ 12 X 6



Liscio / Smooth
H.125 mm.
Art. 03.062 □ 8 X 8



Liscio / Smooth
H.340 mm.
Art. 03.063 Ø 12
Sinistro - Left



Liscio / Smooth
H.340 mm.
Art. 03.064 Ø 12
Destro - Right

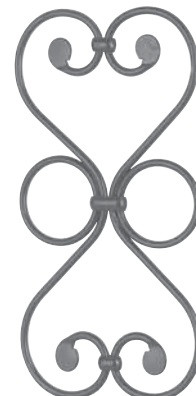

Liscio / Smooth
H.390 X L.200 mm.
Art. 03.065 Ø 8



Liscio / Smooth
H.370 X L.240 mm.
Art. 03.066 Ø 10



NEW
Liscio / Smooth
H.465 x L.300 mm
Art. 03.066.01 Ø 12

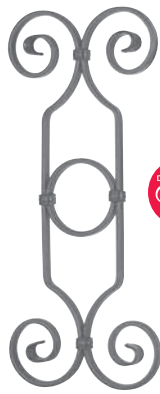

Liscio / Smooth
H.470 X L.210 mm.
Art. 03.067 ≙ 12 X 6
Art. 03.067.01 ≙ 14 X 6

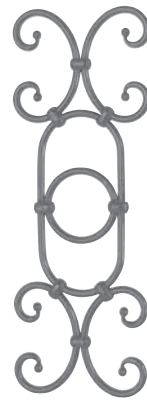

Liscio / Smooth
H.495 X L.180 mm.
Art. 03.068 Ø 10

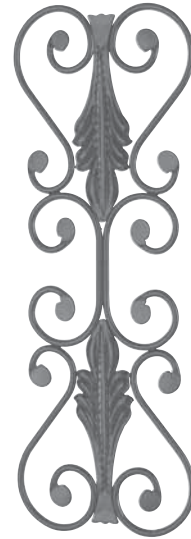

Liscio / Smooth
H.620 X L.235 mm.
Art. 03.069 Ø 8



Liscio / Smooth
H.460 X L.185 mm.
Art. 03.070 ≙ 12 X 6
Art. 03.070.01 ≙ 14 X 6

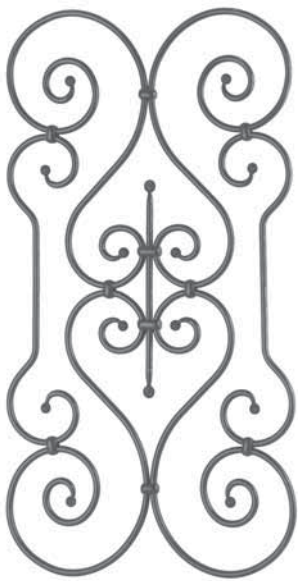

Liscio / Smooth
H.840 X L.440 mm.
Art. 03.071 Ø 10
Art. 03.071.01 Ø 12



Liscio / Smooth
H.400 X L.125 mm
Art. 03.080 □ 12 X 12

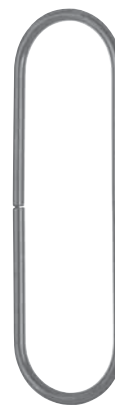

Liscio / Smooth
H.400 X L.125 mm.
Art. 03.081 Ø 12

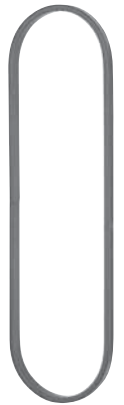

Liscio / Smooth
H.400 X L.115 mm.
Art. 03.082 ≙ 12 X 6

OVALI NON SALDATI / NOT WELDED OVALS

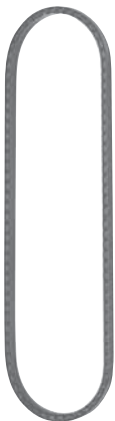

Mod. Scala / Scala Model
H.400 X L.115 mm.
Art. 03.083 ≙ 12 X 6



Liscio / Smooth
H.400 X L.125 mm
Art. 03.084 □ 12 X 12



Liscio / Smooth
H.400 X L.125 mm.
Art. 03.085 Ø 12



Liscio / Smooth
H.400 X L.115 mm.
Art. 03.086 ≙ 12 X 6



Mod. Scala / Scala Model
H.400 X L.115 mm.
Art. 03.087 ≙ 12 X 6



Liscio / Smooth
Art. 03.088 □ 14 H.710 x L.126 mm
Art. 03.088.01 □ 14 H.590 x L.126 mm
Art. 03.088.02 □ 14 H.540 x L.126 mm
Art. 03.088.03 □ 14 H.410 x L.126 mm

Tutte le parti di questo catalogo - foto comprese - sono di proprietà Euro-Fer. La riproduzione, anche parziale, è vietata in ogni forma e con ogni mezzo. / Every part of this catalogue - photos included - is Euro-Fer's property. All forms of copying are strictly prohibited.

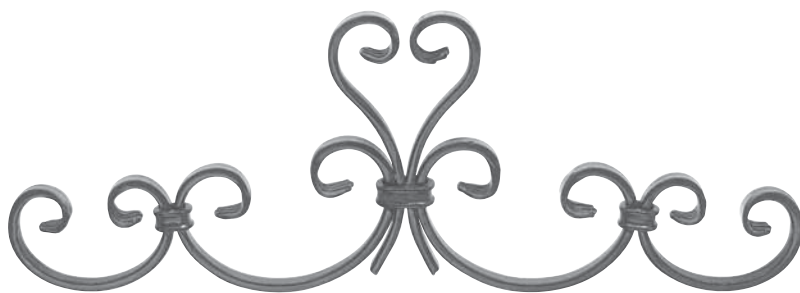

Liscio / Smooth
H.175 X L.500 mm.
Art. 03.090 \neq 12 X 6



Liscio / Smooth
H.210 X L.530 mm.
Art. 03.091 \neq 12
Art. 03.091.01 \neq 14



Liscio / Smooth
H.260 X L.885 mm.
Art. 03.092 \neq 12



Liscio / Smooth
H.300 X L.835 mm.
Art. 03.093 \neq 20 X 5



Liscio / Smooth
H.235 X L.580 mm.
Art. 03.094 \neq 10



Liscio / Smooth
H.235 X L.860 mm.
Art. 03.095 \neq 10



Liscio / Smooth
H.330 X L.1000 mm.
Art. 03.096 □ 12
Art. 03.096.01 □ 14
Art. 03.096.02 □ 16



Liscio / Smooth
L.1000 x H.110 mm
Art. 03.096.50 Ø 10
Con fiori su ambo i lati /
Flowers on both sides



Liscio / Smooth
L.1000 x H.110 mm
Art. 03.096.51 □ 10
Con fiori su ambo i lati /
Flowers on both sides



Attorcigliato / Twisted
L.1000 x H.110 mm
Art. 03.096.52 □ 10
Con fiori su ambo i lati /
Flowers on both sides



Modello Scala / Scala Model
L.1000 x H.110 mm
Art. 03.096.53 ≙ 12 x 6
Con fiori su ambo i lati /
Flowers on both sides



Liscio / Smooth
L.1230 x H.350 mm
Art. 03.097 ≙ 30 x 10

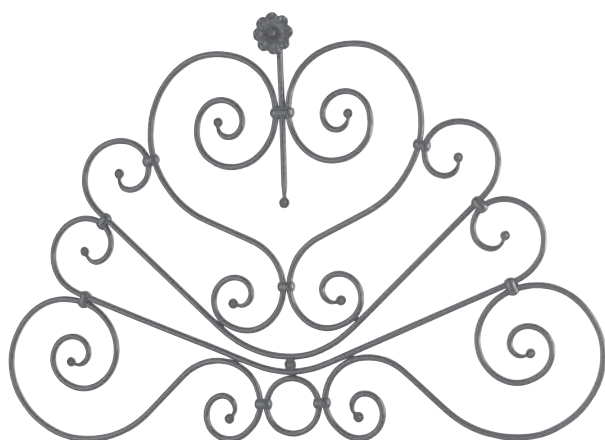

Liscio / Smooth
H.630 X L.930 mm.
Art. 03.100 Ø 10
Art. 03.100.01 Ø 12



Liscio / Smooth
H.900 X L.1300 mm.
Art. 03.101 Ø 12



Liscio / Smooth
H.900 X L.650 mm.
Art. 03.102 \varnothing 12
Sinistro - Left



Liscio / Smooth
H.900 X L.650 mm.
Art. 03.103 \varnothing 12
Destro - Right

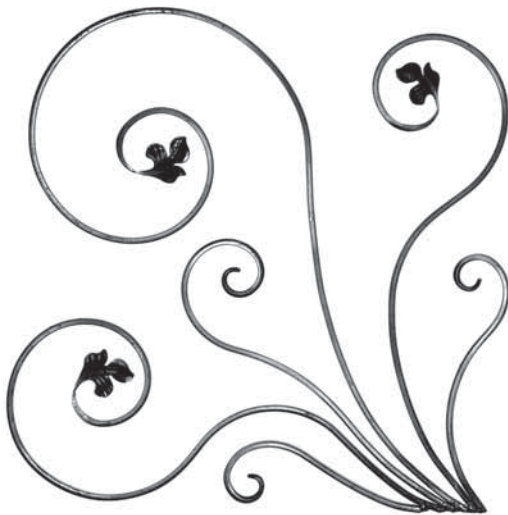

Liscio / Smooth
H.600 x L.600 mm
Art. 03.104 \varnothing 16 x 8
Sinistro / Left

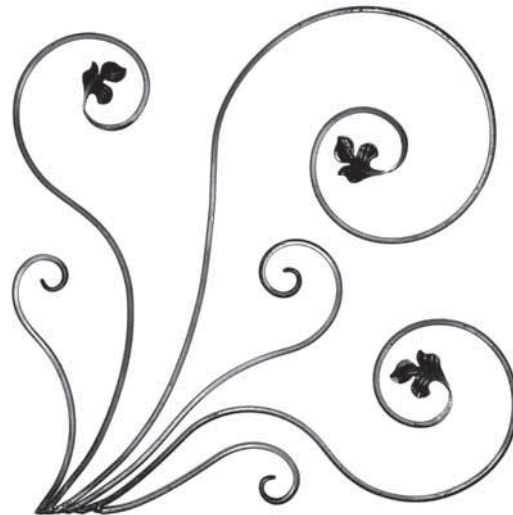

Liscio / Smooth
H.600 x L.600 mm
Art. 03.105 \varnothing 16 x 8
Destro / Right

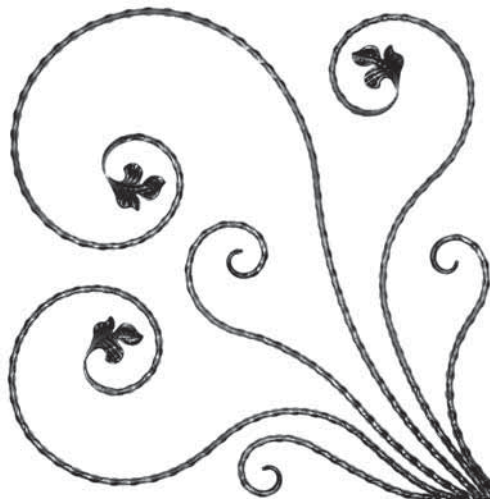

Martellato / Hammered
H.600 x L.600 mm
Art. 03.106 \varnothing 16 x 8
Sinistro / Left



Martellato / Hammered
H.600 x L.600 mm
Art. 03.107 \varnothing 16 x 8
Destro / Right



Art. 03.400
Liscio / Smooth
H.296 x L.296 mm ca.
□ 12 mm

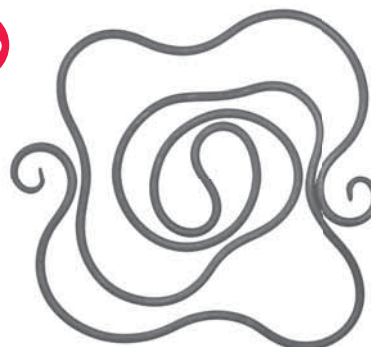

Art. 03.600
Martellato / Hammered
H.400 x L.400 mm ca.
Ø 12 mm

Art. 03.602
Liscio / Smooth
H.400 x L.400 mm ca.
Ø 10 mm

Art. 03.601
Modello Corteccia / Bark Model
H.400 x L.400 mm ca.
Ø 12 mm

Art. 03.610
Liscio / Smooth
H. 400 x L.400 mm c.a.
□ 10 mm



Martellato / Hammered
H.85 x L.295 mm
Art. 03.645 ≙ 12 x 6
Art. 03.645.01 ≙ 16 x 8 **NEW**

Liscio / Smooth
H.85 x L.295 mm **NEW**
Art. 03.646 ≙ 12 x 6
Art. 03.646.01 ≙ 16 x 8



Martellato / Hammered
H.270 x L.245 mm
Art. 03.650 ≙ 12 x 6

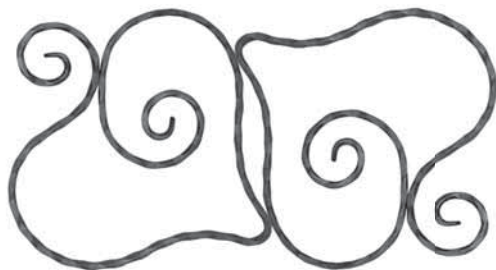

Martellato / Hammered
H.235 x L.390 mm
Art. 03.651. ≙ 12 x 6

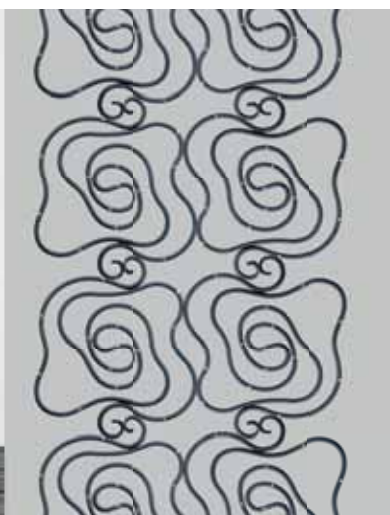

🌀 fiori da entrambi i lati / flowers on both sides

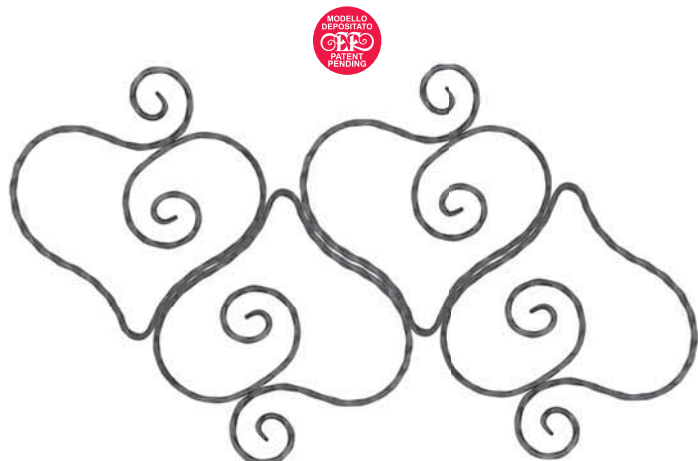

Martellato / *Hammered*
H.410 x L.620 mm
Art. 03.652. ≙ 12 x 6

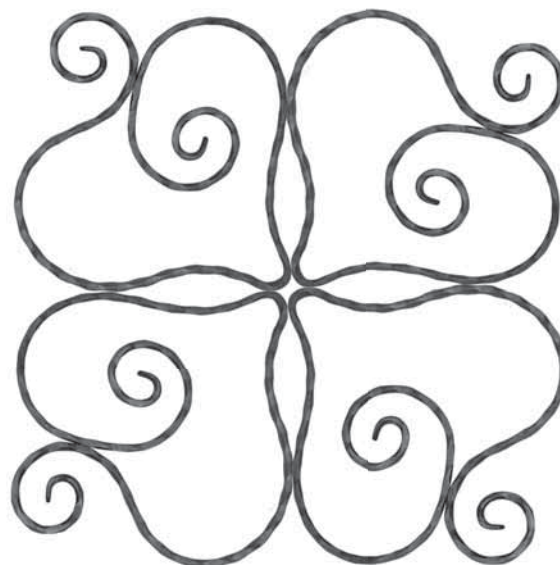

Martellato / *Hammered*
H.430 x L.430 mm
Art. 03.655. ≙ 12 x 6

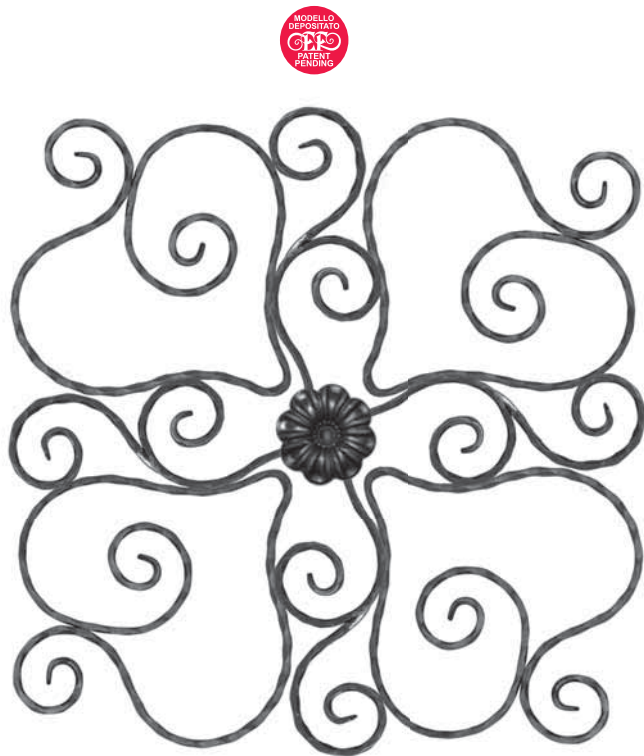

🌀 Martellato / *Hammered*
H.510 x L.510 mm
Art. 03.657 ≙ 12 x 6



🌀 fiori da entrambi i lati / flowers on both sides

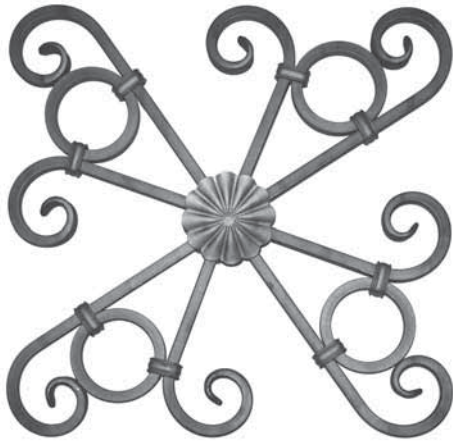

🌀 Liscio / Smooth
H.460 x L.460 mm
Art. 03.700 □ 12 mm



Liscio / Smooth
H.420 x L.420 mm
Art. 03.701 Ø 12 mm

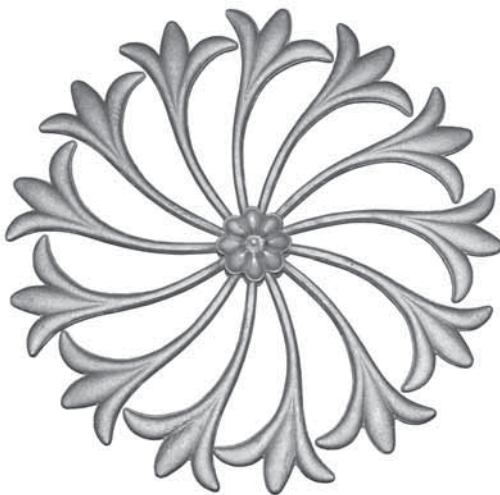

🌀 Liscio / Smooth
H.400 x L.400 mm
Art. 03.702
spessore / thickness 10 mm



Liscio / Smooth
H.460 x L.460 mm
Art. 03.703 Ø 12 mm

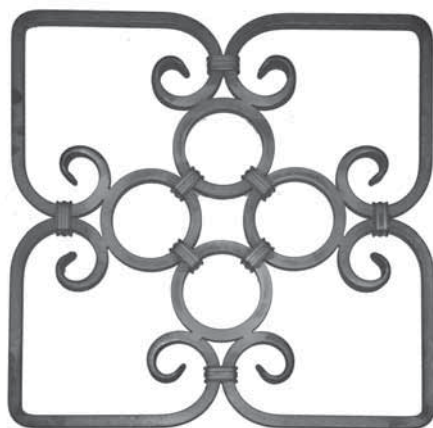

Liscio / Smooth
H.415 x L.415 mm
Art. 03.704 □ 12 mm

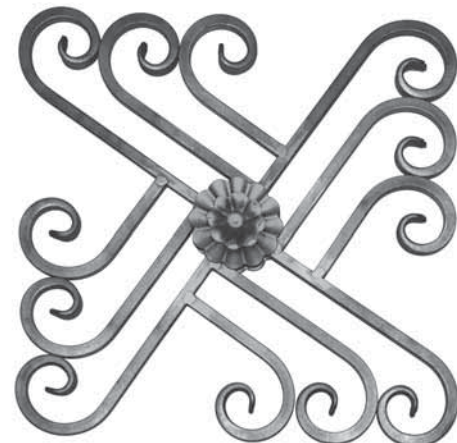

🌀 Liscio / Smooth
H.460 x L.460 mm
Art. 03.705 □ 12 mm

Tutte le parti di questo catalogo - foto comprese - sono di proprietà Euro-Fer. La riproduzione, anche parziale, è vietata in ogni forma e con ogni mezzo. / Every part of this catalogue - photos included - is Euro-Fer's property. All forms of copying are strictly prohibited.

 fiori da entrambi i lati / flowers on both sides

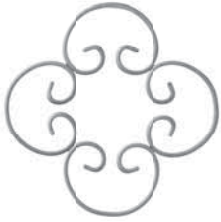

Liscio / Smooth
H.215 x L.215 mm
Art. 03.706 \neq 16 x 4



Liscio / Smooth
H.200 x L.200 mm
Art. 03.707 \varnothing 12



 Liscio / Smooth
H.260 x L.260 mm
Art. 03.708 \neq 12 x 6



Liscio / Smooth
H.250 x L.250 mm
Art. 03.709 \varnothing 12

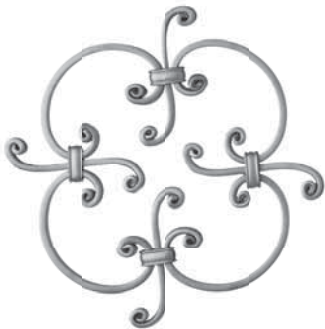

Liscio / Smooth
H.250 x L.250 mm
Art. 03.710 \neq 14 x 6

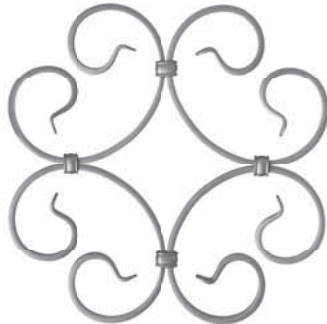

Liscio / Smooth
H.290 x L.290 mm
Art. 03.711 \neq 12 x 6

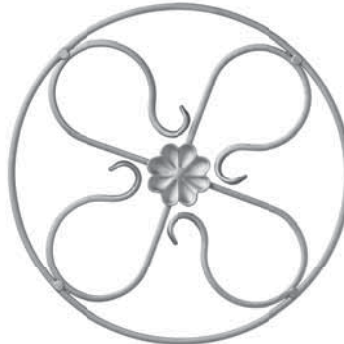

 Liscio / Smooth
H.300 x L.300 mm
Art. 03.712 \neq 12 x 6

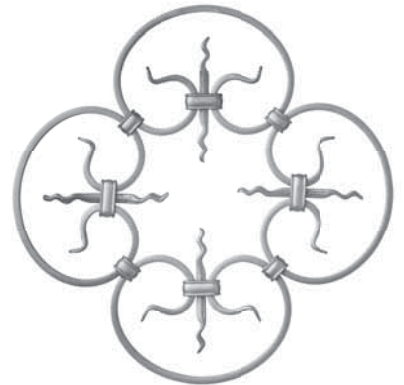

Liscio / Smooth
H.330 x L.330 mm
Art. 03.713 \neq 12 x 6



 Liscio / Smooth
H.250 x L.250 mm
Art. 03.714 \neq 16 x 8

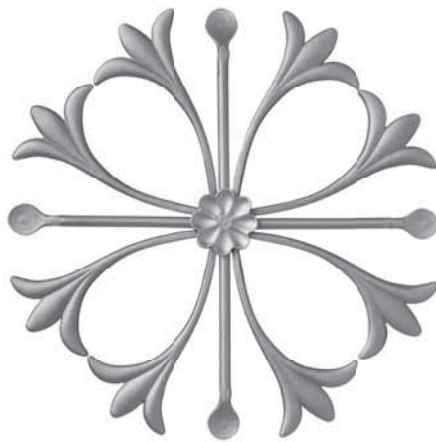

 Liscio / Smooth
H.380 x L.380 mm
Art. 03.715 \varnothing 10

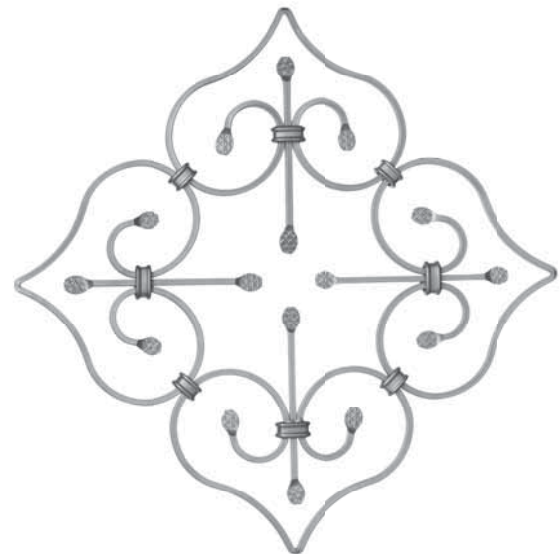

Liscio / Smooth
H.480 x L.480 mm
Art. 03.716 \neq 12 x 6

🌀 fiori da entrambi i lati / flowers on both sides

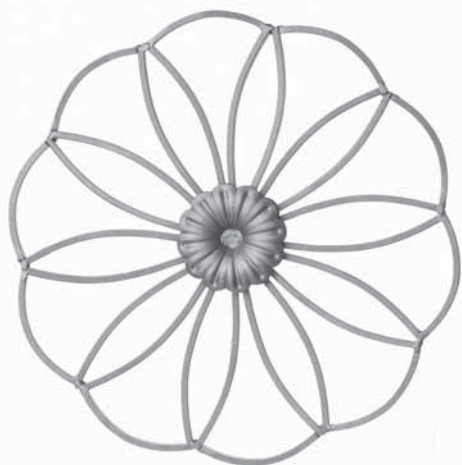

🌀 Liscio / Smooth
H.400 x L.400 mm
Art. 03.717 \neq 12 x 6
fiore / flower 95 mm

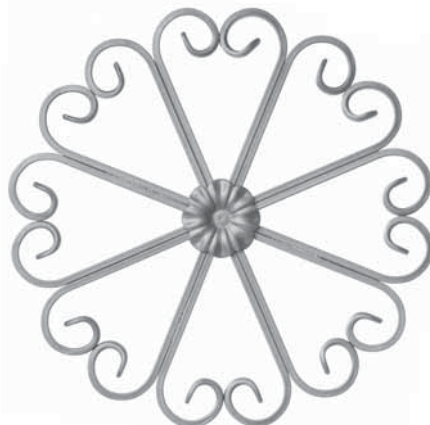

🌀 Liscio / Smooth
H.330 x L.330 mm
Art. 03.718 \neq 12 x 6
fiore / flower 60 mm



Mod. Scala / Scala model
Ø 270 mm
Art. 03.719 \neq 12 x 6



🌀 Liscio / Smooth
Ø 215 mm
Art. 03.720 \neq 14 x 6



🌀 Liscio / Smooth
Ø 190 mm
Art. 03.721 \neq 12 x 6

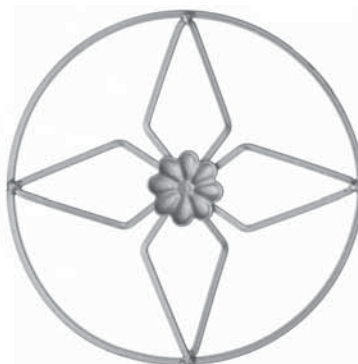

🌀 Liscio / Smooth
Ø 280 mm
Art. 03.722 \neq 12 x 6



🌀 Liscio / Smooth
Ø 220 mm
Art. 03.723 \neq 14 x 6

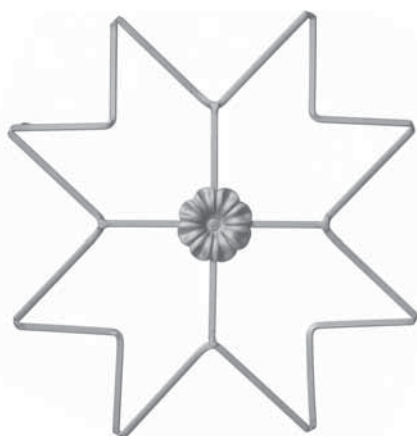

🌀 Liscio / Smooth
H.360 x L.360 mm
Art. 03.724 \neq 12 x 6
fiore / flower 60 mm

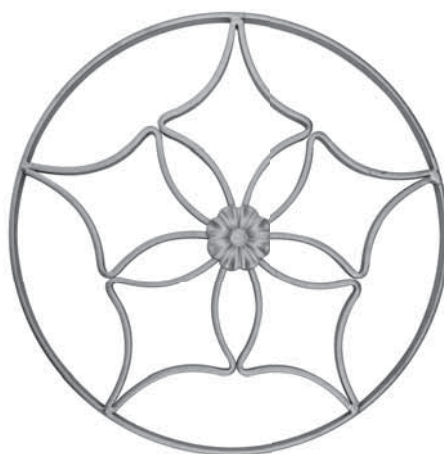

🌀 Liscio / Smooth
Ø 400 mm
Art. 03.725 \neq 12 x 6
fiore / flower 60 mm

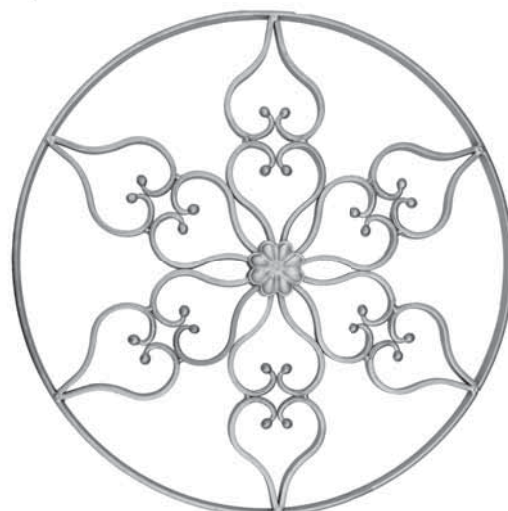

🌀 Liscio / Smooth
Ø 500 mm
Art. 03.726 \neq 12 x 6
fiore / flower 60 mm



Tutte le parti di questo catalogo - foto comprese - sono di proprietà Euro-Fer. La riproduzione, anche parziale, è vietata in ogni forma e con ogni mezzo. / Every part of this catalogue - photos included - is Euro-Fer's property. All forms of copying are strictly prohibited.

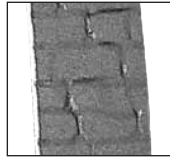

Modello Mattone
Brick Model



H.950 X L.300 mm. \neq 40 X 4
Art. 04.001 Liscio / Smooth
Art. 04.002 Mattone / Brick



H.720 X L.250 mm. \neq 40 X 4
Art. 04.003 Liscio / Smooth
Art. 04.004 Mattone / Brick



H.720 X L.250 mm. \neq 40 X 4
Art. 04.005 Liscio / Smooth
Art. 04.006 Mattone / Brick



H.950 X L.220 mm. \neq 40 X 4
Art. 04.007 Liscio / Smooth
Art. 04.008 Mattone / Brick



H.950 X L.180 mm. \neq 40 X 4
Art. 04.009 Liscio / Smooth
Art. 04.010 Mattone / Brick



H.370 X L.125 mm. \neq 40 X 4
Art. 04.011 Liscio / Smooth
Art. 04.012 Mattone / Brick



Liscio / Smooth
H.440 X L.75 mm.
Art. 04.012.01 \neq 40 X 4

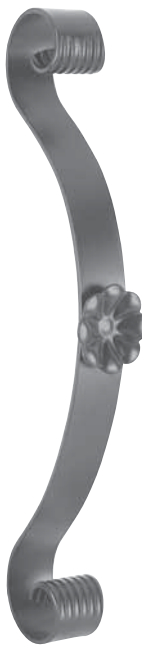

Liscio / Smooth
H.440 X L.75 mm.
Art. 04.012.02 \neq 40 X 4



Mattone / Brick
H.440 X L.75 mm.
Art. 04.012.03 \neq 40 X 4



Mattone / Brick
H.440 X L.75 mm.
Art. 04.012.04 \neq 40 X 4

Tutte le parti di questo catalogo - foto comprese - sono di proprietà Euro-Fer. La riproduzione, anche parziale, è vietata in ogni forma e con ogni mezzo. / Every part of this catalogue - photos included - is Euro-Fer's property. All forms of copying are strictly prohibited.



H.800 X L.135 mm. Liscio / Smooth

Art. 04.013 ≙ 20 X 4

Art. 04.014 ≙ 25 X 4

Art. 04.015 ≙ 30 X 4

Art. 04.016 ≙ 40 X 4



H.800 X L.135 mm. Mattone / Brick

Art. 04.017 ≙ 20 X 4

Art. 04.018 ≙ 25 X 4

Art. 04.019 ≙ 30 X 4

Art. 04.020 ≙ 40 X 4



H.900 X L.240 mm. ≙ 40 X 6

Art. 04.021 Liscio / Smooth



Liscio / Smooth

H.950 X L.240 mm.

Art. 04.021.01 ≙ 40 X 4



Liscio / Smooth

H.950 X L.240 mm.

Art. 04.021.02 ≙ 40 X 4



Liscio / Smooth

H.950 X L.240 mm.

Art. 04.021.03 ≙ 40 X 4



Mattone / Brick

H.950 X L.240 mm.

Art. 04.021.04 ≙ 40 X 4



Mattone / Brick

H.950 X L.240 mm.

Art. 04.021.05 ≙ 40 X 4



Mattone / Brick

H.950 X L.240 mm.

Art. 04.021.06 ≙ 40 X 4



H.950 x L.190 mm

Martellato / Hammered

Art. 04.021.10 ≙ 30 x 8 mm

Liscio / Smooth

Art. 04.021.11 ≙ 30 x 8 mm



H.750 X L.110 mm.
Art. 04.022 ≡ 20 X 4
Art. 04.023 ≡ 20 X 5



H.900 X L.180 mm.
Art. 04.024 ≡ 16 X 4
Art. 04.025 ≡ 20 X 6
Art. 04.026 □ 8 X 8



H.850 X L.170 mm.
Art. 04.027 ≡ 25 X 5



H.780 X L.250 mm.
Art. 04.028 ≡ 30 X 4
Art. 04.029 ≡ 25 X 5



Liscio / Smooth
H.730 x L.250 mm
Art. 04.029.01 ≡ 30 x 10



H.720 X L.130 mm.
Art. 04.030 ≡ 16 X 4
Art. 04.031 ≡ 10 X 5
Art. 04.032 ≡ 20 X 6
Art. 04.033 □ 8 X 8



H.720 X L.75 mm.
Art. 04.034 ≡ 16 X 4
Art. 04.035 ≡ 10 X 5
Art. 04.036 ≡ 20 X 6
Art. 04.037 □ 8 X 8



H.720 X L.75 mm.
Art. 04.038 ≡ 16 X 4
Art. 04.039 ≡ 10 X 5
Art. 04.040 ≡ 20 X 6
Art. 04.041 □ 8 X 8



H.800 X L.115 mm.
Art. 04.042 ≡ 16 X 4
Art. 04.043 ≡ 20 X 4
Art. 04.044 ≡ 25 X 4



H.720 X L.75 mm.
Art. 04.045 ≡ 16 X 4
Art. 04.046 ≡ 10 X 5
Art. 04.047 ≡ 20 X 6

Tutte le parti di questo catalogo - foto comprese - sono di proprietà Euro-Fer. La riproduzione, anche parziale, è vietata in ogni forma e con ogni mezzo. / Every part of this catalogue - photos included - is Euro-Fer's property. All forms of copying are strictly prohibited.



Modello Scala / *Scala Model*
 L.100 mm. \neq 20 X 6
 Art. 04.048.01 H.1000 mm.
 Art. 04.048.02 H.1500 mm.



Modello Mattone / *Brick Model*
 H. 1000 X L.110 mm.
 Art. 04.048.03 \square 12 X 12



H.950 X L.100 mm.
 Art. 04.048.04 \neq 12 X 6
 Art. 04.048.05 \neq 14 X 6



NEW



H.1000 x L.160 mm
 Mattone / *Brick*
 Art. 04.048.10 \neq 40 x 8 mm



NEW



H.1000 x L.120 mm
 Mattone / *Brick*
 Art. 04.048.11 \neq 40 x 8 mm



H.950 X L.100 mm.
 Art. 04.048.06 \square 12 X 12
 Art. 04.048.07 \square 14 X 14



H.950 X L.125 mm.
 Art. 04.048.08 \neq 12 X 6
 Art. 04.048.09 \neq 14 X 6



Tutte le parti di questo catalogo - foto comprese - sono di proprietà Euro-Fer. La riproduzione, anche parziale, è vietata in ogni forma e con ogni mezzo. / Every part of this catalogue - photos included - is Euro-Fer's property. All forms of copying are strictly prohibited.



L.170 mm. □ 10 X 10
Art. 04.049 H. 720 mm.
Art. 04.050 H. 820 mm.
Art. 04.051 H. 900 mm.
Art. 04.052 H.1000 mm.
 L.170 mm. □ 12 X 12
Art. 04.053 H. 720 mm.
Art. 04.054 H. 820 mm.
Art. 04.055 H. 900 mm.
Art. 04.056 H.1000 mm.



L.115 mm. □ 12 X 12
Art. 04.056.01 H. 650 mm.
Art. 04.056.02 H. 720 mm.
Art. 04.056.03 H.1200 mm.



Martellato / Hammered
 L.90 mm. □ 12 X 12
Art. 04.056.07 H. 650 mm.
Art. 04.056.08 H. 720 mm.
Art. 04.056.09 H.1200 mm.



H.520 X L.200 mm.
Art. 04.056.13 □ 12 X 12
Art. 04.056.17 □ 14 X 14
Art. 04.056.18 □ 16 X 16



H.690 X L.260 mm.
Art. 04.056.14 □ 20 X 20

L.115 mm. □ 14 X 14
Art. 04.056.04 H. 650 mm.
Art. 04.056.05 H. 720 mm.
Art. 04.056.06 H.1200 mm.

L.90 mm. □ 14 X 14
Art. 04.056.10 H. 650 mm.
Art. 04.056.11 H. 720 mm.
Art. 04.056.12 H.1200 mm.



L.235 mm. ≡ 20 X 6
Art. 04.056.15 H.660 mm.
Art. 04.056.16 H.760 mm.



Liscio / Smooth
 H.600 x L.290 mm
Art. 04.056.20 □ 12



L.250 mm. □ 12 X 12
Art. 04.057 H. 720 mm.
Art. 04.058 H. 820 mm.
Art. 04.059 H. 900 mm.
Art. 04.060 H. 1200 mm.
Art. 04.061 H. 1500 mm.
Art. 04.062 H. 1800 mm.

L.250 mm. □ 14 X 14
Art. 04.057.01 H. 720 mm.
Art. 04.058.01 H. 820 mm.
Art. 04.059.01 H. 900 mm.
Art. 04.060.01 H.1200 mm.
Art. 04.061.01 H.1500 mm.
Art. 04.062.01 H.1800 mm.

L.250 mm. □ 16 X 16
Art. 04.057.02 H. 720 mm.
Art. 04.058.02 H. 820 mm.
Art. 04.059.02 H. 900 mm.
Art. 04.060.02 H.1200 mm.
Art. 04.061.02 H 1500 mm.
Art. 04.062.02 H 1800 mm.

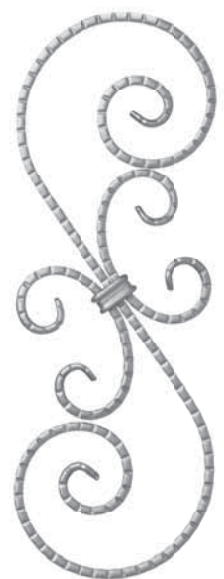

Modello Scala / Scala Model
 H.380 x L.135 mm
Art. 04.062.10 ≡ 12 x 6 mm

NEW



Rigato / Fluted

L.210 mm. □ 12 X 12
Art. 04.063 H.1000 mm.
Art. 04.064 H.1200 mm.



Rigato / Fluted

L.210 mm. □ 12 X 12
Art. 04.065 H.1000 mm.
Art. 04.066 H.1200 mm.



L.200 mm. □ 12 X 12
Art. 04.067 H. 950 mm.
Art. 04.068 H.1200 mm.
Art. 04.069 H.1500 mm.
Art. 04.070 H.1800 mm.



L.125 mm. □ 12 X 12
Art. 04.075 H. 950 mm.
Art. 04.076 H.1200 mm.
Art. 04.077 H.1500 mm.
Art. 04.078 H.1800 mm.



L.125 mm. □ 12 X 12
Art. 04.083 H. 950 mm.
Art. 04.084 H.1200 mm.
Art. 04.085 H.1500 mm.
Art. 04.086 H.1800 mm.



Liscio / Smooth
 H.950 X L.205 mm.
Art. 04.090.01 □ 14 X 14

L.200 mm. □ 14 X 14
Art. 04.071 H. 950 mm.
Art. 04.072 H.1200 mm.
Art. 04.073 H.1500 mm.
Art. 04.074 H.1800 mm.

L.125 mm. □ 14 X 14
Art. 04.079 H. 950 mm.
Art. 04.080 H.1200 mm.
Art. 04.081 H.1500 mm.
Art. 04.082 H.1800 mm.

L.125 mm. □ 14 X 14
Art. 04.087 H. 950 mm.
Art. 04.088 H.1200 mm.
Art. 04.089 H.1500 mm.
Art. 04.090 H.1800 mm.



Martellato / Hammered
 H.950 x L.125 mm
Art. 04.090.09 □ 12 X 12 mm



Liscio / Smooth
 H.950 mm
Art. 04.090.10 □ 12
Art. 04.090.11 □ 14
Art. 04.090.12 □ 16



L.200 mm. □ 12 X 12
Art. 04.091 H. 950 mm.
Art. 04.092 H.1200 mm.
Art. 04.093 H.1500 mm.
Art. 04.094 H.1800 mm.



H.950 X L.170 mm.
Art. 04.095 □ 12 X 12



H.540 X L.115 mm.
Art. 04.096 □ 10 X 10
Art. 04.097 □ 12 X 12



Martellato / Hammered
 H.540 X L.115 mm.
Art. 04.098 □ 12 X 12

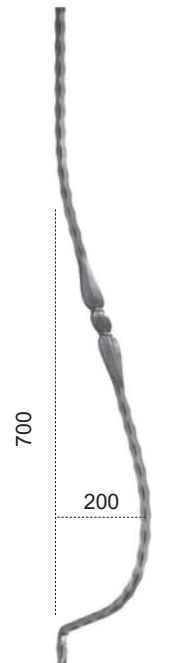

Martellato / Hammered
 L.200 mm. □ 12 X 12
Art. 04.098.01 H. 950 mm.
Art. 04.098.02 H.1200 mm.
Art. 04.098.03 H.1500 mm.
Art. 04.098.04 H.1800 mm.
 L.200 mm. □ 14 X 14
Art. 04.098.05 H. 950 mm.
Art. 04.098.06 H.1200 mm.
Art. 04.098.07 H.1500 mm.
Art. 04.098.08 H.1800 mm.

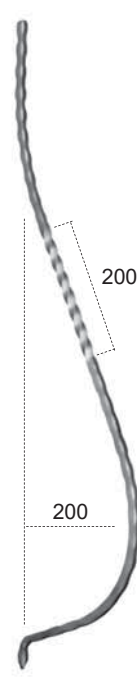

Tondo / Round

L.200 mm. □ 12 X 12
Art. 04.098.09 H. 950 mm.
Art. 04.098.10 H.1200 mm.
Art. 04.098.11 H.1500 mm.
Art. 04.098.12 H.1800 mm.

L.200 mm. Ø 14
Art. 04.098.17 H. 950 mm.
Art. 04.098.18 H.1200 mm.
Art. 04.098.19 H.1500 mm.
Art. 04.098.20 H.1800 mm.

L.200 mm. □ 12 X 12
Art. 04.098.25 H. 950 mm.
Art. 04.098.26 H.1200 mm.
Art. 04.098.27 H.1500 mm.
Art. 04.098.28 H.1800 mm.

Martellato / Hammered

L.200 mm. □ 12 X 12
Art. 04.099 H. 950 mm.
Art. 04.100 H.1200 mm.
Art. 04.101 H.1500 mm.
Art. 04.102 H.1800 mm.

Martellato / Hammered

L.200 mm. □ 12 X 12
Art. 04.103 H. 950 mm.
Art. 04.104 H.1200 mm.
Art. 04.105 H.1500 mm.
Art. 04.106 H.1800 mm.

L.200 mm. □ 12 X 12
Art. 04.106.05 H. 950 mm.
Art. 04.106.06 H.1200 mm.
Art. 04.106.07 H.1500 mm.
Art. 04.106.08 H.1800 mm.

L.200 mm. □ 14 X 14
Art. 04.098.13 H. 950 mm.
Art. 04.098.14 H.1200 mm.
Art. 04.098.15 H.1500 mm.
Art. 04.098.16 H.1800 mm.

L.200 mm. Ø 16
Art. 04.098.21 H. 950 mm.
Art. 04.098.22 H.1200 mm.
Art. 04.098.23 H.1500 mm.
Art. 04.098.24 H.1800 mm.

L.200 mm. □ 14 X 14
Art. 04.098.29 H. 950 mm.
Art. 04.098.30 H.1200 mm.
Art. 04.098.31 H.1500 mm.
Art. 04.098.32 H.1800 mm.

L.200 mm. □ 14 X 14
Art. 04.106.01 H. 950 mm.
Art. 04.106.02 H.1200 mm.
Art. 04.106.03 H.1500 mm.
Art. 04.106.04 H.1800 mm.

L.200 mm. □ 14 X 14
Art. 04.106.09 H. 950 mm.
Art. 04.106.10 H.1200 mm.
Art. 04.106.11 H.1500 mm.
Art. 04.106.12 H.1800 mm.



Tondo / Round

L.200 mm. Ø 14
Art. 04.106.13 H. 950 mm.
Art. 04.106.14 H.1200 mm.
Art. 04.106.15 H.1500 mm.
Art. 04.106.16 H.1800 mm.

L.200 mm. Ø 16
Art. 04.106.17 H. 950 mm.
Art. 04.106.18 H.1200 mm.
Art. 04.106.19 H.1500 mm.
Art. 04.106.20 H.1800 mm.

L.200 mm. Ø 12
Art. 04.106.40 H. 950 mm.
Art. 04.106.41 H.1200 mm. **NEW**
Art. 04.106.42 H.1500 mm.
Art. 04.106.43 H.1800 mm.



*Attorcigliato, Martellato e Rigato
 Fluted, Hammered and Twisted*
 L.200 mm. □ 14 X 14
Art. 04.106.21 H.950 mm.



Martellato / Hammered
 L.200 mm. □ 12 X 12
Art. 04.106.30 H.950 mm.



Martellato / Hammered
 L.200 mm. □ 12 X 12
Art. 04.106.31 H.950 mm.



Martellato / Hammered
 L.200 mm. □ 12 X 12
Art. 04.107 H. 950 mm.
Art. 04.108 H.1200 mm.
Art. 04.109 H.1500 mm.
Art. 04.110 H.1800 mm.

L.200 mm. □ 14 X 14
Art. 04.110.01 H. 950 mm.
Art. 04.110.02 H.1200 mm.
Art. 04.110.03 H.1500 mm.
Art. 04.110.04 H.1800 mm.

Tutte le parti di questo catalogo - foto comprese - sono di proprietà Euro-Fer. La riproduzione, anche parziale, è vietata in ogni forma e con ogni mezzo. / Every part of this catalogue - photos included - is Euro-Fer's property. All forms of copying are strictly prohibited.



L.200 mm. □ 12 X 12
 Art. 04.110.05 H. 950 mm.
 Art. 04.110.06 H.1200 mm.
 Art. 04.110.07 H.1500 mm.
 Art. 04.110.08 H.1800 mm.

Martellato / Hammered
 L.200 mm. □ 12 X 12
 Art. 04.111 H. 950 mm.
 Art. 04.112 H.1200 mm.
 Art. 04.113 H.1500 mm.
 Art. 04.114 H.1800 mm.

L.200 mm. □ 12 X 12
 Art. 04.114.05 H. 950 mm.
 Art. 04.114.06 H.1200 mm.
 Art. 04.114.07 H.1500 mm.
 Art. 04.114.08 H.1800 mm.

Martellato / Hammered
 L.200 mm. □ 12 X 12
 Art. 04.115 H. 950 mm.
 Art. 04.116 H.1200 mm.
 Art. 04.117 H.1500 mm.
 Art. 04.118 H.1800 mm.

L.200 mm. □ 12 X 12
 Art. 04.118.05 H. 950 mm.
 Art. 04.118.06 H.1200 mm.
 Art. 04.118.07 H.1500 mm.
 Art. 04.118.08 H.1800 mm.

Forgiato / Forged
 H.950 x L.150 mm
 Art. 04.118.40 ≙ 13 x 10 mm

L.200 mm. □ 14 X 14
 Art. 04.110.09 H. 950 mm.
 Art. 04.110.10 H.1200 mm.
 Art. 04.110.11 H.1500 mm.
 Art. 04.110.12 H.1800 mm.

L.200 mm. □ 14 X 14
 Art. 04.114.01 H. 950 mm.
 Art. 04.114.02 H.1200 mm.
 Art. 04.114.03 H.1500 mm.
 Art. 04.114.04 H.1800 mm.

L.200 mm. □ 14 X 14
 Art. 04.114.09 H. 950 mm.
 Art. 04.114.10 H.1200 mm.
 Art. 04.114.11 H.1500 mm.
 Art. 04.114.12 H.1800 mm.

L.200 mm. □ 14 X 14
 Art. 04.118.01 H. 950 mm.
 Art. 04.118.02 H.1200 mm.
 Art. 04.118.03 H.1500 mm.
 Art. 04.118.04 H.1800 mm.

L.200 mm. □ 14 X 14
 Art. 04.118.09 H. 950 mm.
 Art. 04.118.10 H.1200 mm.
 Art. 04.118.11 H.1500 mm.
 Art. 04.118.12 H.1800 mm.



Forgiato / Forged
 H.950 x L.150 mm
 Art. 04.118.45 ≙ 13 x 10 mm



LISCIO / SMOOTH
 H.720 x L.260mm
 Art. 04.118.99 Ø 12



H.730 X L.250 mm.
 Art. 04.119 ≙ 20 X 6



Modello Scala / Scala Model
 H.730 X L.250 mm.
 Art. 04.119.01 ≙ 20 X 6



Tondo / Round
 H.750 X L.250 mm.
 Art. 04.119.02 Ø 14



H.470 X L.180 mm.
 Art. 04.119.03 ≙ 20 X 6



NEW

Tondo / Round
 H.480 x L.190 mm
 Art. 04.119.13 Ø 12
 liscio / smooth



H.850 X L.235 mm. Sinistro/Left
Art. 04.119.04 ≡ 20 X 6
H.950 X L.235 mm. Sinistro/Left
Art. 04.119.06 ≡ 20 X 6



H.850 X L.235 mm. Destro/Right
Art. 04.119.05 ≡ 20 X 6
H.950 X L.235 mm. Destro/Right
Art. 04.119.07 ≡ 20 X 6



Martellato / Hammered
H.900 X L.380 mm.
Art. 04.119.08 □ 25 X 25



Martellato / Hammered
H.750 X L.350 mm.
Art. 04.119.09 □ 12 mm ≡ 12 X 6
Art. 04.119.10 □ 14 mm ≡ 12 X 6
Art. 04.120 □ 16 mm ≡ 16 X 8



Martellato / Hammered
H.480 X L.220 mm.
Art. 04.120.01 □ 12 mm ≡ 12 X 6
Art. 04.120.02 □ 14 mm ≡ 12 X 6
Art. 04.120.03 □ 16 mm ≡ 16 X 8



Battuto / Wrought
H.800 X L.305 mm.
Art. 04.120.04 ≡ 25 X 10



H.700 X L.250 mm.
Art. 04.120.05 ≡ 20 X 8



H.730 X L.240 mm.
Art. 04.121 ≡ 20 X 6



Modello Scala / Scala Model
H.730 X L.240 mm.
Art. 04.121.01 ≡ 20 X 6



Liscio / Smooth
H.740 X L.250 mm.
Art. 04.140 □ 10 mm



Liscio / Smooth
H.770 X L.280 mm.
Art. 04.141 Ø 25 mm



Rigato / Fluted
H.550 X L.250 mm.
Art. 04.142 ≡ 16 X 8



Liscio / Smooth
H.570 X L.160 mm.
Art. 04.143 ≡ 14 X 6
Art. 04.143.01 ≡ 16 X 6

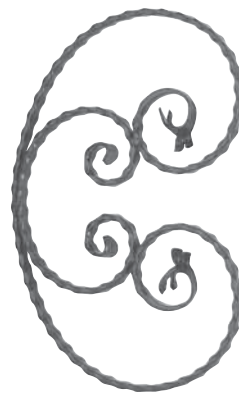

Martellato / Hammered
H.480 X L.330 mm.
Art. 04.145 ≡ 18 X 10



Liscio / Smooth
H.885 X L.265 mm.
Art. 04.146 Ø 12 mm
Art. 04.146.01 Ø 14 mm
Art. 04.146.02 Ø 16 mm

Tutte le parti di questo catalogo - foto comprese - sono di proprietà Euro-Fer. La riproduzione, anche parziale, è vietata in ogni forma e con ogni mezzo. / Every part of this catalogue - photos included - is Euro-Fer's property. All forms of copying are strictly prohibited.



Gli articoli della Linea Liberty possono includere particolari in ghisa o ferro fuso.
The items of the Liberty Line could contain casting parts.



H.280 x L.210 mm
 Art. 04.400 Ø 10 mm
 Sinistro / Left



H.280 x L.210 mm
 Art. 04.401 Ø 10 mm
 Destro / Right

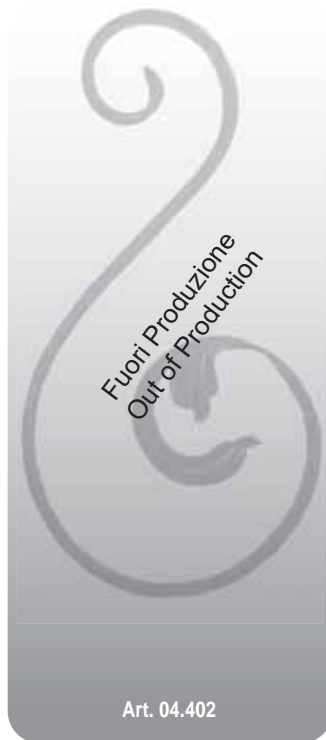

Art. 04.402



Art. 04.403



Martellato / Hammered
 H.400 x L.250 mm
 Art. 04.404 ≠ 16 X 8 mm
 Sinistro / Left



Martellato / Hammered
 H.400 x L.250 mm
 Art. 04.405 ≠ 16 x 8 mm
 Destro / Right



Martellato / Hammered
 H.450 x L.300 mm
 Art. 04.406 ≠ 16 x 8 mm
 Sinistro / Left



Martellato / Hammered
 H.450 x L.300 mm
 Art. 04.407 ≠ 16 x 8 mm
 Destro / Right



Martellato / Hammered
H.500 x L.260 mm
Art. 04.408 ≠ 16 x 8 mm
Sinistro / Left



Martellato / Hammered
H.500 x L.260 mm
Art. 04.409 ≠ 16 X 8 mm
Destro / Right



H.370 X L.330 mm.
Art. 04.500 Ø 12 mm



H.370 X L.330 mm.
Art. 04.501 Ø 12 mm



H.460 X L.440 mm.
Art. 04.502 Ø 12 mm



H.460 X L.440 mm.
Art. 04.503 Ø 12 mm



H.620 X L.410 mm.
Art. 04.505 Ø 12 mm



H.620 X L.410 mm.
Art. 04.506 Ø 12 mm



H.970 X L.780 mm.
Art. 04.507 Ø 12 mm



H.970 X L.780 mm.
Art. 04.508 Ø 12 mm



H.970 X L.780 mm.
Art. 04.509 Ø 12 mm



H.970 X L.780 mm.
Art. 04.510 Ø 12 mm



H.550 x L.750 mm
Art. 04.516 Ø 12 mm

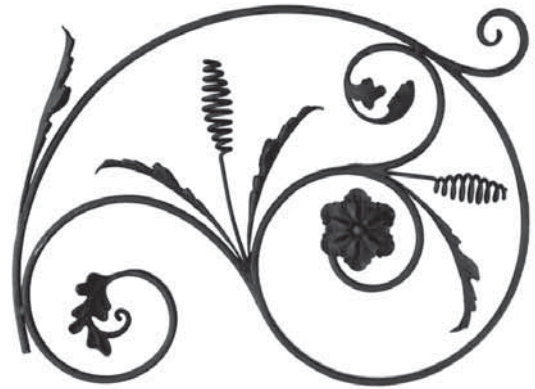

H.550 X L.750 mm.
Art. 04.517 Ø 12 mm



H.970 X L.420 mm.
Art. 04.520 Ø 12 mm



H.970 X L.420 mm.
Art. 04.521 Ø 12 mm



Art. 04.522



Art. 04.523



Rigato / Fluted
H.715 x L.190 mm
Art. 04.528 \neq 16 x 8 mm
Sinistro / Left



Rigato / Fluted
H.715 x L.190 mm
Art. 04.529 \neq 16 x 8 mm
Destro / Right

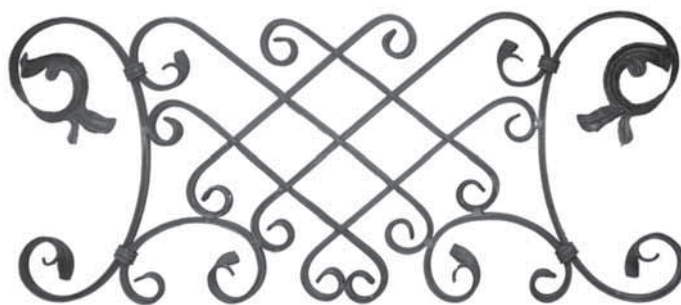

Rigato / Fluted
H.370 X L.880 mm.
Art. 04.530 \neq 16 X 8



Rigato / Fluted
H.710 X L.640 mm.
Art. 04.531 \neq 16 X 8

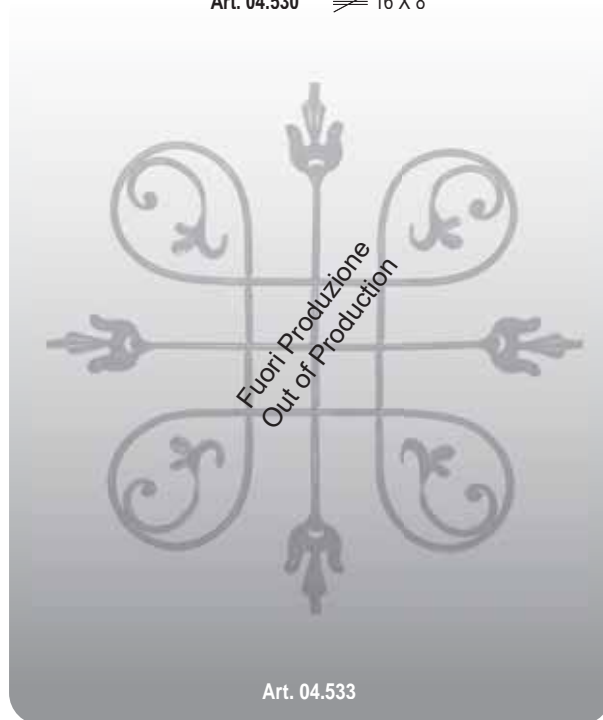

Art. 04.533

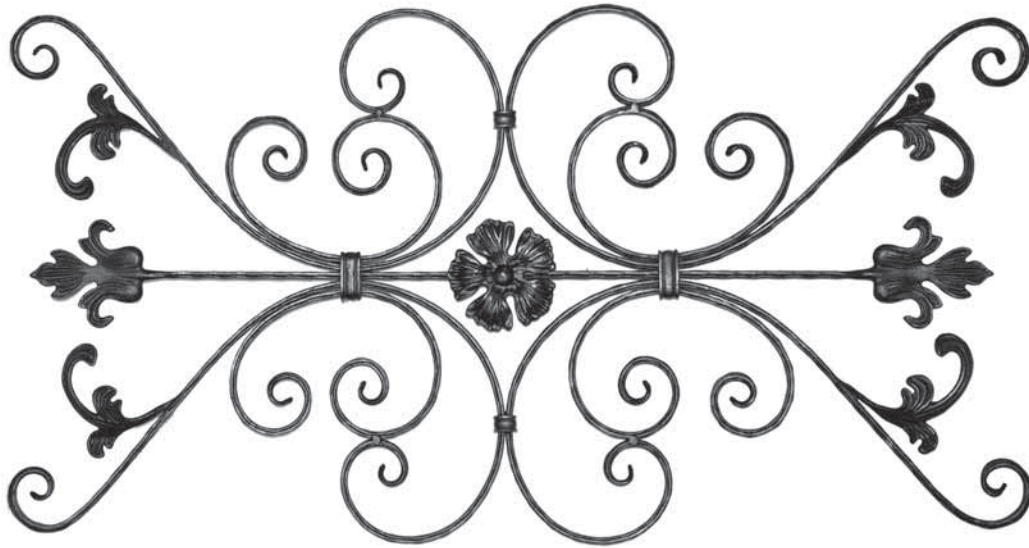

Rigato / Fluted
H.540 x L.1010 mm
Art. 04.536 \neq 20 X 8 mm



Martellato / Hammered
H.900 x L.350 mm
Art. 04.538 \square 12 mm



Martellato / Hammered
H.440 x L.330 mm
Art. 04.580



Martellato / Hammered
H.410 x L.370 mm
Art. 04.581



Tutte le parti di questo catalogo - foto comprese - sono di proprietà Euro-Fer. La riproduzione, anche parziale, è vietata in ogni forma e con ogni mezzo. / Every part of this catalogue - photos included - is Euro-Fer's property. All forms of copying are strictly prohibited.

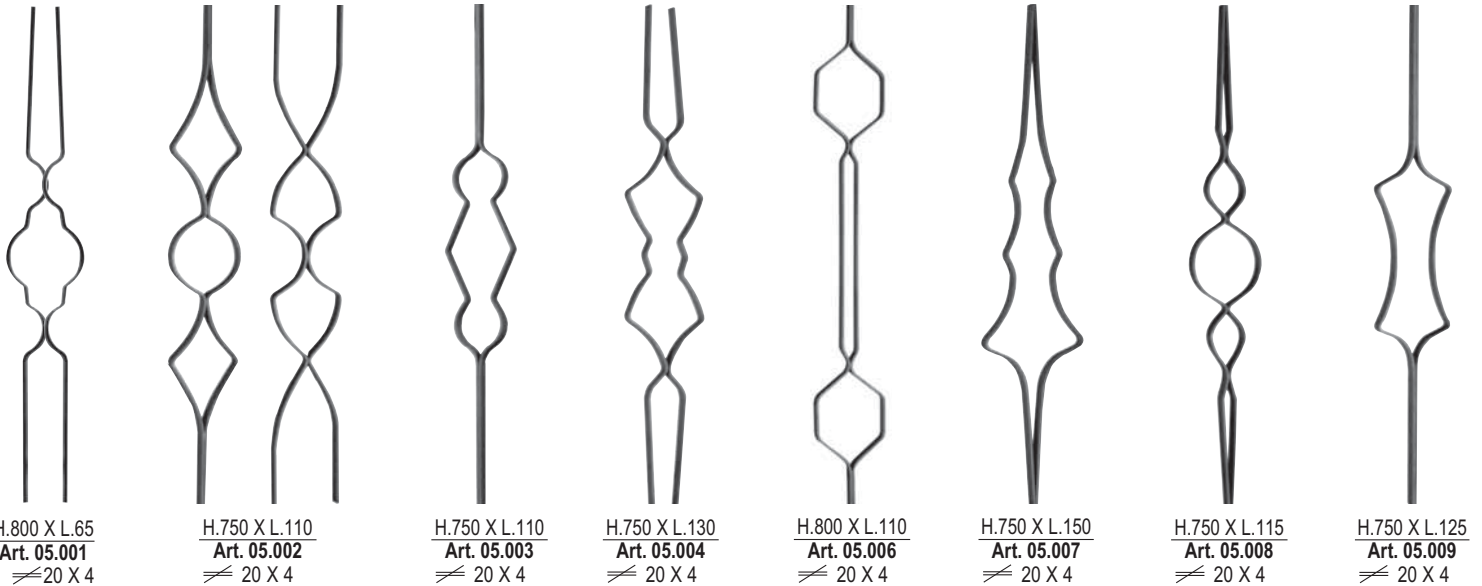

Gli elementi indicati qui sopra sono venduti singolarmente: sono accoppiati a titolo dimostrativo / The elements in the line above are sold separately: they are only in pairs for demonstration purposes

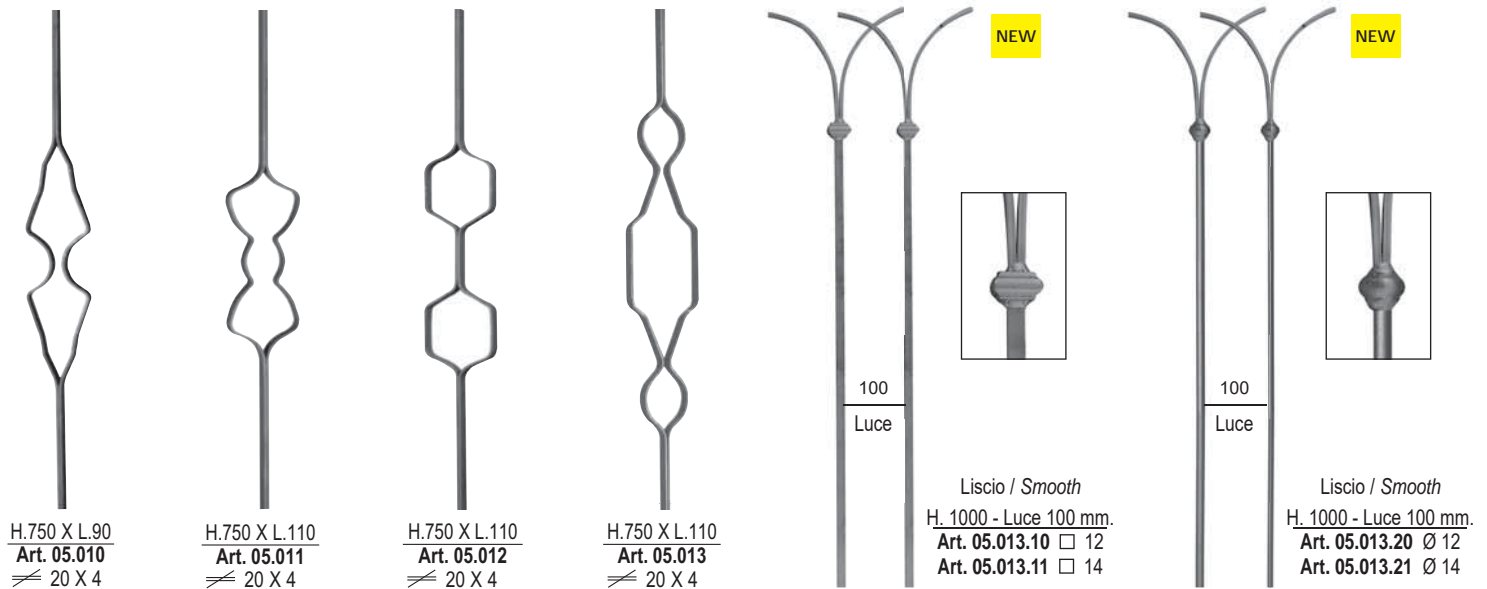

Gli elementi indicati qui sopra sono venduti singolarmente: sono accoppiati a titolo dimostrativo / The elements in the line above are sold separately: they are only in pairs for demonstration purposes

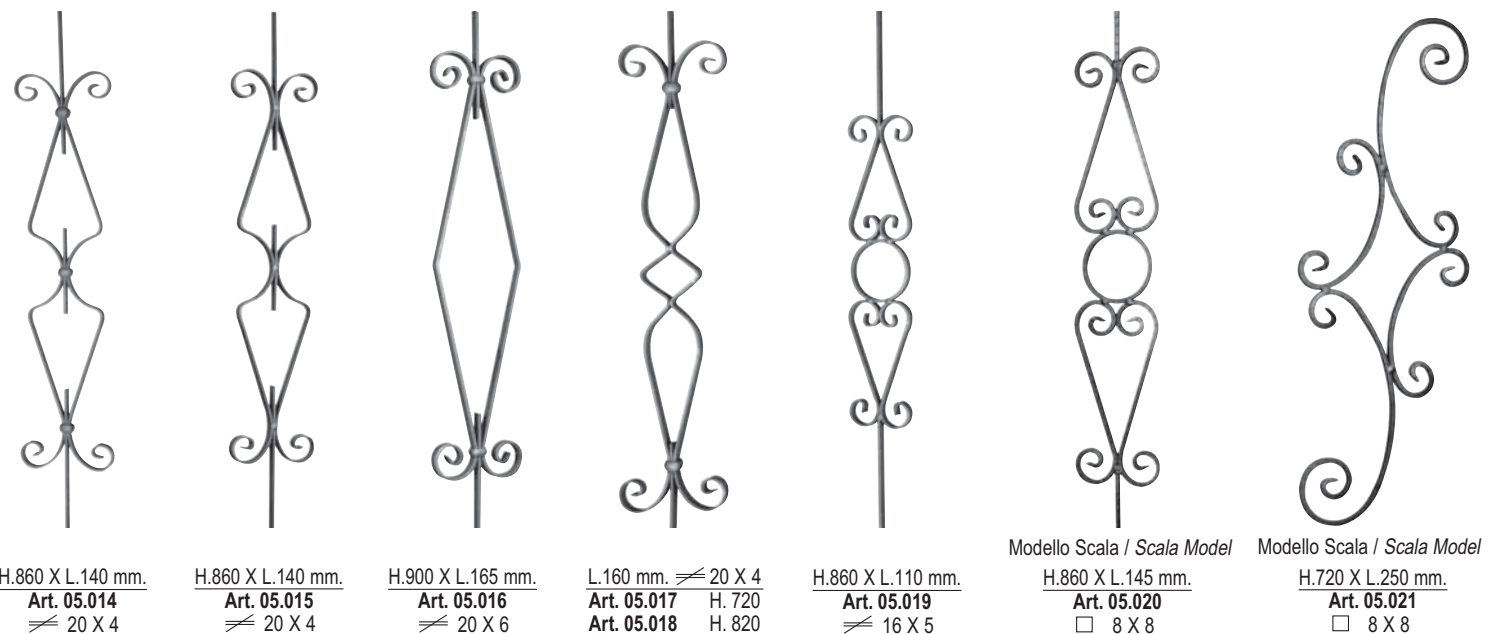

Tutte le parti di questo catalogo - foto comprese - sono di proprietà Euro-Fer. La riproduzione, anche parziale, è vietata in ogni forma e con ogni mezzo. / Every part of this catalogue - photos included - is Euro-Fer's property. All forms of copying are strictly prohibited.



H.720 X L.250 mm.
Art. 05.023
 ≧ 16 X 4



Tondo / Round
 H.870 X L.260 mm.
Art. 05.023.01
 Ø 12



H.720 X L.250 mm.
Art. 05.024
 ≧ 16 X 4



H.720 X L.250 mm.
Art. 05.025
 ≧ 16 X 4

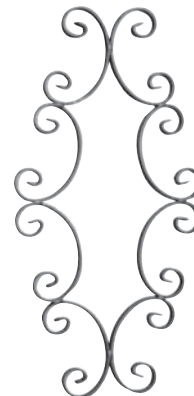

H.540 X L.250 mm.
Art. 05.026
 ≧ 16 X 4



H.720 X L.330 mm.
Art. 05.028
 ≧ 16 X 4



Ferro Spigolato
Edged Bar
 H.950 X L.125 mm.
Art. 05.029
 □ 14 X 14

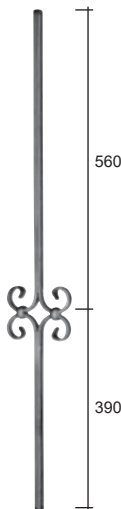

Ferro Spigolato
Edged Bar
 H.950 X L.125 mm.
Art. 05.030
 □ 14 X 14



Ferro Spigolato
Edged Bar
 H.950 X L.125 mm.
Art. 05.031
 □ 14 X 14



H.750 X L.200 mm.
Art. 05.032
 3 ≧ 16 X 4



H.750 X L.200 mm.
Art. 05.033
 3 ≧ 16 X 4



H.750 X L.200 mm.
Art. 05.034
 4 ≧ 16 X 4



H.750 X L.200 mm.
Art. 05.035
 4 ≧ 16 X 4



H.750 X L.200 mm.
Art. 05.036
 3 ≧ 16 X 4



H.750 X L.200 mm.
Art. 05.037
 3 ≧ 16 X 4



H.750 mm.
Art. 05.038 ≧ 16 X 4
Art. 05.039 ≧ 20 X 4

H.850 mm.
Art. 05.040 ≧ 16 X 4
Art. 05.041 ≧ 20 X 4

H.900 mm.
Art. 05.042 ≧ 16 X 4
Art. 05.043 ≧ 20 X 4

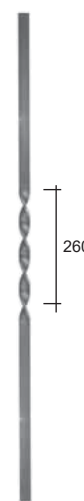

H.950 mm.
Art. 05.043.01
 ≧ 20 X 6



H.950 mm.
Art. 05.043.02
 ≧ 20 X 6

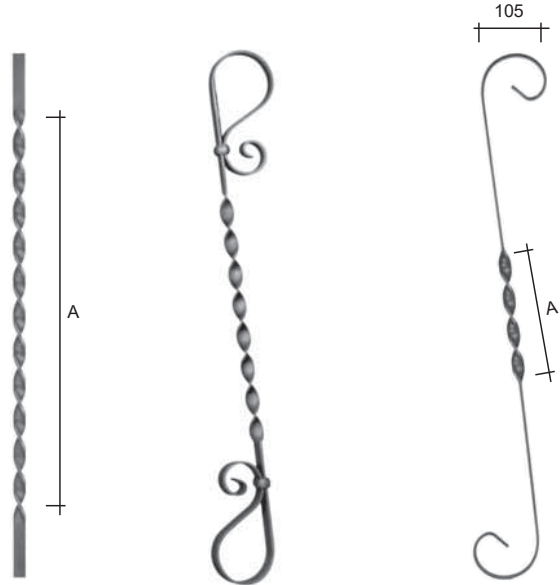

H.720 mm.
Art. 05.043.03
≠ 20 X 6
A = 550 mm.
H.950 mm.
Art. 05.043.04
≠ 20 X 6
A = 700 mm.

H.730 X L.90 mm.
Art. 05.044
≠ 20 X 4

H.350 mm. - A = 100 mm.
Art. 05.044.01 ≠ 20 X 5
H.650 mm. - A = 220 mm.
Art. 05.044.02 ≠ 20 X 5
H.850 mm. - A = 220 mm.
Art. 05.044.03 ≠ 20 X 5
H.950 mm. - A = 220 mm.
Art. 05.044.04 ≠ 20 X 5



H.950 mm.
Art. 05.045 □12
Art. 05.045.01 □14
Art. 05.045.02 □16



H.950 mm.
Art. 05.046 □12
Art. 05.046.01 □14
Art. 05.046.02 □16



H.750 mm.
Art. 05.047 □8
Art. 05.048 □10
Art. 05.049 □12
Art. 05.050 □14
Art. 05.051 □16



H.950 mm.
Art. 05.062 □12



H.950 mm.
Art. 05.063 □12



H.950 X L.110 mm.
Art. 05.064
□12 ≠ 12 X 4



H.950 X L.165 mm.
Art. 05.065
□12 ≠ 12 X 6



H.950 X L.165 mm.
Art. 05.066
□12 ≠ 12 X 6

H.1200 mm.
Art. 05.045.03 □12
Art. 05.045.04 □14
Art. 05.045.05 □16

H.1500 mm.
Art. 05.045.06 □12
Art. 05.045.07 □14
Art. 05.045.08 □16

H.850 mm.
Art. 05.052 □8
Art. 05.053 □10
Art. 05.054 □12
Art. 05.055 □14
Art. 05.056 □16

H.950 mm.
Art. 05.057 □8
Art. 05.058 □10
Art. 05.059 □12
Art. 05.060 □14
Art. 05.061 □16





H.950 X L.170 mm.
Art. 05.067
 □12 ≙ 12 X 6



H.950 X L.170 mm.
Art. 05.068
 □12 ≙ 12 X 6



H.950 X L.110 mm.
Art. 05.069
 □12 ≙ 12 X 6



H.950 X L.140 mm.
Art. 05.070
 □12 ≙ 12 X 6



H.950 X L.140 mm.
Art. 05.071
 □12 ≙ 12 X 6



H.950 X L.155 mm.
Art. 05.071.01
 □12 ≙ 12 X 6

H.950 X L.155 mm.
Art. 05.071.02
 □14 ≙ 14 X 6



H.950 X L.155 mm.
Art. 05.071.03
 □12 ≙ 12 X 6

H.950 X L.155 mm.
Art. 05.071.04
 □14 ≙ 14 X 6



H.950 X L.220 mm.
Art. 05.072
 □12 ≙ 12 X 6



H.950 X L.180 mm.
Art. 05.073
 □12 ≙ 12 X 6



H.950 X L.220 mm.
Art. 05.074
 □12 ≙ 12 X 6



H.950 X L.170 mm.
Art. 05.075
 □12 ≙ 12 X 6



H.950 X L.180 mm.
Art. 05.076
 □12 ≙ 12 X 6



H.1200 X L.185 mm
Art. 05.076.01
 □16 ≙ 16 X 4



H.950 x L.180 mm
Art. 05.076.02
 □12 mm ≙ 12 x 6



H.950 X L.220 mm.
Art. 05.077
 □12 ≙ 12 X 6



H.950 X L.240 mm.
Art. 05.078
 □12 ≙ 12 X 6



H.950 X L.150 mm.
Art. 05.079
 □12 ≙ 12 X 6



H.950 X L.220 mm.
Art. 05.080
 □12 ≙ 12 X 6



H.950 X L.150 mm.
Art. 05.081
 □12 ≙ 12 X 6



H.950 x L.100 mm
Art. 05.081.50 □14



H.950 X L.220 mm.
Art. 05.082
 □12 ≙ 12 X 6



H.950 X L.210 mm.
Art. 05.083
□12 ≙12 X 4

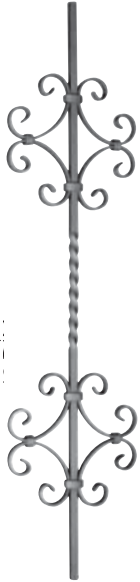

H.950 X L.270 mm.
Art. 05.085
□12 ≙12 X 6

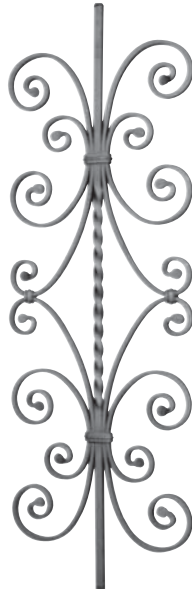

H.950 X L.300 mm.
Art. 05.086
□12 ≙12 X 6



H.950 X L.220 mm.
Art. 05.087
□12 ≙12 X 6



H.950 X L.275 mm.
Art. 05.088
□12 ≙12 X 6



H.950 X L.180 mm.
Art. 05.088.01
□12 ≙12 X 6

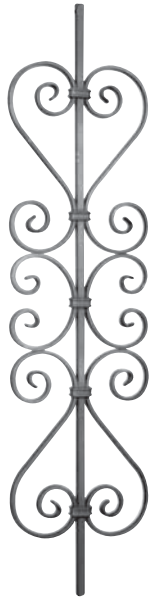

H.950 X L.220 mm.
Art. 05.089
□12 ≙12 X 6

H.950 X L.210 mm.
Art. 05.084
□12 ≙12 X 4



NEW



Liscio / Smooth
H. 950 X L. 72 mm.
Art. 05.089.10
□ 12

NEW



Liscio / Smooth
H. 950 X L. 72 mm.
Art. 05.089.11
□ 12

PANNELLI LISCI E PALETTI PER RECINZIONI
PLAIN PANEL UNITS AND STAKES FOR FENCES



H.950 X L.190 mm.
Art. 05.090
□12 ≙ 12 X 6



H.950 X L.190 mm.
Art. 05.091
□12 ≙ 12 X 6



H.950 X L.100 mm.
Art. 05.092
≙ 40 X 4



H.950 X L.100 mm.
Art. 05.093
≙ 40 X 4



Tondo / Round
H.950 X L.130 mm.
Art. 05.094 ØØ12



Tondo / Round
H.950 X L.130 mm.
Art. 05.094.01 ØØ12



Tondo / Round
H.950 X L.130 mm.
Art. 05.094.02 ØØ12



Tondo / Round
H.950 X L.270 mm.
Art. 05.094.03 ØØ12



Tondo / Round
H.900 X L.360 mm.
Art. 05.094.04 Ø14



Tondo / Round
H.900 X L.360 mm.
Art. 05.094.05 Ø14



H.950 X L.125 mm.
Art. 05.095 □ 12



H.800 X L.100 mm.
Art. 05.096 □ 8
Art. 05.097 □ 10



H.800 X L.100 mm.
Art. 05.100 □ 8
Art. 05.101 □ 10



H.800 X L.160 mm.
Art. 05.104 □ 8
H.950 X L.160 mm.
Art. 05.105 □ 8



H.800 X L.110 mm.
Art. 05.106 □ 10



H.800 X L.200 mm.
Art. 05.107 □ 8



H.800 X L.260 mm.
Art. 05.108 □ 8



H.800 X L.140 mm.
Art. 05.109 □ 8
H.950 X L.140 mm.
Art. 05.110 □ 8



H.800 X L.200 mm.
Art. 05.111 □ 8
H.950 X L.200 mm.
Art. 05.112 □ 8



H.800 X L.140 mm.
Art. 05.113 □ 8
H.950 X L.140 mm.
Art. 05.114 □ 8



H.950 X L.240 mm.
Art. 05.115
□12 ≙ 12 X 6

Tutte le parti di questo catalogo - foto comprese - sono di proprietà Euro-Fer. La riproduzione, anche parziale, è vietata in ogni forma e con ogni mezzo. / Every part of this catalogue - photos included - is Euro-Fer's property. All forms of copying are strictly prohibited.



H.950 X L.160 mm.
Art. 05.116
□ 12 ≠ 12 X 6



H.820 X L.215 mm.
Art. 05.117 □ 8
H.950 X L.215 mm.
Art. 05.118 □ 8



H.820 X L.205 mm.
Art. 05.119 □ 8
H.950 X L.205 mm.
Art. 05.120 □ 8



Art. 05.121



Art. 05.122



Rigato / Fluted
H.950 x L.240 mm
Art. 05.122.50
□ 12 mm ≠ 12 x 6



Rigato / Fluted
H.950 x L.240 mm
Art. 05.122.51
□ 12 mm ≠ 12 x 6



Liscio / Smooth
H.950 mm
Art. 05.123 □ 12 mm
Art. 05.123.01 □ 14 mm
Art. 05.123.ES □ 12 mm
Art. 05.123.01.ES □ 14 mm
Art. 05.123.02 □ 16 mm
Art. 05.123.02.ES □ 16 mm

.ES = "Modello España"
.ES = "España Model"

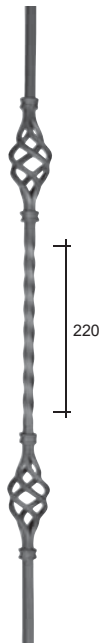

Liscio / Smooth
H.950 mm
Art. 05.124 □ 12 mm
Art. 05.124.01 □ 14 mm
Art. 05.124.ES □ 12 mm
Art. 05.124.01.ES □ 14 mm
Art. 05.124.06 □ 16 mm
Art. 05.124.06.ES □ 16 mm



Liscio / Smooth
H.950 mm
Art. 05.124.02 □ 12 mm
H.950 mm
Art. 05.124.03 □ 14 mm
H.950 mm
Art. 05.124.07 □ 16 mm



Liscio / Smooth
H.950 mm
Art. 05.124.04 □ 12 mm
H.950 mm
Art. 05.124.05 □ 14 mm
H.950 mm
Art. 05.124.08 □ 16 mm



H.950 X L.150 mm.
Art. 05.125
□ 12 ≠ 12 X 6



H.950 X L.150 mm.
Art. 05.126
□ 12 ≠ 12 X 6



H.950 X L.220 mm.
Art. 05.127
□ 12 ≠ 12 X 6

PANNELLI LISCI E PALETTI PER RECINZIONI
PLAIN PANEL UNITS AND STAKES FOR FENCES



H.950 X L.140 mm.
Art. 05.128
 □ 12 ≧ 12 X 6



H.950 X L.205 mm.
Art. 05.129
 □ 12 ≧ 12 X 6



H.950 X L.170 mm.
Art. 05.130
 □ 12 ≧ 12 X 6



H.950 X L.170 mm.
Art. 05.131
 □ 12 ≧ 12 X 6



H.950 X L.230 mm.
Art. 05.132
 □ 12 ≧ 12 X 6



H.950 X L.185 mm.
Art. 05.133
 □ 12 ≧ 12 X 6



H.950 X L.215 mm.
Art. 05.134
 □ 12 ≧ 12 X 6



H.950 X L.215 mm.
Art. 05.135
 □ 12 ≧ 12 X 6



H.950 X L.215 mm.
Art. 05.136
 □ 12 ≧ 12 X 6



Liscio / Smooth
 H.950 x L.235 mm
Art. 05.136.01
 □ 12 mm ≧ 12 x 6 mm



Tutte le parti di questo catalogo - foto comprese - sono di proprietà Euro-Fer. La riproduzione, anche parziale, è vietata in ogni forma e con ogni mezzo. / Every part of this catalogue - photos included - is Euro-Fer's property. All forms of copying are strictly prohibited.



H.950 X L.250 mm.
Art. 05.137
 □ 12 ≙ 12 X 6

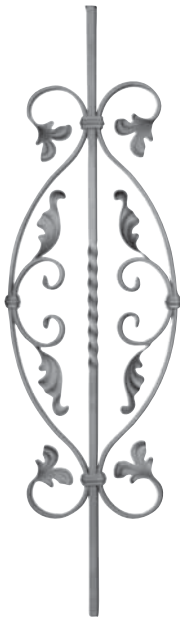

H.950 X L.250 mm.
Art. 05.138
 □ 12 ≙ 12 X 6



H.950 X L.170 mm.
Art. 05.139
 □ 12 ≙ 12 X 6



H.950 X L.170 mm.
Art. 05.140
 □ 12 ≙ 12 X 6



H.950 X L.260 mm.
Art. 05.141
 □ 12 ≙ 12 X 6
Art. 05.141.02
 □ 14 ≙ 14 X 6



H.950 X L.230 mm.
Art. 05.141.01
 □ 12 ≙ 12 X 6
Art. 05.141.03
 □ 14 ≙ 14 X 6



Liscio / Smooth
 H.950 x L.280 mm
Art. 05.141.04
 □ 12 ≙ 12 x 6



H.860 X L.350 mm.
Art. 05.142 ≙ 12 X 6
Art. 05.142.04 ≙ 14 X 6
Art. 05.142.05 ≙ 16 X 8
 Mod. Scala / *Scala Model*
Art. 05.142.06 ≙ 12 X 6
Art. 05.142.07 ≙ 14 X 6
Art. 05.142.08 ≙ 16 X 8



H.860 X L.350 mm.
Art. 05.142.01 ≙ 12 X 6
Art. 05.142.09 ≙ 14 X 6
Art. 05.142.10 ≙ 16 X 8
 Mod. Scala / *Scala Model*
Art. 05.142.11 ≙ 12 X 6
Art. 05.142.12 ≙ 14 X 6
Art. 05.142.13 ≙ 16 X 8



H.950 X L.175 mm.
Art. 05.142.02 □ 12
 H.950 X L.175 mm.
Art. 05.142.03 □ 14



Fuori Produzione
 Out of Production

Art. 05.143

PANNELLI LISCI E PALETTI PER RECINZIONI
PLAIN PANEL UNITS AND STAKES FOR FENCES

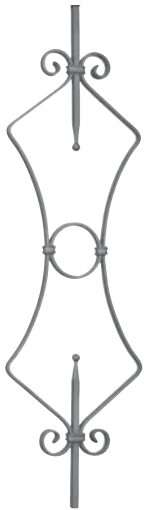

H.950 X L.260 mm.
Art. 05.144
 □ 12 ≧ 12 X 6



Art. 05.145



H.950 X L.260 mm.
Art. 05.146
 □ 12 ≧ 12 X 6



Art. 05.147



H.950 X L.290 mm.
Art. 05.148
 □ 12 ≧ 12 X 6



H.950 X L.205 mm.
Art. 05.149
 □ 12 ≧ 12 X 6



H.950 X L.140 mm.
Art. 05.149.01
 □ 12 ≧ 12 X 6



H.950 X L.190 mm.
Art. 05.150
 □ 12 ≧ 12 X 6



H.950 X L.145 mm.
Art. 05.150.01
 □ 12 ≧ 12 X 6
Art. 05.150.02
 □ 14 ≧ 14 X 6



H.950 X L.95 mm.
Art. 05.151
 □ 12 ≧ 12 X 6



H.950 X L.210 mm.
Art. 05.152
 □ 12 ≧ 12 X 6



H.950 X L.150 mm.
Art. 05.152.01 □ 8



H.950 X L.205 mm.
Art. 05.153
 □ 12 ≧ 12 X 6

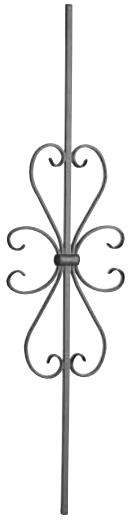

H.950 X L.225 mm.
Art. 05.153.01
 □ 12 ≧ 12 X 6



H.950 X L.220 mm.
Art. 05.154
 □ 12 ≧ 12 X 6



H.950 X L.230 mm.
Art. 05.154.01
 □ 12 ≧ 12 X 6
Art. 05.154.08
 □ 14 ≧ 14 X 6



H.950 X L.185 mm.
Art. 05.154.02
 □ 14 ≧ 14 X 6



H.950 X L.200 mm.
Art. 05.154.03
 □ 12 ≧ 12 X 6
Art. 05.154.09
 □ 14 ≧ 14 X 6



H.950 X L.220 mm.
Art. 05.154.04
 □ 12 ≧ 12 X 6
Art. 05.154.10
 □ 16 ≧ 16 X 8



H.950 X L.205 mm.
Art. 05.154.05
 □ 12 ≧ 12 X 6
Art. 05.154.11
 □ 16 ≧ 16 X 8



H.950 X L.245 mm.
Art. 05.154.06
 □ 12 ≧ 12 X 6

Tutte le parti di questo catalogo - foto comprese - sono di proprietà Euro-Fer. La riproduzione, anche parziale, è vietata in ogni forma e con ogni mezzo. / Every part of this catalogue - photos included - is Euro-Fer's property. All forms of copying are strictly prohibited.



H.830 X L.280 mm.
Art. 05.154.07
≠ 16 X 6

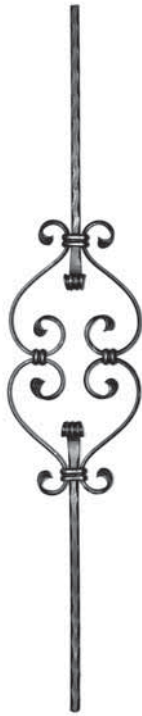

Martellato / *Hammered*
H.950 x L.170 mm
Art. 05.154.12
□ 12 ≠ 12 x 6 mm



Rigato / *Fluted*
H.950 x L.240 mm
Art. 05.154.13
≠ 16 x 8 mm



Rigato / *Fluted*
H.950 x L.360 mm
Art. 05.154.14
□ 16 ≠ 16 x 8 mm



Art. 05.154.15



Liscio / *Smooth*
H.900 x L.275 mm
Art. 05.154.16
≠ 20 x 6 mm



Rigato / *Fluted*
H.950 x L.190 mm
Art. 05.154.17
≠ 16 x 8 mm



Martellato / *Hammered*
H.950 x L.230 mm
Art. 05.154.18
≠ 16 x 8 mm



Martellato / *Hammered*
H.950 x L.230 mm
Art. 05.154.19
≠ 16 x 8 mm



Liscio / *Smooth*
H.950 x L.180 mm
Art. 05.154.20 □ 12 mm
Con fiori su ambo i lati /
Flowers on both sides



Liscio / *Smooth*
H.950 mm
Art. 05.154.100 □ 12 mm
Art. 05.154.101 □ 14 mm
Art. 05.154.102 □ 16 mm
Art. 05.154.103 □ 18 mm
Art. 05.154.104 □ 20 mm



Liscio / *Smooth*
H.950 mm
Art. 05.154.200 Ø 12 mm
Art. 05.154.201 Ø 14 mm
Art. 05.154.202 Ø 16 mm
Art. 05.154.203 Ø 18 mm
Art. 05.154.204 Ø 20 mm

PANNELLI LISCI E PALETTI PER RECINZIONI
PLAIN PANEL UNITS AND STAKES FOR FENCES

← Punta a matita /
Pencil Point

← Punta a piramide →
Pyramid Point

Tondo / Round

H.950 mm.

- Art. 05.155 Ø 12
- Art. 05.156 Ø 14
- Art. 05.157 Ø 16
- Art. 05.158 Ø 18
- Art. 05.159 Ø 20

H.1000 mm.

- Art. 05.160 Ø 12
- Art. 05.161 Ø 14
- Art. 05.162 Ø 16
- Art. 05.163 Ø 18
- Art. 05.164 Ø 20

H.1200 mm.

- Art. 05.165 Ø 12
- Art. 05.166 Ø 14
- Art. 05.167 Ø 16
- Art. 05.168 Ø 18
- Art. 05.169 Ø 20

H.1500 mm.

- Art. 05.170 Ø 12
- Art. 05.171 Ø 14
- Art. 05.172 Ø 16
- Art. 05.173 Ø 18
- Art. 05.174 Ø 20

H.950 mm.

- | | |
|------------------|------------------|
| Art. 05.175 □ 12 | Art. 05.193 □ 12 |
| Art. 05.176 □ 14 | Art. 05.194 □ 14 |
| Art. 05.177 □ 16 | Art. 05.195 □ 16 |
| Art. 05.178 □ 18 | Art. 05.196 □ 18 |
| Art. 05.179 □ 20 | Art. 05.197 □ 20 |
| Art. 05.180 □ 25 | Art. 05.198 □ 25 |
| Art. 05.181 □ 30 | Art. 05.199 □ 30 |
| Art. 05.182 □ 35 | Art. 05.200 □ 35 |
| Art. 05.183 □ 40 | Art. 05.201 □ 40 |

H.1200 mm.

- | | |
|------------------|------------------|
| Art. 05.175 □ 12 | Art. 05.193 □ 12 |
| Art. 05.176 □ 14 | Art. 05.194 □ 14 |
| Art. 05.177 □ 16 | Art. 05.195 □ 16 |
| Art. 05.178 □ 18 | Art. 05.196 □ 18 |
| Art. 05.179 □ 20 | Art. 05.197 □ 20 |
| Art. 05.180 □ 25 | Art. 05.198 □ 25 |
| Art. 05.181 □ 30 | Art. 05.199 □ 30 |
| Art. 05.182 □ 35 | Art. 05.200 □ 35 |
| Art. 05.183 □ 40 | Art. 05.201 □ 40 |

H.1000 mm.

- | | |
|------------------|------------------|
| Art. 05.184 □ 12 | Art. 05.202 □ 12 |
| Art. 05.185 □ 14 | Art. 05.203 □ 14 |
| Art. 05.186 □ 16 | Art. 05.204 □ 16 |
| Art. 05.187 □ 18 | Art. 05.205 □ 18 |
| Art. 05.188 □ 20 | Art. 05.206 □ 20 |
| Art. 05.189 □ 25 | Art. 05.207 □ 25 |
| Art. 05.190 □ 30 | Art. 05.208 □ 30 |
| Art. 05.191 □ 35 | Art. 05.209 □ 35 |
| Art. 05.192 □ 40 | Art. 05.210 □ 40 |

H.1500 mm.

- | | |
|------------------|------------------|
| Art. 05.184 □ 12 | Art. 05.202 □ 12 |
| Art. 05.185 □ 14 | Art. 05.203 □ 14 |
| Art. 05.186 □ 16 | Art. 05.204 □ 16 |
| Art. 05.187 □ 18 | Art. 05.205 □ 18 |
| Art. 05.188 □ 20 | Art. 05.206 □ 20 |
| Art. 05.189 □ 25 | Art. 05.207 □ 25 |
| Art. 05.190 □ 30 | Art. 05.208 □ 30 |
| Art. 05.191 □ 35 | Art. 05.209 □ 35 |
| Art. 05.192 □ 40 | Art. 05.210 □ 40 |

Martellato / Hammered

H.950 mm.

- Art. 05.211 □ 12
- Art. 05.212 □ 14
- Art. 05.213 □ 16
- Art. 05.214 □ 18
- Art. 05.215 □ 20

H.1000 mm.

- Art. 05.216 □ 12
- Art. 05.217 □ 14
- Art. 05.218 □ 16
- Art. 05.219 □ 18
- Art. 05.220 □ 20

H.1200 mm.

- Art. 05.221 □ 12
- Art. 05.222 □ 14
- Art. 05.223 □ 16
- Art. 05.224 □ 18
- Art. 05.225 □ 20

H.1500 mm.

- Art. 05.226 □ 12
- Art. 05.227 □ 14
- Art. 05.228 □ 16
- Art. 05.229 □ 18
- Art. 05.230 □ 20

Tubo / Tube

H.900 x L.140 mm

Art. 05.229.01 Ø 20 mm

H.1150 x L.140 mm

Art. 05.229.02 Ø 20 mm

H.1475 x L.140 mm

Art. 05.229.03 Ø 20 mm

H.1800 x L.140 mm

Art. 05.229.04 Ø 20 mm

Pieno / Solid

H.1000 X L.124 mm.

Art. 05.230.01 Ø 12

H.1000 X L.128 mm.

Art. 05.230.02 Ø 14

H.1000 X L.124 mm.

Art. 05.230.03 □ 12

H.1000 X L.128 mm.

Art. 05.230.04 □ 14

206

Pieno / Solid

H.1000 X L.230 mm.

Art. 05.230.05 □ 12

H.1000 X L.234 mm.

Art. 05.230.06 □ 14

H.1000 X L.230 mm.

Art. 05.230.07 Ø 12

H.1000 X L.234 mm.

Art. 05.230.08 Ø 14

Palline Grandi / Large Balls

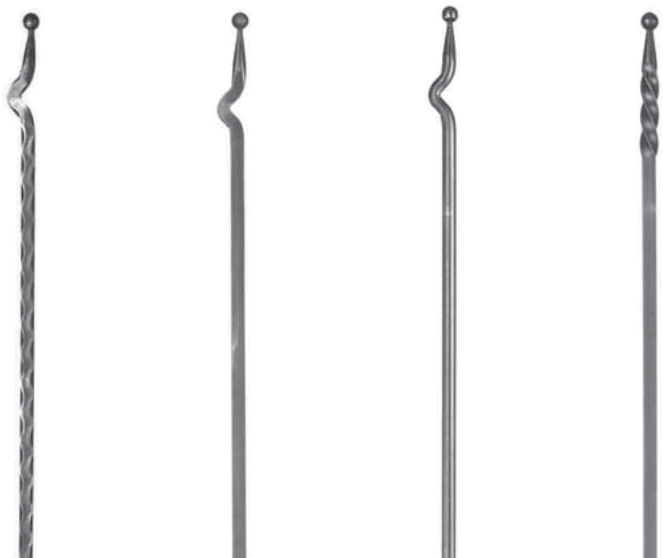

Martellato / Hammered

H.950 mm.

- Art. 05.230.09 □ 12
- Art. 05.230.10 □ 14
- Art. 05.230.11 □ 16
- Art. 05.230.12 □ 18

H.1000 mm.

- Art. 05.230.13 □ 12
- Art. 05.230.14 □ 14
- Art. 05.230.15 □ 16
- Art. 05.230.16 □ 18

H.1200 mm.

- Art. 05.230.17 □ 12
- Art. 05.230.18 □ 14
- Art. 05.230.19 □ 16
- Art. 05.230.20 □ 18

H.1500 mm.

- Art. 05.230.21 □ 12
- Art. 05.230.22 □ 14
- Art. 05.230.23 □ 16
- Art. 05.230.24 □ 18

H.950 mm.

- Art. 05.230.25 □ 12
- Art. 05.230.26 □ 14
- Art. 05.230.27 □ 16
- Art. 05.230.28 □ 18

H.1000 mm.

- Art. 05.230.29 □ 12
- Art. 05.230.30 □ 14
- Art. 05.230.31 □ 16
- Art. 05.230.32 □ 18

H.1200 mm.

- Art. 05.230.33 □ 12
- Art. 05.230.34 □ 14
- Art. 05.230.35 □ 16
- Art. 05.230.36 □ 18

H.1500 mm.

- Art. 05.230.37 □ 12
- Art. 05.230.38 □ 14
- Art. 05.230.39 □ 16
- Art. 05.230.40 □ 18

Tondo / Round

H.950 mm.

- Art. 05.230.41 Ø12
- Art. 05.230.42 Ø14
- Art. 05.230.43 Ø16
- Art. 05.230.44 Ø18

H.1000 mm.

- Art. 05.230.45 Ø12
- Art. 05.230.46 Ø14
- Art. 05.230.47 Ø16
- Art. 05.230.48 Ø18

H.1200 mm.

- Art. 05.230.49 Ø12
- Art. 05.230.50 Ø14
- Art. 05.230.51 Ø16
- Art. 05.230.52 Ø18

H.1500 mm.

- Art. 05.230.53 Ø12
- Art. 05.230.54 Ø14
- Art. 05.230.55 Ø16
- Art. 05.230.56 Ø18

H.950 mm.

- Art. 05.230.57 □ 12
- Art. 05.230.58 □ 14
- Art. 05.230.59 □ 16
- Art. 05.230.60 □ 18

H.1000 mm.

- Art. 05.230.61 □ 12
- Art. 05.230.62 □ 14
- Art. 05.230.63 □ 16
- Art. 05.230.64 □ 18

H.1200 mm.

- Art. 05.230.65 □ 12
- Art. 05.230.66 □ 14
- Art. 05.230.67 □ 16
- Art. 05.230.68 □ 18

H.1500 mm.

- Art. 05.230.69 □ 12
- Art. 05.230.70 □ 14
- Art. 05.230.71 □ 16
- Art. 05.230.72 □ 18





Fascetta inserita a caldo / Hot-inserted clip



Martellato / Hammered

H.950 mm.	
Art. 05.230.73	□ 14
Art. 05.230.74	□ 16
H.1000 mm.	
Art. 05.230.75	□ 14
Art. 05.230.76	□ 16
H.1200 mm.	
Art. 05.230.77	□ 14
Art. 05.230.78	□ 16
H.1500 mm.	
Art. 05.230.79	□ 14
Art. 05.230.80	□ 16
H.2000 mm.	
Art. 05.230.81	□ 14
Art. 05.230.82	□ 16

H.950 mm.	
Art. 05.230.83	□ 14
Art. 05.230.84	□ 16
H.1000 mm.	
Art. 05.230.85	□ 14
Art. 05.230.86	□ 16
H.1200 mm.	
Art. 05.230.87	□ 14
Art. 05.230.88	□ 16
H.1500 mm.	
Art. 05.230.89	□ 14
Art. 05.230.90	□ 16
H.2000 mm.	
Art. 05.230.91	□ 14
Art. 05.230.92	□ 16

Tondo / Round

H.950 mm.	
Art. 05.230.93	Ø14
Art. 05.230.94	Ø16
H.1000 mm.	
Art. 05.230.95	Ø14
Art. 05.230.96	Ø16
H.1200 mm.	
Art. 05.230.97	Ø14
Art. 05.230.98	Ø16
H.1500 mm.	
Art. 05.230.99	Ø14
Art. 05.230.100	Ø16
H.2000 mm.	
Art. 05.230.101	Ø14
Art. 05.230.102	Ø16

Martellato / Hammered

H.950 mm.	
Art. 05.230.103	□ 14
Art. 05.230.104	□ 16
H.1000 mm.	
Art. 05.230.105	□ 14
Art. 05.230.106	□ 16
H.1200 mm.	
Art. 05.230.107	□ 14
Art. 05.230.108	□ 16
H.1500 mm.	
Art. 05.230.109	□ 14
Art. 05.230.110	□ 16
H.2000 mm.	
Art. 05.230.111	□ 14
Art. 05.230.112	□ 16

H.950 mm.	
Art. 05.230.113	□ 14
Art. 05.230.114	□ 16
H.1000 mm.	
Art. 05.230.115	□ 14
Art. 05.230.116	□ 16
H.1200 mm.	
Art. 05.230.117	□ 14
Art. 05.230.118	□ 16
H.1500 mm.	
Art. 05.230.119	□ 14
Art. 05.230.120	□ 16
H.2000 mm.	
Art. 05.230.121	□ 14
Art. 05.230.122	□ 16

Tondo / Round

H.950 mm.	
Art. 05.230.123	Ø14
Art. 05.230.124	Ø16
H.1000 mm.	
Art. 05.230.125	Ø14
Art. 05.230.126	Ø16
H.1200 mm.	
Art. 05.230.127	Ø14
Art. 05.230.128	Ø16
H.1500 mm.	
Art. 05.230.129	Ø14
Art. 05.230.130	Ø16
H.2000 mm.	
Art. 05.230.131	Ø14
Art. 05.230.132	Ø16



Martellato / Hammered

H.1000 mm.	
Art. 05.230.133	□ 14
Art. 05.230.134	□ 16
Art. 05.230.135	□ 18
H.1200 mm.	
Art. 05.230.136	□ 14
Art. 05.230.137	□ 16
Art. 05.230.138	□ 18
H.1500 mm.	
Art. 05.230.139	□ 14
Art. 05.230.140	□ 16
Art. 05.230.141	□ 18

H.1000 mm.	
Art. 05.230.142	□ 14
Art. 05.230.143	□ 16
Art. 05.230.144	□ 18
H.1200 mm.	
Art. 05.230.145	□ 14
Art. 05.230.146	□ 16
Art. 05.230.147	□ 18
H.1500 mm.	
Art. 05.230.148	□ 14
Art. 05.230.149	□ 16
Art. 05.230.150	□ 18

Tondo / Round

H.1000 mm.	
Art. 05.230.151	Ø14
Art. 05.230.152	Ø16
Art. 05.230.153	Ø18
H.1200 mm.	
Art. 05.230.154	Ø14
Art. 05.230.155	Ø16
Art. 05.230.156	Ø18
H.1500 mm.	
Art. 05.230.157	Ø14
Art. 05.230.158	Ø16
Art. 05.230.159	Ø18

Tondo Lavorato
Worked Round Bar

H.1000 mm.	
Art. 05.230.160	Ø14
Art. 05.230.161	Ø16
Art. 05.230.162	Ø18
H.1200 mm.	
Art. 05.230.163	Ø14
Art. 05.230.164	Ø16
Art. 05.230.165	Ø18
H.1500 mm.	
Art. 05.230.166	Ø14
Art. 05.230.167	Ø16
Art. 05.230.168	Ø18

Liscio / Smooth
H.950 x L.120 mm
Art. 05.230.169 □ 12

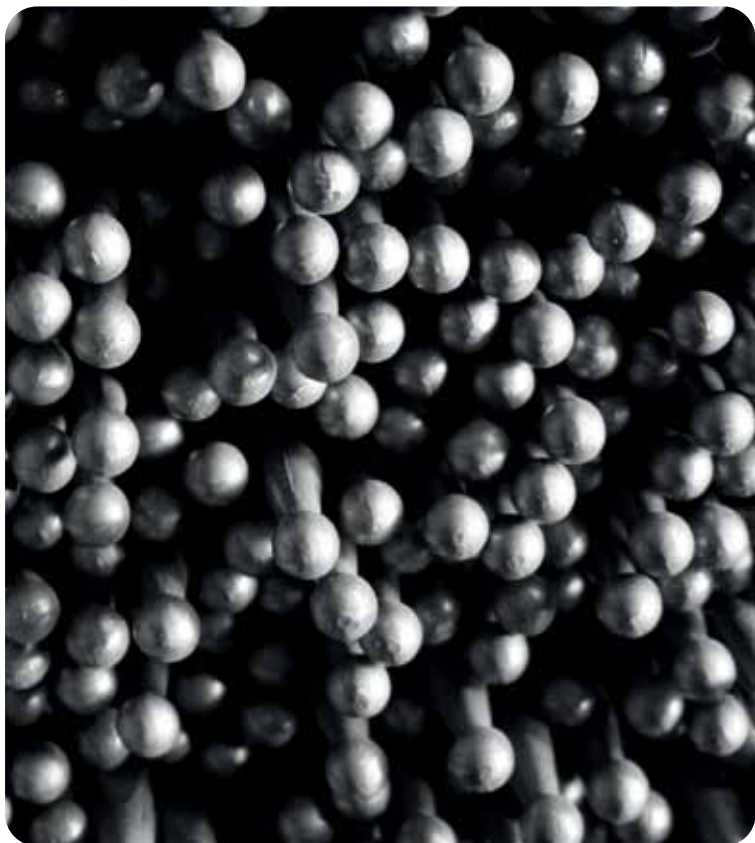



<p>Tondo / Round H.950 mm.</p> <p>Art. 05.231 Ø12 Art. 05.232 Ø14 Art. 05.233 Ø16 Art. 05.234 Ø18 Art. 05.235 Ø20</p> <p>H.1000 mm.</p> <p>Art. 05.236 Ø12 Art. 05.237 Ø14 Art. 05.238 Ø16 Art. 05.239 Ø18 Art. 05.240 Ø20</p> <p>H.1200 mm.</p> <p>Art. 05.241 Ø12 Art. 05.242 Ø14 Art. 05.243 Ø16 Art. 05.244 Ø18 Art. 05.245 Ø20</p> <p>H.1500 mm.</p> <p>Art. 05.246 Ø12 Art. 05.247 Ø14 Art. 05.248 Ø16 Art. 05.249 Ø18 Art. 05.250 Ø20</p>	<p>Tondo / Round H.950 mm.</p> <p>Art. 05.231.01 Ø12 Art. 05.232.01 Ø14 Art. 05.233.01 Ø16</p> <p>H.1000 mm.</p> <p>Art. 05.236.01 Ø12 Art. 05.237.01 Ø14 Art. 05.238.01 Ø16</p> <p>H.1200 mm.</p> <p>Art. 05.241.01 Ø12 Art. 05.242.01 Ø14 Art. 05.243.01 Ø16 Art. 05.245.01 Ø20</p> <p>H.1500 mm.</p> <p>Art. 05.246.01 Ø12 Art. 05.247.01 Ø14 Art. 05.248.01 Ø16</p>
--	---

<p>Fiamma grande / Big flame</p> <p>H.950 mm.</p> <p>Art. 05.251 □ 12 Art. 05.252 □ 14 Art. 05.253 □ 16 Art. 05.254 □ 18 Art. 05.255 □ 20</p> <p>H.1000 mm.</p> <p>Art. 05.256 □ 12 Art. 05.257 □ 14 Art. 05.258 □ 16 Art. 05.259 □ 18 Art. 05.260 □ 20</p> <p>H.1200 mm.</p> <p>Art. 05.261 □ 12 Art. 05.262 □ 14 Art. 05.263 □ 16 Art. 05.264 □ 18 Art. 05.265 □ 20</p> <p>H.1500 mm.</p> <p>Art. 05.266 □ 12 Art. 05.267 □ 14 Art. 05.268 □ 16 Art. 05.269 □ 18 Art. 05.270 □ 20</p>	<p>Fiamma grande / Big flame</p> <p>Liscio / Smooth H.950 mm</p> <p>Art. 05.251.02 □ 12 Art. 05.252.02 □ 14 Art. 05.253.02 □ 16 Art. 05.254.02 □ 18 Art. 05.255.02 □ 20</p> <p>H.1000 mm</p> <p>Art. 05.256.02 □ 12 Art. 05.257.02 □ 14 Art. 05.258.02 □ 16 Art. 05.259.02 □ 18 Art. 05.260.02 □ 20</p> <p>H.1200 mm</p> <p>Art. 05.261.02 □ 12 Art. 05.262.02 □ 14 Art. 05.263.02 □ 16 Art. 05.264.02 □ 18 Art. 05.265.02 □ 20</p> <p>H.1500 mm</p> <p>Art. 05.266.02 □ 12 Art. 05.267.02 □ 14 Art. 05.268.02 □ 16 Art. 05.269.02 □ 18 Art. 05.270.02 □ 20</p>	<p>Fiamma grande / Big flame</p> <p>Liscio / Smooth H.950 mm</p> <p>Art. 05.268.50 □ 12 Art. 05.268.51 □ 14 Art. 05.268.52 □ 16 Art. 05.268.53 Ø 12 Art. 05.268.54 Ø 14 Art. 05.268.55 Ø 16</p> <p>H.1000 mm</p> <p>Art. 05.268.56 □ 12 Art. 05.268.57 □ 14 Art. 05.268.58 □ 16 Art. 05.268.59 Ø 12 Art. 05.268.60 Ø 14 Art. 05.268.61 Ø 16</p> <p>H.1200 mm</p> <p>Art. 05.268.62 □ 12 Art. 05.268.63 □ 14 Art. 05.268.64 □ 16 Art. 05.268.65 Ø 12 Art. 05.268.66 Ø 14 Art. 05.268.67 Ø 16</p> <p>H.1500 mm</p> <p>Art. 05.268.68 □ 12 Art. 05.268.69 □ 14 Art. 05.268.70 □ 16 Art. 05.268.71 Ø 12 Art. 05.268.72 Ø 14 Art. 05.268.73 Ø 16</p>	<p>Martellato / Hammered H.950 mm.</p> <p>Art. 05.271 □ 12 Art. 05.272 □ 14 Art. 05.273 □ 16 Art. 05.274 □ 18 Art. 05.275 □ 20</p> <p>H.1000 mm.</p> <p>Art. 05.276 □ 12 Art. 05.277 □ 14 Art. 05.278 □ 16 Art. 05.279 □ 18 Art. 05.280 □ 20</p> <p>H.1200 mm.</p> <p>Art. 05.281 □ 12 Art. 05.282 □ 14 Art. 05.283 □ 16 Art. 05.284 □ 18 Art. 05.285 □ 20</p> <p>H.1500 mm.</p> <p>Art. 05.286 □ 12 Art. 05.287 □ 14 Art. 05.288 □ 16 Art. 05.289 □ 18 Art. 05.290 □ 20</p>	<p>Fiamma grande / Big flame</p> <p>Martellato / Hammered H.950 mm</p> <p>Art. 05.271.02 □ 12 Art. 05.272.02 □ 14 Art. 05.273.02 □ 16 Art. 05.276.02 □ 12 Art. 05.277.02 □ 14 Art. 05.278.02 □ 16 Art. 05.281.02 □ 12 Art. 05.282.02 □ 14 Art. 05.283.02 □ 16 Art. 05.286.02 □ 12 Art. 05.287.02 □ 14 Art. 05.288.02 □ 16</p> <p>H.1000 mm</p> <p>Art. 05.271.02 □ 12 Art. 05.272.02 □ 14 Art. 05.273.02 □ 16</p> <p>H.1200 mm</p> <p>Art. 05.276.02 □ 12 Art. 05.277.02 □ 14 Art. 05.278.02 □ 16</p> <p>H.1500 mm</p> <p>Art. 05.281.02 □ 12 Art. 05.282.02 □ 14 Art. 05.283.02 □ 16 Art. 05.286.02 □ 12 Art. 05.287.02 □ 14 Art. 05.288.02 □ 16</p>
---	---	---	--	---

Tutte le parti di questo catalogo - foto comprese - sono di proprietà Euro-Fer. La riproduzione, anche parziale, è vietata in ogni forma e con ogni mezzo. / Every part of this catalogue - photos included - is Euro-Fer's property. All forms of copying are strictly prohibited.



Schiacciata sullo spigolo /
Ornament on the edge

Liscio / Smooth

H.950 mm

- Art. 05.289.01 12
Art. 05.289.02 14
Art. 05.289.03 16

H.1000 mm

- Art. 05.289.04 12
Art. 05.289.05 14
Art. 05.289.06 16

H.1200 mm

- Art. 05.289.07 12
Art. 05.289.08 14
Art. 05.289.09 16

H.1500 mm

- Art. 05.289.10 12
Art. 05.289.11 14
Art. 05.289.12 16



Martellato / Hammered

H.950 mm

- Art. 05.290.01 12
Art. 05.290.02 14
Art. 05.290.03 16

H.1000 mm

- Art. 05.290.04 12
Art. 05.290.05 14
Art. 05.290.06 16

H.1200 mm

- Art. 05.290.07 12
Art. 05.290.08 14
Art. 05.290.09 16

H.1500 mm

- Art. 05.290.10 12
Art. 05.290.11 14
Art. 05.290.12 16



Liscio / Smooth

H.950 mm

- Art. 05.290.13 12
Art. 05.290.14 14
Art. 05.290.15 16

H.1000 mm

- Art. 05.290.16 12
Art. 05.290.17 14
Art. 05.290.18 16

H.1200 mm

- Art. 05.290.19 12
Art. 05.290.20 14
Art. 05.290.21 16

H.1500 mm

- Art. 05.290.22 12
Art. 05.290.23 14
Art. 05.290.24 16



H.950 mm.

- Art. 05.291 12
Art. 05.292 14
Art. 05.293 16

H.1000 mm.

- Art. 05.294 12
Art. 05.295 14
Art. 05.296 16

H.1200 mm.

- Art. 05.297 12
Art. 05.298 14
Art. 05.299 16

H.1500 mm.

- Art. 05.300 12
Art. 05.301 14
Art. 05.302 16



H.950 mm.

- Art. 05.303 12
Art. 05.304 14
Art. 05.305 16
Art. 05.306 18
Art. 05.307 20

H.1000 mm.

- Art. 05.308 12
Art. 05.309 14
Art. 05.310 16
Art. 05.311 18
Art. 05.312 20

H.1200 mm.

- Art. 05.313 12
Art. 05.314 14
Art. 05.315 16
Art. 05.316 18
Art. 05.317 20

H.1500 mm.

- Art. 05.318 12
Art. 05.319 14
Art. 05.320 16
Art. 05.321 18
Art. 05.322 20



H.950 mm.

- Art. 05.323 12
Art. 05.324 14
Art. 05.325 16
Art. 05.326 18
Art. 05.327 20

H.1000 mm.

- Art. 05.328 12
Art. 05.329 14
Art. 05.330 16
Art. 05.331 18
Art. 05.332 20

H.1200 mm.

- Art. 05.333 12
Art. 05.334 14
Art. 05.335 16
Art. 05.336 18
Art. 05.337 20

H.1500 mm.

- Art. 05.338 12
Art. 05.339 14
Art. 05.340 16
Art. 05.341 18
Art. 05.342 20



Liscio / Smooth

H.950 mm

- Art. 05.342.20 12
Art. 05.342.21 14

H.1000 mm

- Art. 05.342.22 12
Art. 05.342.23 14

H.1200 mm

- Art. 05.342.24 12
Art. 05.342.25 14

H.1500 mm

- Art. 05.342.26 12
Art. 05.342.27 14



Liscio

≠ 25 x 8 mm

- Art. 05.342.100 H.950
Art. 05.342.101 H.1000
Art. 05.342.102 H.1200
Art. 05.342.103 H.1500

Liscio

≠ 30 x 8 mm

- Art. 05.342.104 H.950
Art. 05.342.105 H.1000
Art. 05.342.106 H.1200
Art. 05.342.107 H.1500



Martellato / Hammered

H.950 mm.

- Art. 05.343 12
Art. 05.344 14

H.1000 mm.

- Art. 05.345 12
Art. 05.346 14

H.1200 mm.

- Art. 05.347 12
Art. 05.348 14

H.1500 mm.

- Art. 05.349 12
Art. 05.350 14



Liscio / Smooth
H 950 mm

- Art. 05.350.100 Ø12
Art. 05.350.101 Ø14

H 1000 mm

- Art. 05.350.103 Ø12
Art. 05.350.104 Ø14



Liscio / Smooth

H 950 mm

- Art. 05.350.125 12
Art. 05.350.126 14
Art. 05.350.127 16

H 1000 mm

- Art. 05.350.130 12
Art. 05.350.131 14
Art. 05.350.132 16

PALLINE PICCOLE /
SMALL BALLS



PALLINE GRANDI /
LARGE BALLS

PALLINE GRANDI / LARGE BALLS

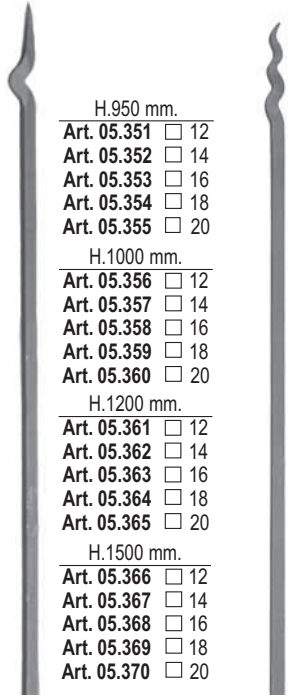

- | | |
|-------------|------|
| H.950 mm. | |
| Art. 05.351 | □ 12 |
| Art. 05.352 | □ 14 |
| Art. 05.353 | □ 16 |
| Art. 05.354 | □ 18 |
| Art. 05.355 | □ 20 |
| H.1000 mm. | |
| Art. 05.356 | □ 12 |
| Art. 05.357 | □ 14 |
| Art. 05.358 | □ 16 |
| Art. 05.359 | □ 18 |
| Art. 05.360 | □ 20 |
| H.1200 mm. | |
| Art. 05.361 | □ 12 |
| Art. 05.362 | □ 14 |
| Art. 05.363 | □ 16 |
| Art. 05.364 | □ 18 |
| Art. 05.365 | □ 20 |
| H.1500 mm. | |
| Art. 05.366 | □ 12 |
| Art. 05.367 | □ 14 |
| Art. 05.368 | □ 16 |
| Art. 05.369 | □ 18 |
| Art. 05.370 | □ 20 |

- | | |
|-------------|------|
| H.950 mm. | |
| Art. 05.371 | □ 12 |
| Art. 05.372 | □ 14 |
| Art. 05.373 | □ 16 |
| Art. 05.374 | □ 18 |
| Art. 05.375 | □ 20 |
| H.1000 mm. | |
| Art. 05.376 | □ 12 |
| Art. 05.377 | □ 14 |
| Art. 05.378 | □ 16 |
| Art. 05.379 | □ 18 |
| Art. 05.380 | □ 20 |
| H.1200 mm. | |
| Art. 05.381 | □ 12 |
| Art. 05.382 | □ 14 |
| Art. 05.383 | □ 16 |
| Art. 05.384 | □ 18 |
| Art. 05.385 | □ 20 |
| H.1500 mm. | |
| Art. 05.386 | □ 12 |
| Art. 05.387 | □ 14 |
| Art. 05.388 | □ 16 |
| Art. 05.389 | □ 18 |
| Art. 05.390 | □ 20 |

- Martellato / Hammered
- | | |
|----------------|------|
| H.950 mm. | |
| Art. 05.390.01 | □ 12 |
| Art. 05.390.02 | □ 14 |
| H.1000 mm. | |
| Art. 05.390.03 | □ 12 |
| Art. 05.390.04 | □ 14 |
| H.1200 mm. | |
| Art. 05.390.05 | □ 12 |
| Art. 05.390.06 | □ 14 |
| H.1500 mm. | |
| Art. 05.390.07 | □ 12 |
| Art. 05.390.08 | □ 14 |

- Martellato / Hammered
- | | |
|----------------|------|
| H.950 mm. | |
| Art. 05.390.09 | □ 12 |
| Art. 05.390.10 | □ 14 |
| H.1000 mm. | |
| Art. 05.390.11 | □ 12 |
| Art. 05.390.12 | □ 14 |
| H.1200 mm. | |
| Art. 05.390.13 | □ 12 |
| Art. 05.390.14 | □ 14 |
| H.1500 mm. | |
| Art. 05.390.15 | □ 12 |
| Art. 05.390.16 | □ 14 |

- | | |
|-------------|------|
| H.950 mm. | |
| Art. 05.399 | □ 12 |
| Art. 05.400 | □ 14 |
| H.1000 mm. | |
| Art. 05.401 | □ 12 |
| Art. 05.402 | □ 14 |
| H.1200 mm. | |
| Art. 05.403 | □ 12 |
| Art. 05.404 | □ 14 |
| H.1500 mm. | |
| Art. 05.405 | □ 12 |
| Art. 05.406 | □ 14 |

- | | |
|-------------|------|
| H.950 mm. | |
| Art. 05.407 | □ 12 |
| Art. 05.408 | □ 14 |
| H.1000 mm. | |
| Art. 05.409 | □ 12 |
| Art. 05.410 | □ 14 |
| H.1200 mm. | |
| Art. 05.411 | □ 12 |
| Art. 05.412 | □ 14 |
| H.1500 mm. | |
| Art. 05.413 | □ 12 |
| Art. 05.414 | □ 14 |

- Tondo / Round
- | | |
|----------------|-----|
| H.950 mm. | |
| Art. 05.414.01 | Ø12 |
| Art. 05.414.02 | Ø14 |
| Art. 05.414.03 | Ø16 |
| H.1000 mm. | |
| Art. 05.414.04 | Ø12 |
| Art. 05.414.05 | Ø14 |
| Art. 05.414.06 | Ø16 |
| H.1200 mm. | |
| Art. 05.414.07 | Ø12 |
| Art. 05.414.08 | Ø14 |
| Art. 05.414.09 | Ø16 |
| H.1500 mm. | |
| Art. 05.414.10 | Ø12 |
| Art. 05.414.11 | Ø14 |
| Art. 05.414.12 | Ø16 |

PALLINE GRANDI / LARGE BALLS

PALLINE PICCOLE / SMALL BALLS

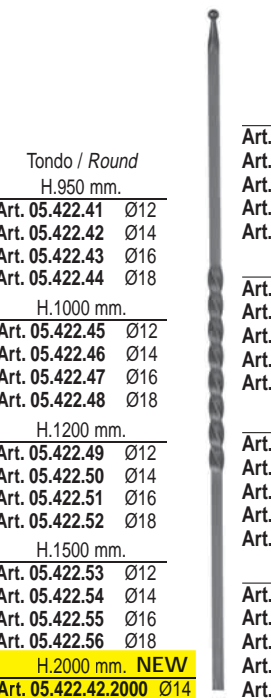
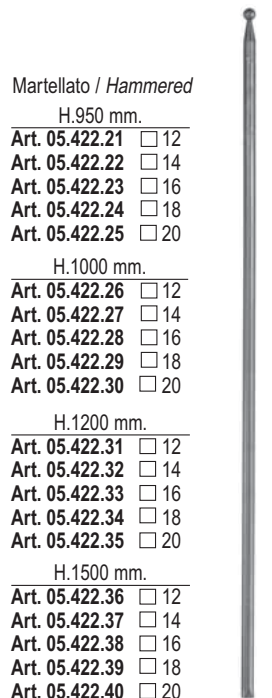
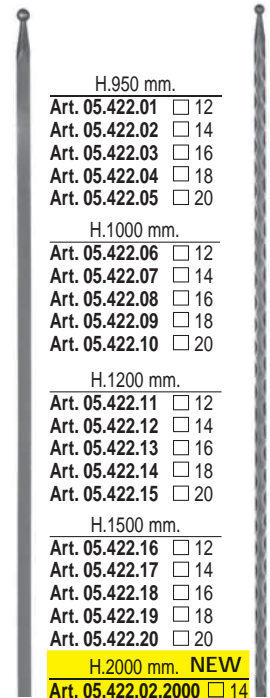
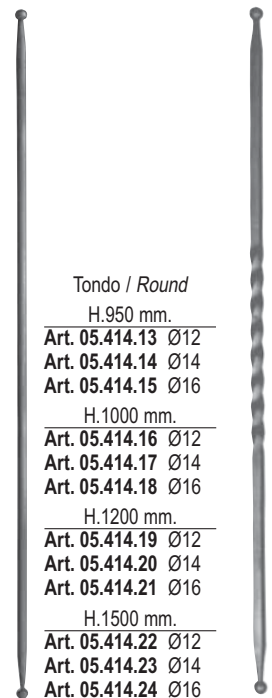

- Tondo / Round
- | | |
|----------------|-----|
| H.950 mm. | |
| Art. 05.414.13 | Ø12 |
| Art. 05.414.14 | Ø14 |
| Art. 05.414.15 | Ø16 |
| H.1000 mm. | |
| Art. 05.414.16 | Ø12 |
| Art. 05.414.17 | Ø14 |
| Art. 05.414.18 | Ø16 |
| H.1200 mm. | |
| Art. 05.414.19 | Ø12 |
| Art. 05.414.20 | Ø14 |
| Art. 05.414.21 | Ø16 |
| H.1500 mm. | |
| Art. 05.414.22 | Ø12 |
| Art. 05.414.23 | Ø14 |
| Art. 05.414.24 | Ø16 |

- | | |
|-------------|------|
| H.950 mm. | |
| Art. 05.415 | □ 12 |
| Art. 05.416 | □ 14 |
| H.1000 mm. | |
| Art. 05.417 | □ 12 |
| Art. 05.418 | □ 14 |
| H.1200 mm. | |
| Art. 05.419 | □ 12 |
| Art. 05.420 | □ 14 |
| H.1500 mm. | |
| Art. 05.421 | □ 12 |
| Art. 05.422 | □ 14 |

- | | |
|---------------------|------|
| H.950 mm. | |
| Art. 05.422.01 | □ 12 |
| Art. 05.422.02 | □ 14 |
| Art. 05.422.03 | □ 16 |
| Art. 05.422.04 | □ 18 |
| Art. 05.422.05 | □ 20 |
| H.1000 mm. | |
| Art. 05.422.06 | □ 12 |
| Art. 05.422.07 | □ 14 |
| Art. 05.422.08 | □ 16 |
| Art. 05.422.09 | □ 18 |
| Art. 05.422.10 | □ 20 |
| H.1200 mm. | |
| Art. 05.422.11 | □ 12 |
| Art. 05.422.12 | □ 14 |
| Art. 05.422.13 | □ 16 |
| Art. 05.422.14 | □ 18 |
| Art. 05.422.15 | □ 20 |
| H.1500 mm. | |
| Art. 05.422.16 | □ 12 |
| Art. 05.422.17 | □ 14 |
| Art. 05.422.18 | □ 16 |
| Art. 05.422.19 | □ 18 |
| Art. 05.422.20 | □ 20 |
| H.2000 mm. NEW | |
| Art. 05.422.02.2000 | □ 14 |

- Martellato / Hammered
- | | |
|----------------|------|
| H.950 mm. | |
| Art. 05.422.21 | □ 12 |
| Art. 05.422.22 | □ 14 |
| Art. 05.422.23 | □ 16 |
| Art. 05.422.24 | □ 18 |
| Art. 05.422.25 | □ 20 |
| H.1000 mm. | |
| Art. 05.422.26 | □ 12 |
| Art. 05.422.27 | □ 14 |
| Art. 05.422.28 | □ 16 |
| Art. 05.422.29 | □ 18 |
| Art. 05.422.30 | □ 20 |
| H.1200 mm. | |
| Art. 05.422.31 | □ 12 |
| Art. 05.422.32 | □ 14 |
| Art. 05.422.33 | □ 16 |
| Art. 05.422.34 | □ 18 |
| Art. 05.422.35 | □ 20 |
| H.1500 mm. | |
| Art. 05.422.36 | □ 12 |
| Art. 05.422.37 | □ 14 |
| Art. 05.422.38 | □ 16 |
| Art. 05.422.39 | □ 18 |
| Art. 05.422.40 | □ 20 |

- Tondo / Round
- | | |
|---------------------|-----|
| H.950 mm. | |
| Art. 05.422.41 | Ø12 |
| Art. 05.422.42 | Ø14 |
| Art. 05.422.43 | Ø16 |
| Art. 05.422.44 | Ø18 |
| H.1000 mm. | |
| Art. 05.422.45 | Ø12 |
| Art. 05.422.46 | Ø14 |
| Art. 05.422.47 | Ø16 |
| Art. 05.422.48 | Ø18 |
| H.1200 mm. | |
| Art. 05.422.49 | Ø12 |
| Art. 05.422.50 | Ø14 |
| Art. 05.422.51 | Ø16 |
| Art. 05.422.52 | Ø18 |
| H.1500 mm. | |
| Art. 05.422.53 | Ø12 |
| Art. 05.422.54 | Ø14 |
| Art. 05.422.55 | Ø16 |
| Art. 05.422.56 | Ø18 |
| H.2000 mm. NEW | |
| Art. 05.422.42.2000 | Ø14 |

- | | |
|----------------|------|
| H.950 mm. | |
| Art. 05.422.57 | □ 12 |
| Art. 05.422.58 | □ 14 |
| Art. 05.422.59 | □ 16 |
| Art. 05.422.60 | □ 18 |
| Art. 05.422.61 | □ 20 |
| H.1000 mm. | |
| Art. 05.422.62 | □ 12 |
| Art. 05.422.63 | □ 14 |
| Art. 05.422.64 | □ 16 |
| Art. 05.422.65 | □ 18 |
| Art. 05.422.66 | □ 20 |
| H.1200 mm. | |
| Art. 05.422.67 | □ 12 |
| Art. 05.422.68 | □ 14 |
| Art. 05.422.69 | □ 16 |
| Art. 05.422.70 | □ 18 |
| Art. 05.422.71 | □ 20 |
| H.1500 mm. | |
| Art. 05.422.72 | □ 12 |
| Art. 05.422.73 | □ 14 |
| Art. 05.422.74 | □ 16 |
| Art. 05.422.75 | □ 18 |
| Art. 05.422.76 | □ 20 |

PALLINE PICCOLE / SMALL BALLS



H.950 mm.
Art. 05.422.77 12
Art. 05.422.78 14
Art. 05.422.79 16

Martellato / *Hammered*
H.950 mm.
Art. 05.422.80 12
Art. 05.422.81 14
Art. 05.422.82 16

Tondo / *Round*
H.950 mm.
Art. 05.422.83 Ø14
Art. 05.422.84 Ø16

H.950 mm.
Art. 05.422.85 12
Art. 05.422.86 14
Art. 05.422.87 16

Martellato / *Hammered*
H.950 mm.
Art. 05.422.88 12
Art. 05.422.89 14
Art. 05.422.90 16

Tondo / *Round*
H.950 mm.
Art. 05.422.91 Ø14
Art. 05.422.92 Ø16

H.950 mm.
Art. 05.422.93 12
Art. 05.422.94 14
Art. 05.422.95 16

PALLINE PICCOLE / SMALL BALLS

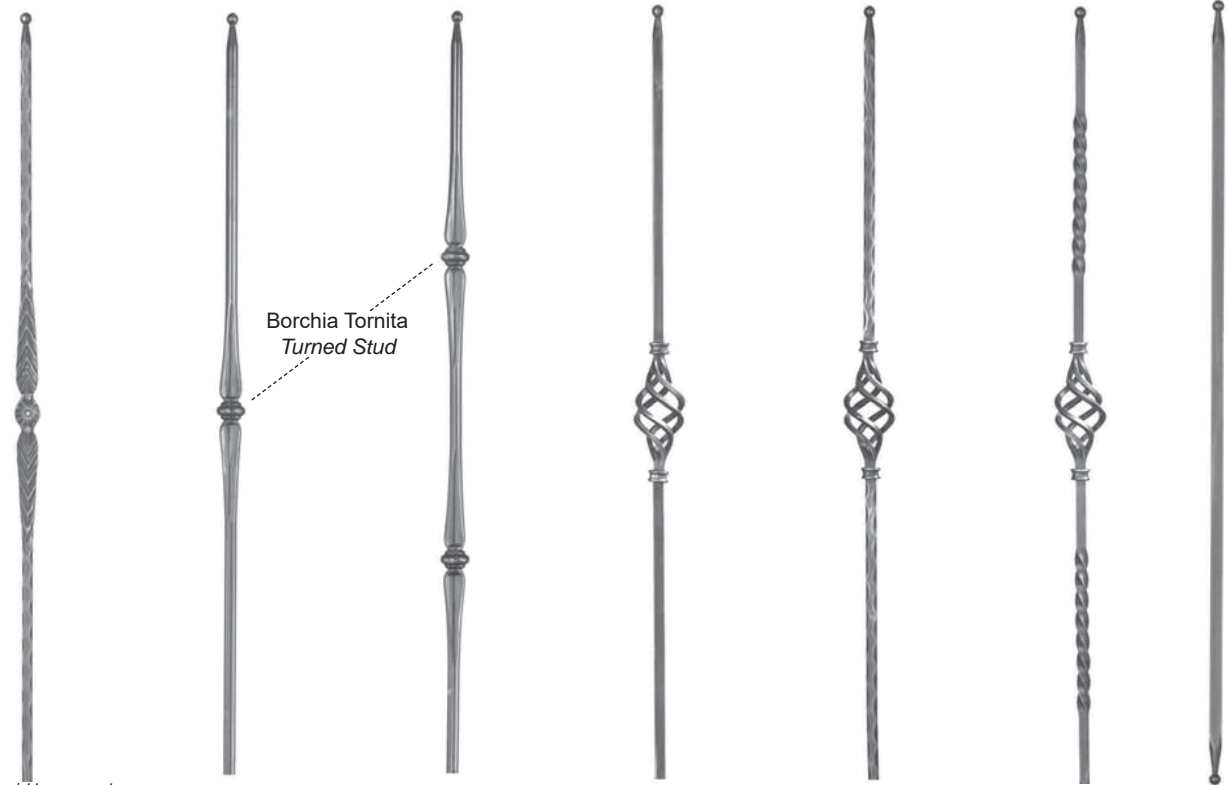

Martellato / *Hammered*
H.950 mm.
Art. 05.422.96 12
Art. 05.422.97 14
Art. 05.422.98 16

Tondo / *Round*
H.950 mm.
Art. 05.422.99 Ø12
Art. 05.422.100 Ø14

Borchia Tornita
Turned Stud

Tondo / *Round*
H.950 mm.
Art. 05.422.101 Ø12
Art. 05.422.102 Ø14

H.950 mm.
Art. 05.422.103 12
Art. 05.422.104 14

Martellato / *Hammered*
H.950 mm.
Art. 05.422.105 12
Art. 05.422.106 14

H.950 mm.
Art. 05.422.107 12
Art. 05.422.108 14

H.950 mm.
Art. 05.422.109 12
Art. 05.422.110 14
Art. 05.422.111 16
Art. 05.422.112 18
Art. 05.422.113 20







H.1000 mm.
Art. 05.422.114 12
Art. 05.422.115 14
Art. 05.422.116 16
Art. 05.422.117 18
Art. 05.422.118 20

H.1200 mm.
Art. 05.422.119 12
Art. 05.422.120 14
Art. 05.422.121 16
Art. 05.422.122 18
Art. 05.422.123 20







H.1500 mm.
Art. 05.422.124 12
Art. 05.422.125 14
Art. 05.422.126 16
Art. 05.422.127 18
Art. 05.422.128 20

Tutte le parti di questo catalogo - foto comprese - sono di proprietà Euro-Fer. La riproduzione, anche parziale, è vietata in ogni forma e con ogni mezzo. / Every part of this catalogue - photos included - is Euro-Fer's property. All forms of copying are strictly prohibited.

PALLINE PICCOLE / SMALL BALLS

 <p>Martellato / <i>Hammered</i></p> <p>H.950 mm.</p> <p>Art. 05.422.129 <input type="checkbox"/> 12 Art. 05.422.130 <input type="checkbox"/> 14 Art. 05.422.131 <input type="checkbox"/> 16 Art. 05.422.132 <input type="checkbox"/> 18 Art. 05.422.133 <input type="checkbox"/> 20</p> <p>H.1000 mm.</p> <p>Art. 05.422.134 <input type="checkbox"/> 12 Art. 05.422.135 <input type="checkbox"/> 14 Art. 05.422.136 <input type="checkbox"/> 16 Art. 05.422.137 <input type="checkbox"/> 18 Art. 05.422.138 <input type="checkbox"/> 20</p> <p>H.1200 mm.</p> <p>Art. 05.422.139 <input type="checkbox"/> 12 Art. 05.422.140 <input type="checkbox"/> 14 Art. 05.422.141 <input type="checkbox"/> 16 Art. 05.422.142 <input type="checkbox"/> 18 Art. 05.422.143 <input type="checkbox"/> 20</p> <p>H.1500 mm.</p> <p>Art. 05.422.144 <input type="checkbox"/> 12 Art. 05.422.145 <input type="checkbox"/> 14 Art. 05.422.146 <input type="checkbox"/> 16 Art. 05.422.147 <input type="checkbox"/> 18 Art. 05.422.148 <input type="checkbox"/> 20</p>	 <p>Tondo / <i>Round</i></p> <p>H.950 mm.</p> <p>Art. 05.422.149 <input type="checkbox"/> Ø12 Art. 05.422.150 <input type="checkbox"/> Ø14 Art. 05.422.151 <input type="checkbox"/> Ø16 Art. 05.422.152 <input type="checkbox"/> Ø18</p> <p>H.1000 mm.</p> <p>Art. 05.422.153 <input type="checkbox"/> Ø12 Art. 05.422.154 <input type="checkbox"/> Ø14 Art. 05.422.155 <input type="checkbox"/> Ø16 Art. 05.422.156 <input type="checkbox"/> Ø18</p> <p>H.1200 mm.</p> <p>Art. 05.422.157 <input type="checkbox"/> Ø12 Art. 05.422.158 <input type="checkbox"/> Ø14 Art. 05.422.159 <input type="checkbox"/> Ø16 Art. 05.422.160 <input type="checkbox"/> Ø18</p> <p>H.1500 mm.</p> <p>Art. 05.422.161 <input type="checkbox"/> Ø12 Art. 05.422.162 <input type="checkbox"/> Ø14 Art. 05.422.163 <input type="checkbox"/> Ø16 Art. 05.422.164 <input type="checkbox"/> Ø18</p>	 <p>H.950 mm.</p> <p>Art. 05.422.165 <input type="checkbox"/> 12 Art. 05.422.166 <input type="checkbox"/> 14 Art. 05.422.167 <input type="checkbox"/> 16 Art. 05.422.168 <input type="checkbox"/> 18 Art. 05.422.169 <input type="checkbox"/> 20</p> <p>H.1000 mm.</p> <p>Art. 05.422.170 <input type="checkbox"/> 12 Art. 05.422.171 <input type="checkbox"/> 14 Art. 05.422.172 <input type="checkbox"/> 16 Art. 05.422.173 <input type="checkbox"/> 18 Art. 05.422.174 <input type="checkbox"/> 20</p> <p>H.1200 mm.</p> <p>Art. 05.422.175 <input type="checkbox"/> 12 Art. 05.422.176 <input type="checkbox"/> 14 Art. 05.422.177 <input type="checkbox"/> 16 Art. 05.422.178 <input type="checkbox"/> 18 Art. 05.422.179 <input type="checkbox"/> 20</p> <p>H.1500 mm.</p> <p>Art. 05.422.180 <input type="checkbox"/> 12 Art. 05.422.181 <input type="checkbox"/> 14 Art. 05.422.182 <input type="checkbox"/> 16 Art. 05.422.183 <input type="checkbox"/> 18 Art. 05.422.184 <input type="checkbox"/> 20</p>	 <p>H.950 mm.</p> <p>Art. 05.422.185 <input type="checkbox"/> 12 Art. 05.422.186 <input type="checkbox"/> 14 Art. 05.422.187 <input type="checkbox"/> 16</p>	 <p>Martellato / <i>Hammered</i></p> <p>H.950 mm.</p> <p>Art. 05.422.188 <input type="checkbox"/> 12 Art. 05.422.189 <input type="checkbox"/> 14 Art. 05.422.190 <input type="checkbox"/> 16</p>	 <p>Tondo / <i>Round</i></p> <p>H.950 mm.</p> <p>Art. 05.422.191 <input type="checkbox"/> Ø14 Art. 05.422.192 <input type="checkbox"/> Ø16</p>
---	---	---	---	--	--

PALLINE PICCOLE / SMALL BALLS

 <p>H.950 mm.</p> <p>Art. 05.422.193 <input type="checkbox"/> 12 Art. 05.422.194 <input type="checkbox"/> 14 Art. 05.422.195 <input type="checkbox"/> 16</p>	 <p>Martellato / <i>Hammered</i></p> <p>H.950 mm.</p> <p>Art. 05.422.196 <input type="checkbox"/> 12 Art. 05.422.197 <input type="checkbox"/> 14 Art. 05.422.198 <input type="checkbox"/> 16</p>	 <p>Tondo / <i>Round</i></p> <p>H.950 mm.</p> <p>Art. 05.422.199 <input type="checkbox"/> Ø14 Art. 05.422.200 <input type="checkbox"/> Ø16</p>	 <p>H.950 mm.</p> <p>Art. 05.422.201 <input type="checkbox"/> 12 Art. 05.422.202 <input type="checkbox"/> 14 Art. 05.422.203 <input type="checkbox"/> 16</p>	 <p>Martellato / <i>Hammered</i></p> <p>H.950 mm.</p> <p>Art. 05.422.204 <input type="checkbox"/> 12 Art. 05.422.205 <input type="checkbox"/> 14 Art. 05.422.206 <input type="checkbox"/> 16</p>	 <p>Tondo / <i>Round</i></p> <p>H.950 mm.</p> <p>Art. 05.422.207 <input type="checkbox"/> Ø12 Art. 05.422.208 <input type="checkbox"/> Ø14</p>	 <p>Tondo / <i>Round</i></p> <p>H.950 mm.</p> <p>Art. 05.422.209 <input type="checkbox"/> Ø12 Art. 05.422.210 <input type="checkbox"/> Ø14</p>
---	---	---	---	---	---	---

Borchia Tornita
Turned Stud

Tutte le parti di questo catalogo - foto comprese - sono di proprietà Euro-Fer. La riproduzione, anche parziale, è vietata in ogni forma e con ogni mezzo. / Every part of this catalogue - photos included - is Euro-Fer's property. All forms of copying are strictly prohibited.

PANNELLI LISCI E PALETTI PER RECINZIONI
PLAIN PANEL UNITS AND STAKES FOR FENCES

PALLINE PICCOLE / SMALL BALLS



H.950 mm.
 Art. 05.422.211 12
 Art. 05.422.212 14



Martellato / Hammered
 H.950 mm.
 Art. 05.422.213 12
 Art. 05.422.214 14



H.950 mm.
 Art. 05.422.215 12
 Art. 05.422.216 14



Pallina piccola / Small ball
 Liscio / Smooth

H.950 mm

Art. 05.422.250 12 mm
 Art. 05.422.251 14 mm
 Art. 05.422.252 16 mm

H.1000 mm

Art. 05.422.253 12 mm
 Art. 05.422.254 14 mm
 Art. 05.422.255 16 mm

H.1200 mm

Art. 05.422.256 12 mm
 Art. 05.422.257 14 mm
 Art. 05.422.258 16 mm

H.1500 mm

Art. 05.422.259 12 mm
 Art. 05.422.260 14 mm
 Art. 05.422.261 16 mm



Pallina piccola / Small ball
 Martellato / Hammered

H.950 mm

Art. 05.422.300 12 mm
 Art. 05.422.301 14 mm
 Art. 05.422.302 16 mm

H.1000 mm

Art. 05.422.303 12 mm
 Art. 05.422.304 14 mm
 Art. 05.422.305 16 mm

H.1200 mm

Art. 05.422.306 12 mm
 Art. 05.422.307 14 mm
 Art. 05.422.308 16 mm

H.1500 mm

Art. 05.422.309 12 mm
 Art. 05.422.310 14 mm
 Art. 05.422.311 16 mm



Liscio / Smooth
 H.1000 mm
 Art. 05.427.01 12 mm
 Art. 05.427.02 14 mm



Liscio / Smooth
 H.1000 mm
 Art. 05.427.04 12 mm
 Art. 05.427.05 14 mm



Liscio / Smooth
 H.1000 mm
 Art. 05.427.07 12 mm
 Art. 05.427.08 14 mm



Liscio / Smooth
 H.1000 mm
 Art. 05.427.10 12 mm
 Art. 05.427.11 14 mm

NEW



Liscio / Smooth
 H.1000 mm
 Art. 05.427.20 12

NEW



Liscio / Smooth
 H.1000 mm
 Art. 05.427.21 12



Liscio / Smooth
 H.950 mm
 Art. 05.427.50 12
 Art. 05.427.51 14
 H.1000 mm
 Art. 05.427.52 12
 Art. 05.427.53 14
 H.1200 mm
 Art. 05.427.54 12
 Art. 05.427.55 14
 H.1500 mm
 Art. 05.427.56 12
 Art. 05.427.57 14

Modello Catania / Catania model

PALLINE SU BARRE / BALLS ON BARS

SU RICHIESTA SIAMO IN GRADO DI PRODURRE I SEGUENTI PALETTI CON PALLINA ANCHE SU MISURA.
 ON REQUEST WE ARE ABLE TO MANUFACTURE THE FOLLOWING BALL ON BAR INFILLS, CUSTOMIZED ALSO AVAILABLE.

Pallina / Ball Ø 16 mm - H. 1000

Art. 05.427.100 tondo liscio Ø 12 mm con pallina Ø 16 mm / round plain 12 mm solid bar with 16 mm ball

Pallina / Ball Ø 18 mm - H. 1000

Art. 05.427.110 tondo liscio Ø 12 mm con pallina Ø 18 mm / round plain 12 mm solid bar with 18 mm ball

Art. 05.427.112 tondo liscio Ø 14 mm con pallina Ø 18 mm / round plain 14 mm solid bar with 18 mm ball

Art. 05.427.115 quadro liscio □ 12x12 mm con pallina Ø 18 mm / square plain □ 12x12 mm solid bar with 18 mm ball

Pallina / Ball Ø 20 mm - H. 1000

Art. 05.427.130 tondo liscio Ø 12 mm con pallina Ø 20 mm / round plain 12 mm solid bar with 20 mm ball

Art. 05.427.132 tondo liscio Ø 14 mm con pallina Ø 20 mm / round plain 12 mm solid bar with 20 mm ball

Art. 05.427.134 tondo liscio Ø 16 mm con pallina Ø 20 mm / round plain 14 mm solid bar with 20 mm ball

Art. 05.427.140 quadro liscio □ 12x12 mm con pallina Ø 20 mm / square plain □ 12x12 mm solid bar with 20 mm ball

Art. 05.427.142 quadro liscio □ 14x14 mm con pallina Ø 20 mm / square plain □ 14x14 mm solid bar with 20 mm ball

Pallina / Ball Ø 24 mm - H. 1000

Art. 05.427.160 tondo liscio Ø 12 mm con pallina Ø 24 mm / round plain 12 mm solid bar with 24 mm ball

Art. 05.427.162 tondo liscio Ø 14 mm con pallina Ø 24 mm / round plain 12 mm solid bar with 24 mm ball

Art. 05.427.164 tondo liscio Ø 16 mm con pallina Ø 24 mm / round plain 14 mm solid bar with 24 mm ball

Art. 05.427.170 quadro liscio □ 12x12 mm con pallina Ø 24 mm / square plain □ 12x12 mm solid bar with 24 mm ball

Art. 05.427.172 quadro liscio □ 14x14 mm con pallina Ø 24 mm / square plain □ 14x14 mm solid bar with 24 mm ball

Art. 05.427.174 quadro liscio □ 16x16 mm con pallina Ø 24 mm / square plain □ 16x16 mm solid bar with 24 mm ball



Paletti / Bars H. 1000

Pigne a 9 Trafilati / 9 - Element Basket

Tubi ferro conformati / Cone - shaped iron tubes

H.730 mm.
 Art. 05.428 Ø 22
 Art. 05.429 Ø 30
 H.830 mm.
 Art. 05.430 Ø 22
 Art. 05.431 Ø 30

H.950 mm.
 Art. 05.432 □ 12

H.950 mm.
 Art. 05.433 □ 12

Martell. / Hammered
 H.950 mm.
 Art. 05.434 □ 12

Martell. / Hammered
 H.950 mm.
 Art. 05.435 □ 12

H.950 mm.
 Art. 05.436 Ø 15

Liscio / Smooth
 H.1000 mm
 Art. 05.436.10 □ 14
 Art. 05.436.15 □ 12

Liscio / Smooth
 H.1000 mm
 Art. 05.436.20 Ø 12

NEW NEW

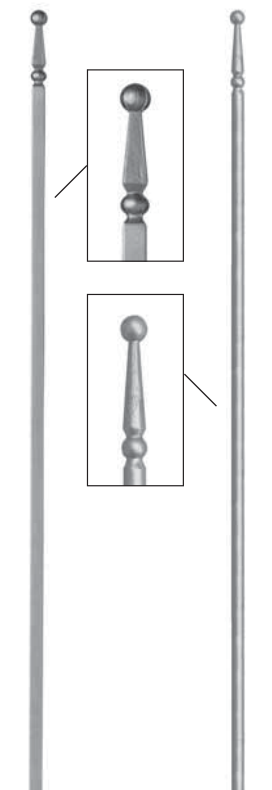

PANNELLI LISCI E PALETTI PER RECINZIONI
PLAIN PANEL UNITS AND STAKES FOR FENCES



H.900 X L.330 mm.
Art. 05.437 Ø 14



H.900 X L.350 mm.
Art. 05.437.01 ≙ 12 X 6 mm.
Art. 05.437.02 ≙ 14 X 6 mm.



Martellato / *Hammered*
 H.860 X L.350 mm.
Art. 05.438 ≙ 12 X 6 mm.
Art. 05.438.01 ≙ 16 X 5 mm.



Martellato / *Hammered*
 H.860 X L.350 mm.
Art. 05.438.02 ≙ 12 X 6 mm.
Art. 05.438.03 ≙ 16 X 5 mm.

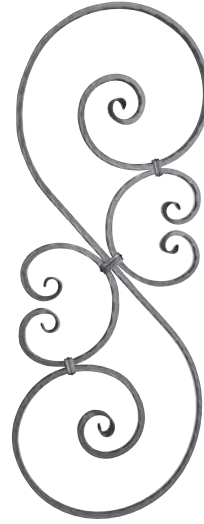

Liscio / *Smooth*
 H.900 X L.330 mm.
Art. 05.439 □ 14
 Martellato / *Hammered*
 H.900 X L.330 mm.
Art. 05.440 □ 14



Con fiori su ambo i lati
Flowers on both sides
 H.900 X L.350 mm.
Art. 05.440.01 □ 12



H.900 X L.350 mm.
Art. 05.440.02 Ø 10



Modello Scala / *Scala Model*
 H.860 x L.350 mm
Art. 05.440.03 ≙ 14 x 6 mm



Liscio / *Smooth*
 H.900 x L.370 mm
Art. 05.440.05 ≙ 12 x 6 mm



H.1100 mm.
Art. 05.441 □ 25
Art. 05.442 □ 30



Liscio / *Smooth*
 H.950 mm.
Art. 05.443 Ø 12



Liscio / *Smooth*
 H.950 mm.
Art. 05.444 Ø 12



Liscio / *Smooth*
 H.950 mm.
Art. 05.445 Ø 12

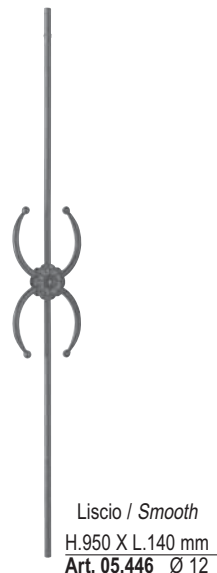

Liscio / *Smooth*
 H.950 X L.140 mm
Art. 05.446 Ø 12



Liscio / *Smooth*
 H.950 X L.100 mm.
Art. 05.447 Ø 12



Liscio / *Smooth*
 H.950 X L.100 mm.
Art. 05.448 Ø 12



Liscio / *Smooth*
 H.950 x L.180 mm
Art. 05.448.01 Ø 12 mm
 Con fiori su ambo i lati /
Flowers on both sides



Fiore in ottone / *Brass flower*



Liscio / *Smooth*
 H.950 x mm
Art. 05.448.02
 Ø 12 mm
Art. 05.448.03
 Ø 14 mm

Con fiori su ambo
 i lati / *Flowers
 on both sides*

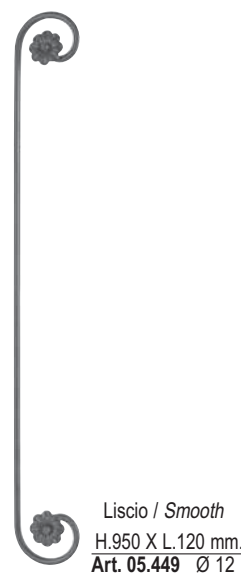

Liscio / *Smooth*
 H.950 X L.120 mm.
Art. 05.449 Ø 12

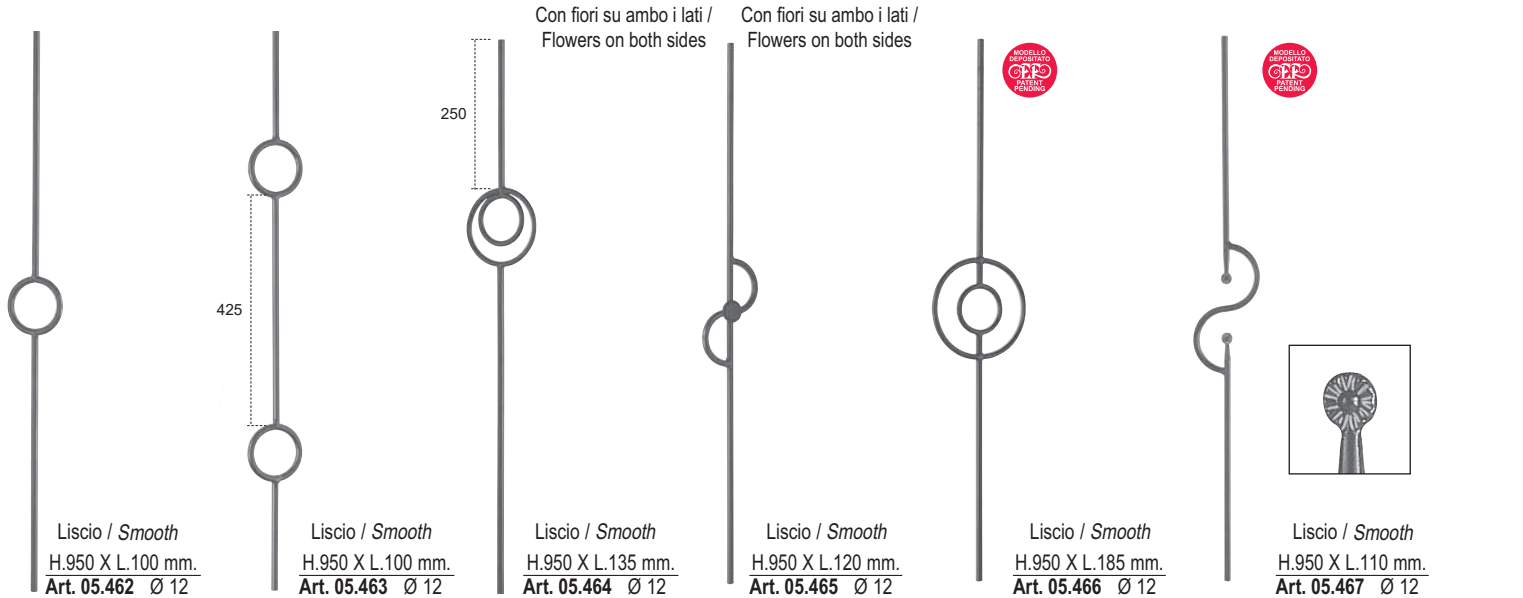
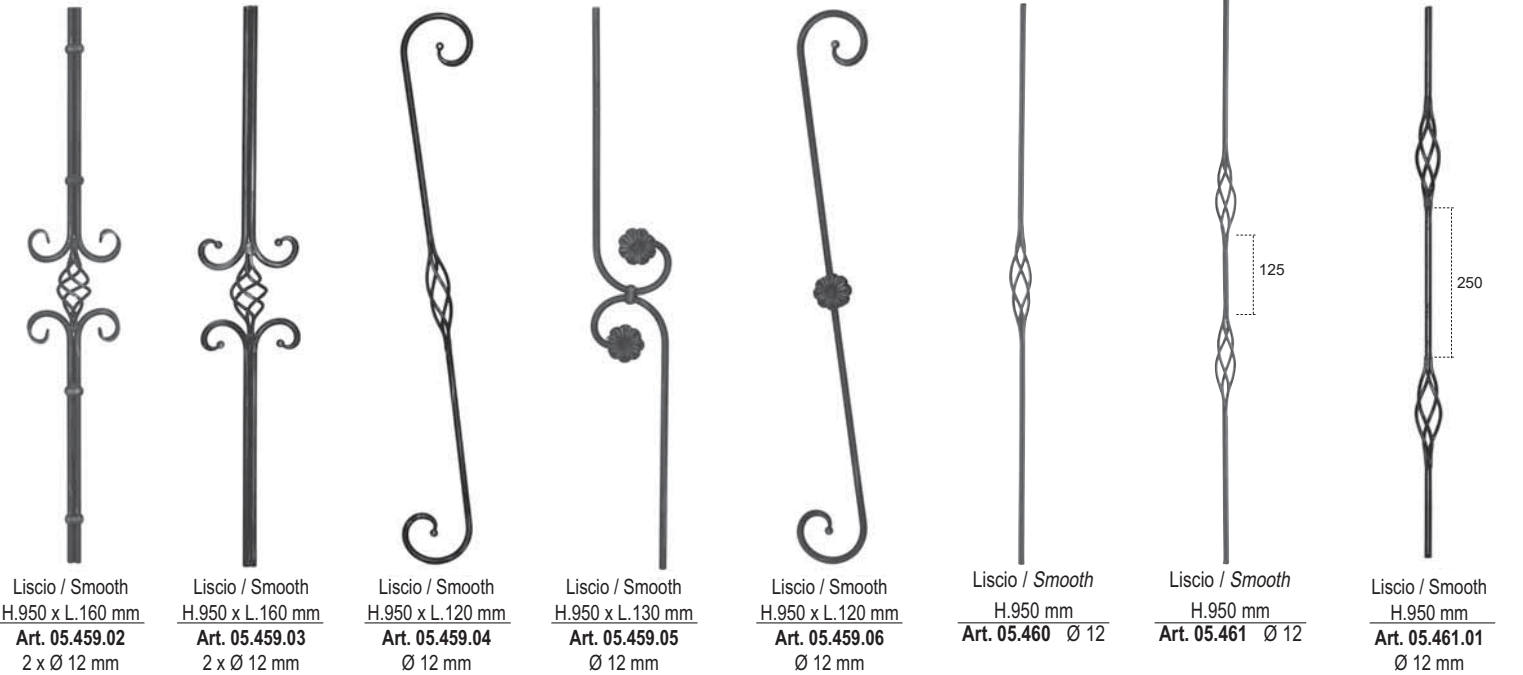
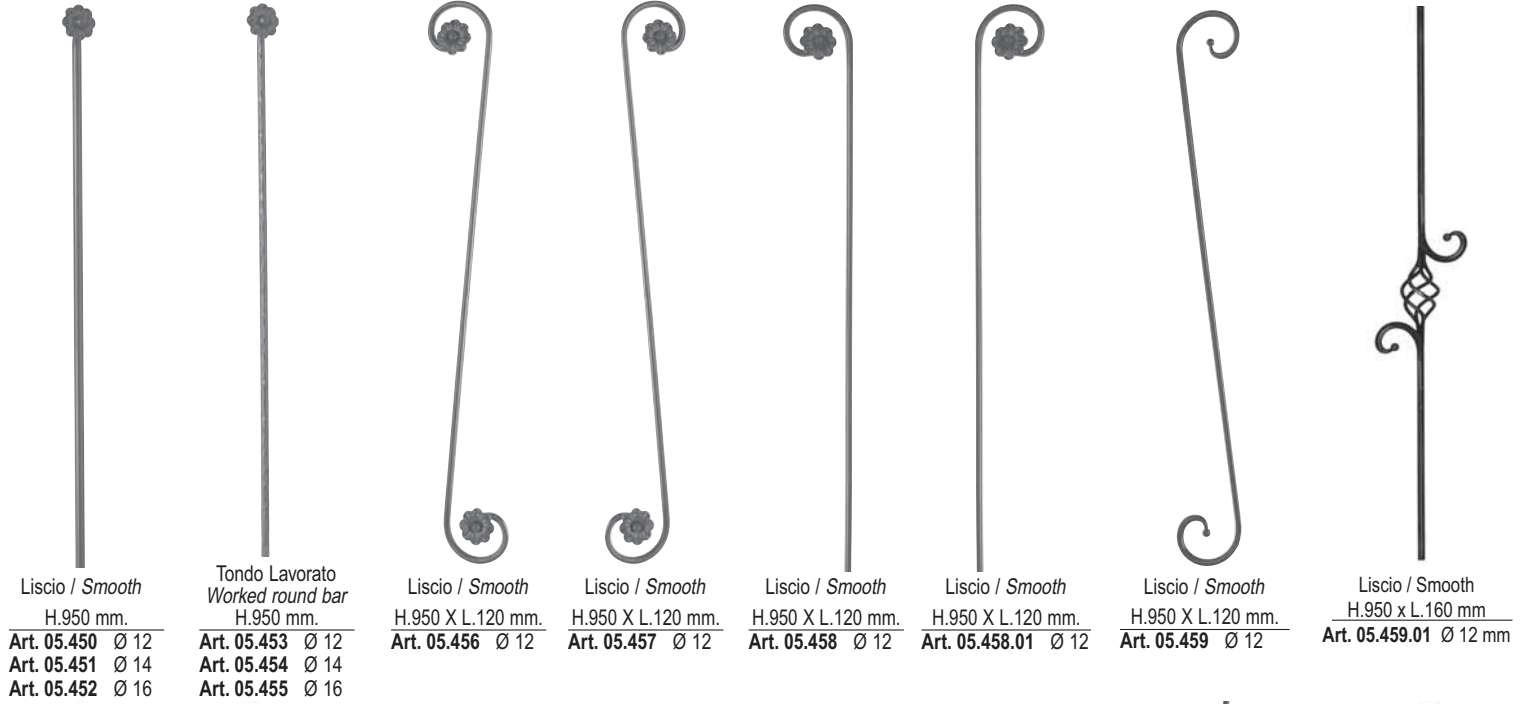

Tutte le parti di questo catalogo - foto comprese - sono di proprietà Euro-Fer. La riproduzione, anche parziale, è vietata in ogni forma e con ogni mezzo. / Every part of this catalogue - photos included - is Euro-Fer's property. All forms of copying are strictly prohibited.



Liscio / Smooth
 H.950 X L.100 mm.
 Art. 05.468 Ø 12



Liscio / Smooth
 H.950 X L.125 mm.
 Art. 05.469 Ø 12
 Art. 05.469.01 Ø 14



Liscio / Smooth
 H.950 X L.125 mm.
 Art. 05.470 Ø 12
 Art. 05.470.01 Ø 14



Liscio / Smooth
 H.950 X L.130 mm.
 Art. 05.471 Ø 12
 Art. 05.471.01 Ø 14



Liscio / Smooth
 H.950 X L.125 mm.
 Art. 05.472 Ø 12
 Art. 05.472.01 Ø 14



Liscio / Smooth
 H.950 X L.125 mm.
 Art. 05.473 Ø 12
 Art. 05.473.01 Ø 10



Liscio / Smooth
 H.950 X L.100 mm.
 Art. 05.474 Ø 10



Cerchio Hole Ø 90 mm
 Cerchio Hole Ø 100 mm
 Cerchio Hole Ø 90 mm
 H.950 X L.100 mm.
 Art. 05.475 Ø 10



Liscio / Smooth
 H.950 X L.140 mm.
 Art. 05.476 Ø 10



Liscio / Smooth
 H.950 X L.180 mm.
 Art. 05.477 Ø 12



Liscio / Smooth
 H.950 X L.75 mm.
 Art. 05.478 Ø 10
 Art. 05.478.01 Ø 12



Liscio / Smooth
 H.950 X L.85 mm.
 Art. 05.479 Ø 10
 Art. 05.479.01 Ø 12



Liscio / Smooth
 H.950 x L.150 mm
 Art. 05.479.02 Ø 12 mm



Liscio / Smooth
 H.1000 x L.45 mm
 Art. 05.479.10 Ø 12 mm



Liscio / Smooth
 H.1000 x L.45 mm
 Art. 05.479.11 Ø 12 mm



Liscio / Smooth
 H.1000 x L.45 mm
 Art. 05.479.12 Ø 12 mm



Liscio / Smooth
 H.1000 x L.45 mm
 Art. 05.479.13 Ø 12 mm



Liscio / Smooth
 H.1000 x L.130 mm
 Art. 05.479.14 Ø 12 mm



Liscio / Smooth
 H.1000 x L.45 mm
 Art. 05.479.15 Ø 12 mm



Liscio / Smooth
 H.1000 x L.55 mm
 Art. 05.479.16 Ø 12 mm



Liscio / Smooth
 H.1000 x L.85 mm
 Art. 05.479.18 Ø 12 mm



Liscio / Smooth
 H.1000 x L.85 mm
 Art. 05.479.19 Ø 12 mm



Liscio / Smooth
 H.1000 x L.65 mm
 Art. 05.479.20 Ø 12 mm



Liscio / Smooth
H.1000 x L.120 mm

Art. 05.479.29
□ 12 mm
Art. 05.479.30
□ 16 mm



Liscio / Smooth
H.1000 x L.120 mm
Art. 05.479.31
□ 16 mm



Liscio / Smooth
H.1000 x L.120 mm
Art. 05.479.32
□ 16 mm



Liscio / Smooth
H.1000 x L.120 mm
Art. 05.479.33
□ 16 mm



Liscio / Smooth
H.1000 x L.120 mm
Art. 05.479.34
□ 16 mm



Liscio / Smooth
H.1000 x L.120 mm
Art. 05.479.35
□ 16 mm



NEW

Liscio / Smooth
H.1000 x L.120 mm
Art. 05.479.50 □ 12 mm
Art. 05.479.51 □ 16 mm



NEW

Liscio / Smooth
H.1000 x L.120 mm
Art. 05.479.60
□ 12 mm
Art. 05.479.61
□ 16 mm



Liscio / Smooth
H.950 X L.175 mm.
Art. 05.480 Ø 14



Liscio / Smooth
H.950 X L.100 mm.
Art. 05.481 Ø 12



Liscio / Smooth
H.950 X L.100 mm.
Art. 05.482 Ø 12



Liscio / Smooth
H.950 X L.165 mm.
Art. 05.483 Ø 12



Liscio / Smooth
H.950 X L.165 mm.
Art. 05.484 Ø 12



Liscio / Smooth
H.950 X L.125 mm.
Art. 05.485 Ø 12



Liscio / Smooth
H.950 X L.130 mm.
Art. 05.486 Ø 12



Liscio / Smooth
H.950 X L.105 mm.
Art. 05.487 Ø 12

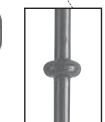

Con Ricalcatura
New Forged
Element

Liscio / Smooth
H.950 X L.100 mm.
Art. 05.488 Ø 12



Liscio / Smooth
H.950 X L.125 mm.
Art. 05.489 Ø 14



Liscio / Smooth
H.950 X L.110 mm.
Art. 05.490 Ø 14



Liscio / Smooth
H.950 X L.155 mm.
Art. 05.491 Ø 12

PANNELLI LISCI E PALETTI PER RECINZIONI
PLAIN PANEL UNITS AND STAKES FOR FENCES

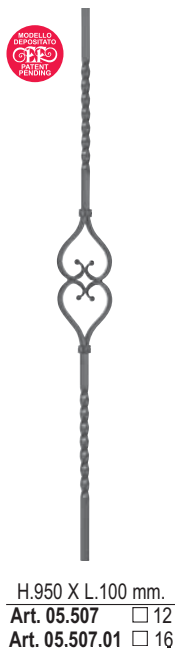
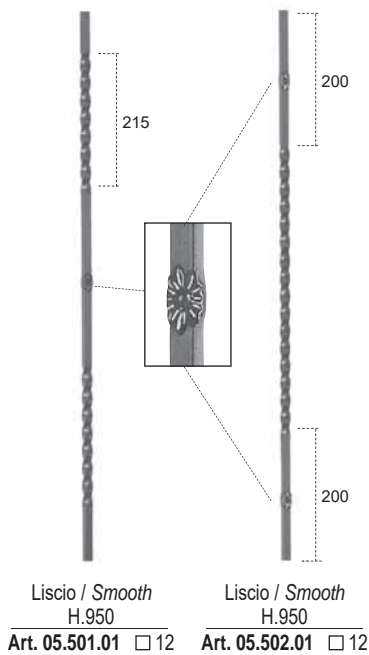
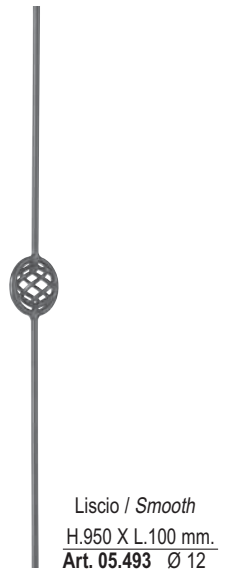
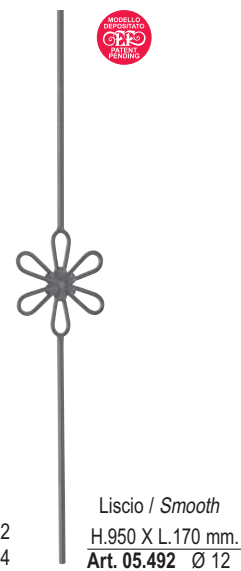
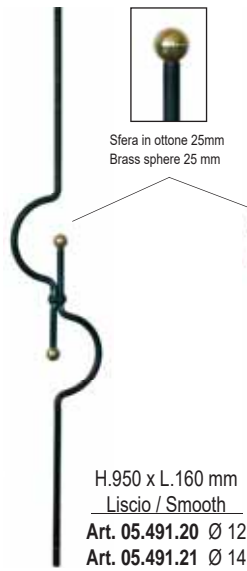
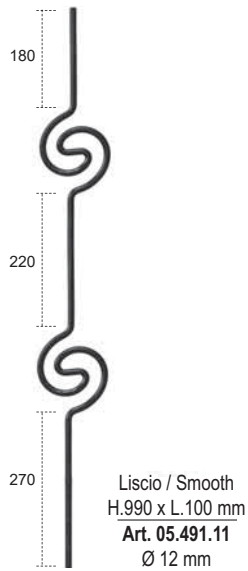
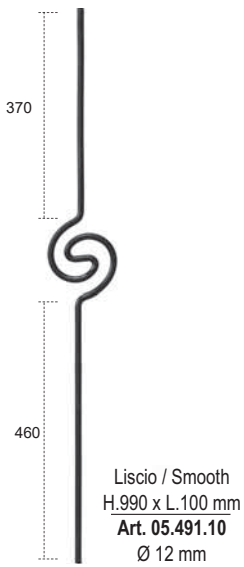



H.950 x L.115 mm
Martellato / *Hammered*
Art. 05.509.05 □ 12
Liscio / *Smooth*
Art. 05.509.06 □ 12



H.950 X L.90 mm.
Art. 05.510 □ 12



H.950 X L.145 mm.
Art. 05.511 □ 10



H.950 X L.140 mm.
Art. 05.512 □ 12



H.950 X L.140 mm.
Art. 05.513 □ 12



Liscio / *Smooth*
H.1000 x L.120 mm
Art. 05.513.100 □ 16
Art. 05.513.101 □ 20



Liscio / *Smooth*
H.1000 x L.120 mm
Art. 05.513.102 □ 16



Liscio / *Smooth*
H.1000 x L.120 mm
Art. 05.513.103 □ 16



Liscio / *Smooth*
H.1000 x L.135 mm
Art. 05.513.104 □ 16
Art. 05.513.105 □ 20



Liscio / *Smooth*
H.1000 x L.120 mm
Art. 05.513.106 □ 16



Liscio / *Smooth*
H.1000 x L.155 mm
Art. 05.513.107 □ 16



Liscio / *Smooth*
H.1000 x L.165 mm
Art. 05.513.108 □ 16



Liscio / *Smooth*
H.1000 x L.135 mm
Art. 05.513.109 □ 16



Liscio / *Smooth*
H.1000 x L.200 mm
Art. 05.513.110
□ 16 ≠ 16 x 8



Liscio / *Smooth*
H.1000 x L.190 mm
Art. 05.513.111
□ 16 ≠ 16 x 8



Liscio / *Smooth*
H.1000 x L.140 mm
Art. 05.513.112 □ 16



Liscio / *Smooth*
H.950 X L.200 mm.
Art. 05.515 □ 10



Liscio / *Smooth*
H.950 X L.165 mm.
Art. 05.516 □ 10



Liscio / *Smooth*
H.950 X L.200 mm.
Art. 05.517 □ 12

PANNELLI LISCI E PALETTI PER RECINZIONI
PLAIN PANEL UNITS AND STAKES FOR FENCES



Liscio / Smooth
H.950 X L.180 mm.
Art. 05.519 □ 12



Liscio / Smooth
H.950 X L.220 mm.
Art. 05.520 □ 12
≠ 12 x 6



Liscio / Smooth
H.950 X L.175 mm.
Art. 05.521 □ 10
≠ 12 x 6

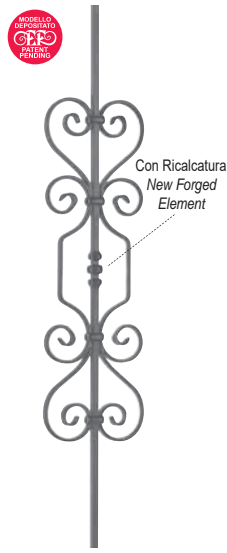

Liscio / Smooth
H.950 X L.180 mm.
Art. 05.522 □ 12



Liscio / Smooth
H.950 mm.
Art. 05.523 □ 12



Liscio / Smooth
H.950 mm.
Art. 05.523.01 □ 12



Martellato / Hammered
H.950 mm.
Art. 05.524 □ 12
Art. 05.524.01 □ 14



Martellato / Hammered
H.950 mm.
Art. 05.524.02 □ 12
Art. 05.524.03 □ 14



Liscio / Smooth
H.950 mm.
Art. 05.525 □ 12
Art. 05.525.01 □ 14



Liscio / Smooth
H.950 mm.
Art. 05.525.02 □ 12
Art. 05.525.03 □ 14



Liscio / Smooth
H.950 x L.60 mm
Art. 05.525.04 □ 12 mm



Liscio / Smooth
H.950 x L.60 mm
Art. 05.525.06 □ 12 mm



Liscio / Smooth
H.950 x L.75 mm
Art. 05.525.12 □ 12



Liscio / Smooth
H.950 mm.
Art. 05.526 □ 14
Art. 05.526.01 □ 12



Martellato / Hammered
H.950 mm.
Art. 05.527 □ 14
Art. 05.527.01 □ 12



Sfera / Sphere
Ø22



H.950 mm
Art. 05.527.10 □ 12
H.1000 mm
Art. 05.527.11 □ 12



Sfera / Sphere Ø35

Art. 05.527.45 Ø12 H 950 mm
Art. 05.527.46 Ø12 H 1000 mm
Art. 05.527.47 Ø12 H 1200 mm

H 950 mm
Art. 05.527.50 Ø16
Art. 05.527.51 □ 12
Art. 05.527.52 □ 14

H 1000 mm
Art. 05.527.53 Ø16
Art. 05.527.54 □ 12
Art. 05.527.55 □ 14

H 1200 mm
Art. 05.527.56 Ø16
Art. 05.527.57 □ 12
Art. 05.527.58 □ 14

H 1500 mm
Art. 05.527.59 Ø16



Sfera / Sphere Ø30

Art. 05.527.60 Ø12 H 950 mm
Art. 05.527.61 Ø12 H 1000 mm
Art. 05.527.62 Ø12 H 1200 mm

Art. 05.527.64 Ø14 H 950 mm
Art. 05.527.65 Ø14 H 1000 mm
Art. 05.527.66 Ø14 H 1200 mm

Sfera / Sphere Ø25

H 950 mm
Art. 05.527.70 Ø12
Art. 05.527.71 Ø14

H 1000 mm
Art. 05.527.73 Ø12
Art. 05.527.74 Ø14

H 1200 mm
Art. 05.527.76 Ø12
Art. 05.527.77 Ø14

H 1500 mm
Art. 05.527.79 Ø12
Art. 05.527.80 Ø14

Art. 05.527.81 □ 12 H 950 mm
Art. 05.527.82 □ 12 H 1000 mm
Art. 05.527.83 □ 12 H 1200 mm

Sfera / Sphere Ø20

Art. 05.527.90 Ø12 H 950 mm
Art. 05.527.91 Ø12 H 1000 mm
Art. 05.527.92 Ø12 H 1200 mm



Sfera Forgiata Ø 25
/ Forged Sphere Ø 25

Art. 05.527.100 Ø12 H 1000 mm



Lancia elettrosaldata /
Electro-welded spear

Lancia mod. /
Spear mod.
Art.13.072

Liscio / Smooth

H.950 mm.

Art. 05.528 □ 12

Art. 05.528.01 □ 14

H.1000 mm.

Art. 05.528.02 □ 12

Art. 05.528.03 □ 14

H.1200 mm.

Art. 05.528.04 □ 12

Art. 05.528.05 □ 14

H.1500 mm.

Art. 05.528.06 □ 12

Art. 05.528.07 □ 14

Lancia elettrosaldata /
Electro-welded spear

Lancia mod. /
Spear mod.
Art.13.060.02

Liscio / Smooth

H.950 mm.

Art. 05.529 □ 12

Art. 05.529.01 □ 14

H.1000 mm.

Art. 05.529.02 □ 12

Art. 05.529.03 □ 14

H.1200 mm.

Art. 05.529.04 □ 12

Art. 05.529.05 □ 14

H.1500 mm.

Art. 05.529.06 □ 12

Art. 05.529.07 □ 14

Lancia elettrosaldata /
Electro-welded spear

Lancia mod. /
Spear mod.
Art.13.056

Liscio / Smooth

H.950 mm.

Art. 05.530 Ø 12

Art. 05.530.01 Ø 14

H.1000 mm.

Art. 05.530.02 Ø 12

Art. 05.530.03 Ø 14

H.1200 mm.

Art. 05.530.04 Ø 12

Art. 05.530.05 Ø 14

H.1500 mm.

Art. 05.530.06 Ø 12

Art. 05.530.07 Ø 14

Lancia elettrosaldata /
Electro-welded spear

Lancia mod. /
Spear mod.
Art.13.098.02

Liscio / Smooth

H.950 mm.

Art. 05.531 □ 12

Art. 05.531.01 Ø 14

H.1000 mm.

Art. 05.531.02 Ø 12

Art. 05.531.03 Ø 14

H.1200 mm.

Art. 05.531.04 Ø 12

Art. 05.531.05 Ø 14

H.1500 mm.

Art. 05.531.06 Ø 12

Art. 05.531.07 Ø 14

Lancia elettrosaldata /
Electro-welded spear

Lancia mod. /
Spear mod.
Art.13.092

Liscio / Smooth

H.950 mm

Art. 05.531.08 □ 12 mm

Art. 05.531.09 □ 14 mm

H.1000 mm

Art. 05.531.10 □ 12 mm

Art. 05.531.11 □ 14 mm

H.1200 mm

Art. 05.531.12 □ 12 mm

Art. 05.531.13 □ 14 mm

H.1500 mm

Art. 05.531.14 □ 12 mm

Art. 05.531.15 □ 14 mm

Lancia elettrosaldata /
Electro-welded spear

Lancia mod. /
Spear mod.
Art.13.077

H.950 mm

Art. 05.531.16 □ 12 mm

Art. 05.531.17 □ 14 mm

H.1000 mm

Art. 05.531.18 □ 12 mm

Art. 05.531.19 □ 14 mm

H.1200 mm

Art. 05.531.20 □ 12 mm

Art. 05.531.21 □ 14 mm

H.1500 mm

Art. 05.531.22 □ 12 mm

Art. 05.531.23 □ 14 mm

Lancia elettrosaldata /
Electro-welded spear

Lancia mod. /
Spear mod.
Art.13.061

H.950 mm

Art. 05.531.24 Ø 16 mm

H.1000 mm

Art. 05.531.25 Ø 16 mm

H.1200 mm

Art. 05.531.26 Ø 16 mm

H.1500 mm

Art. 05.531.27 Ø 16 mm

Lancia elettrosaldata /
Electro-welded spear

Lancia mod. /
Spear mod.
Art.13.077.06

H.950 mm

Art. 05.531.28 Ø 12 mm

Art. 05.531.29 Ø 14 mm

H.1000 mm

Art. 05.531.30 Ø 12 mm

Art. 05.531.31 Ø 14 mm

H.1200 mm

Art. 05.531.32 Ø 12 mm

Art. 05.531.33 Ø 14 mm

H.1500 mm

Art. 05.531.34 Ø 12 mm

Art. 05.531.35 Ø 14 mm



Art. 05.531.80
□ 12 H 950 mm
Art. 05.531.81
□ 12 H 1000 mm
Art. 05.531.82
□ 12 H 1200 mm



Art. 05.531.100
Ø 12 H 1000 mm
Art. 05.531.101
Ø 12 H 1200 mm

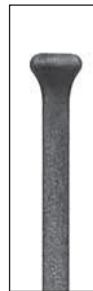

Art. 05.531.110
□ 12 H 1000 mm
Art. 05.531.111
□ 12 H 1200 mm

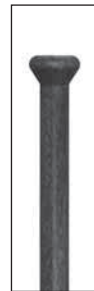

Art. 05.531.116
Ø 12 H 1000 mm
Art. 05.531.117
Ø 12 H 1200 mm



Art. 05.531.120
Ø 12 H 1000 mm
Art. 05.531.121
Ø 12 H 1200 mm

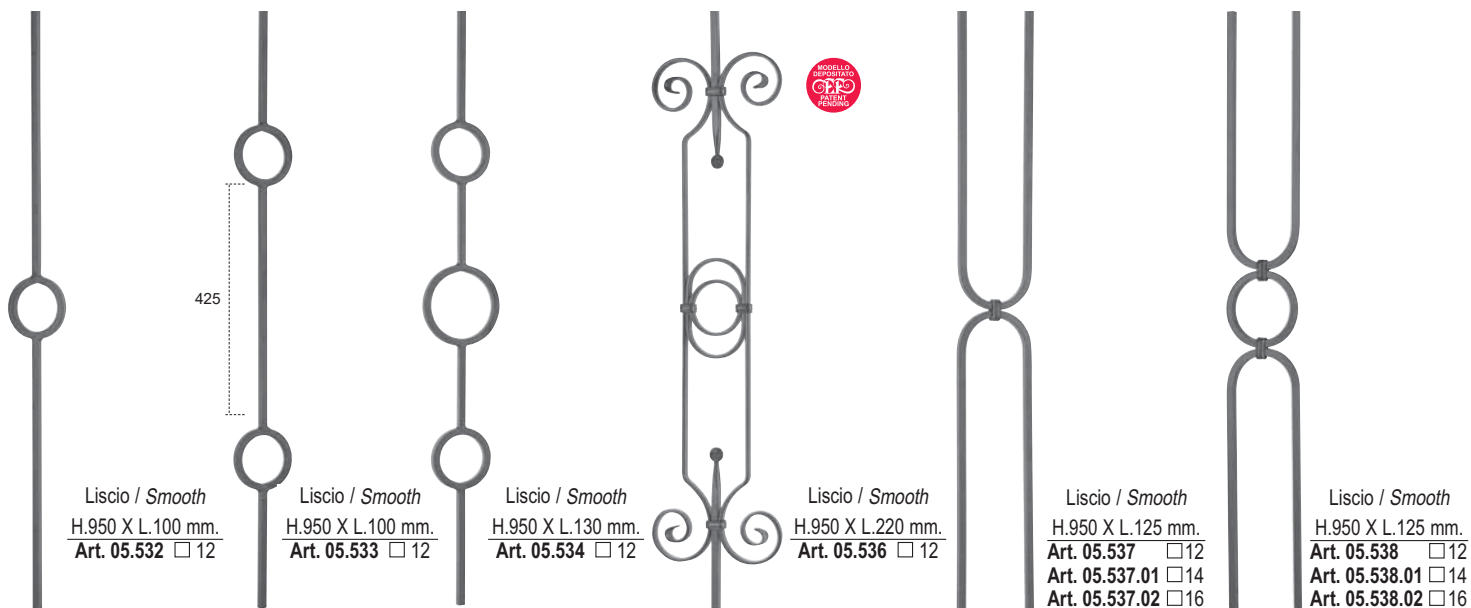

Liscio / Smooth
H.950 X L.100 mm.
Art. 05.532 □ 12

Liscio / Smooth
H.950 X L.100 mm.
Art. 05.533 □ 12

Liscio / Smooth
H.950 X L.130 mm.
Art. 05.534 □ 12

Liscio / Smooth
H.950 X L.220 mm.
Art. 05.536 □ 12

Liscio / Smooth
H.950 X L.125 mm.
Art. 05.537 □ 12
Art. 05.537.01 □ 14
Art. 05.537.02 □ 16

Liscio / Smooth
H.950 X L.125 mm.
Art. 05.538 □ 12
Art. 05.538.01 □ 14
Art. 05.538.02 □ 16

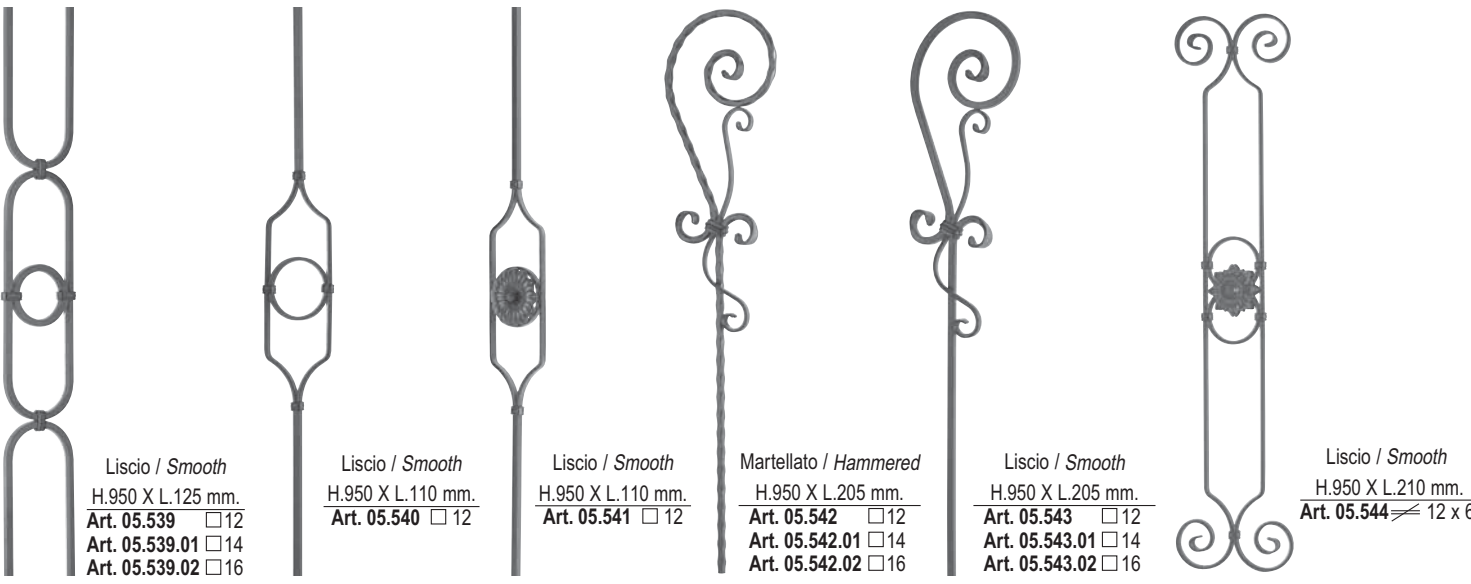

Liscio / Smooth
H.950 X L.125 mm.
Art. 05.539 □ 12
Art. 05.539.01 □ 14
Art. 05.539.02 □ 16

Liscio / Smooth
H.950 X L.110 mm.
Art. 05.540 □ 12

Liscio / Smooth
H.950 X L.110 mm.
Art. 05.541 □ 12

Martellato / Hammered
H.950 X L.205 mm.
Art. 05.542 □ 12
Art. 05.542.01 □ 14
Art. 05.542.02 □ 16

Liscio / Smooth
H.950 X L.205 mm.
Art. 05.543 □ 12
Art. 05.543.01 □ 14
Art. 05.543.02 □ 16

Liscio / Smooth
H.950 X L.210 mm.
Art. 05.544 ≠ 12 x 6

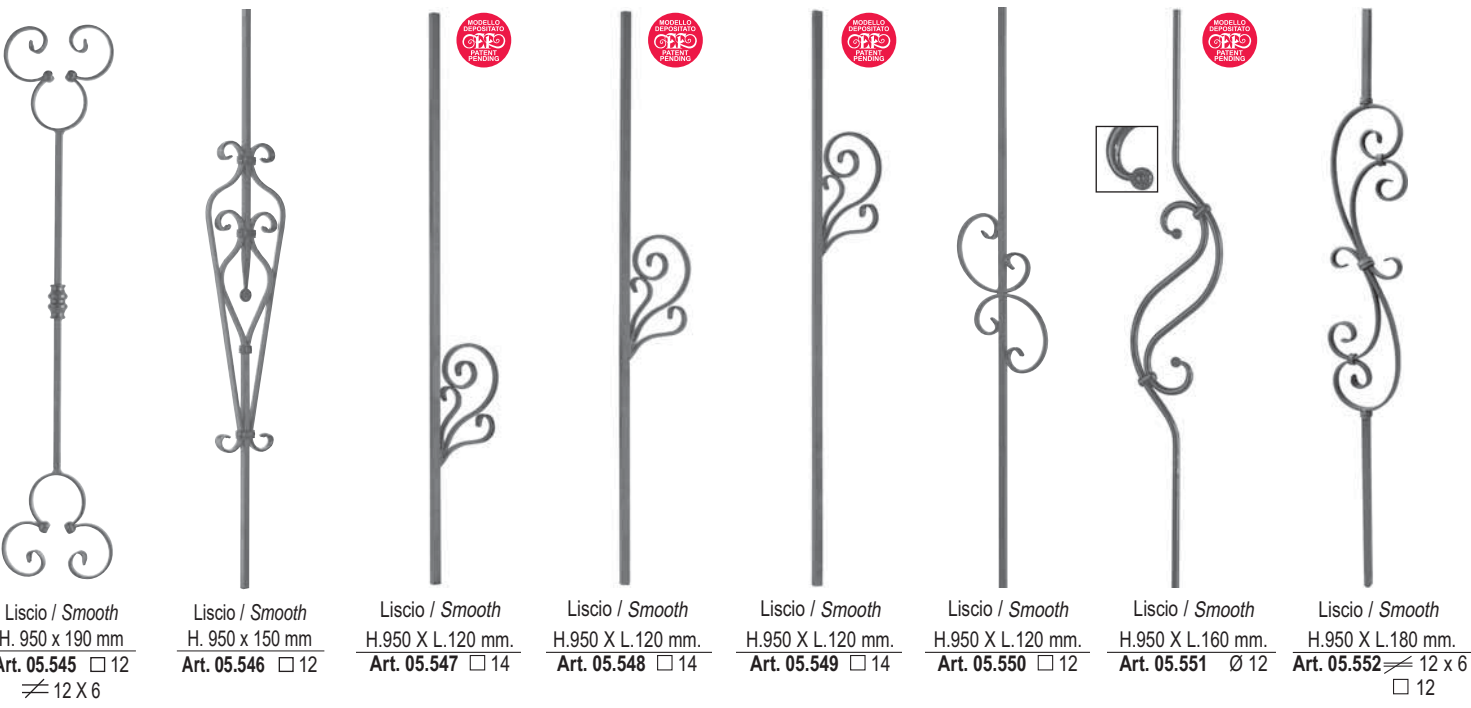

Liscio / Smooth
H. 950 x 190 mm
Art. 05.545 □ 12
≠ 12 X 6

Liscio / Smooth
H. 950 x 150 mm
Art. 05.546 □ 12

Liscio / Smooth
H.950 X L.120 mm.
Art. 05.547 □ 14

Liscio / Smooth
H.950 X L.120 mm.
Art. 05.548 □ 14

Liscio / Smooth
H.950 X L.120 mm.
Art. 05.549 □ 14

Liscio / Smooth
H.950 X L.120 mm.
Art. 05.550 □ 12

Liscio / Smooth
H.950 X L.160 mm.
Art. 05.551 Ø 12

Liscio / Smooth
H.950 X L.180 mm.
Art. 05.552 ≠ 12 x 6
□ 12

Tutte le parti di questo catalogo - foto comprese - sono di proprietà Euro-Fer. La riproduzione, anche parziale, è vietata in ogni forma e con ogni mezzo. / Every part of this catalogue - photos included - is Euro-Fer's property. All forms of copying are strictly prohibited.

PS
 pallina "a sole"
 sun ball



Martellato / *Hammered*

- H.950 mm.
 Art. 05.553 □ 12
 Art. 05.553.01 □ 14
 Art. 05.553.02 Ø 12
 Art. 05.553.03 Ø 14
- H.1000 mm.
 Art. 05.553.04 □ 12
 Art. 05.553.05 □ 14
 Art. 05.553.06 Ø 12
 Art. 05.553.07 Ø 14
- H.1200 mm.
 Art. 05.553.08 □ 12
 Art. 05.553.09 □ 14
 Art. 05.553.10 Ø 12
 Art. 05.553.11 Ø 14
- H.1500 mm.
 Art. 05.553.12 □ 12
 Art. 05.553.13 □ 14
 Art. 05.553.14 Ø 12
 Art. 05.553.15 Ø 14

Liscio / *Smooth*

- H.950 mm.
 Art. 05.554 □ 12
 Art. 05.554.01 □ 14
 Art. 05.554.02 Ø 12
 Art. 05.554.03 Ø 14
- H.1000 mm.
 Art. 05.554.04 □ 12
 Art. 05.554.05 □ 14
 Art. 05.554.06 Ø 12
 Art. 05.554.07 Ø 14
- H.1200 mm.
 Art. 05.554.08 □ 12
 Art. 05.554.09 □ 14
 Art. 05.554.10 Ø 12
 Art. 05.554.11 Ø 14
- H.1500 mm.
 Art. 05.554.12 □ 12
 Art. 05.554.13 □ 14
 Art. 05.554.14 Ø 12
 Art. 05.554.15 Ø 14

Tondo Lavorato
Worked Round Bar
 H.950 mm.

- Art. 05.555 Ø 12
 Art. 05.555.01 Ø 14
- H.1000 mm.
 Art. 05.555.02 Ø 12
 Art. 05.555.03 Ø 14
- H.1200 mm.
 Art. 05.555.04 Ø 12
 Art. 05.555.05 Ø 14
- H.1500 mm.
 Art. 05.555.06 Ø 12
 Art. 05.555.07 Ø 14

Liscio / *Smooth*

- H.950 mm.
 Art. 05.556 Ø 12
 Art. 05.556.01 Ø 14
- H.1000 mm.
 Art. 05.556.02 Ø 12
 Art. 05.556.03 Ø 14
- H.1200 mm.
 Art. 05.556.04 Ø 12
 Art. 05.556.05 Ø 14
- H.1500 mm.
 Art. 05.556.06 Ø 12
 Art. 05.556.07 Ø 14



NEW



Liscio / *Smooth*
 H.950 X L.250 mm.
 Art. 05.560 Ø 10
 Art. 05.560.01 Ø 12



Liscio / *Smooth*
 H.950 x L.420 mm
 Art. 05.560.02 Ø 12 mm

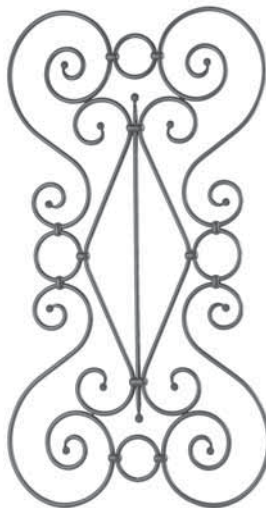

Liscio / *Smooth*
 H.950 X L.520 mm.
 Art. 05.561 Ø 10
 Art. 05.561.01 Ø 12



Liscio / *Smooth*
 H.950 x L.420 mm
 Art. 05.561.02 Ø 12
 Con fiori su ambo i lati /
 Flowers on both sides

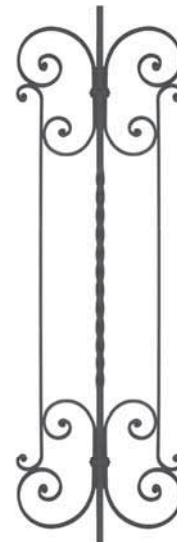

Liscio / *Smooth*
 H.1000 x L.310 mm
 Art. 05.561.05
 □ 12 mm ≠ 12 x 6 mm



Liscio / *Smooth*
 H.900 X L.175 mm.
 Art. 05.562 Ø 12



Tutte le parti di questo catalogo - foto comprese - sono di proprietà Euro-Fer. La riproduzione, anche parziale, è vietata in ogni forma e con ogni mezzo. / Every part of this catalogue - photos included - is Euro-Fer's property. All forms of copying are strictly prohibited.



NEW



NEW



NEW

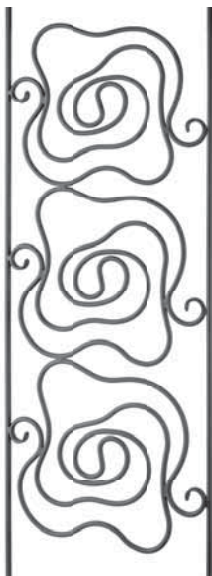

Art. 05.562.20
Liscio / Smooth
H.1200 x L.420 mm ca.
Rosa / Rose Ø 10 mm
Paletto / Bar Ø 12 mm



Art. 05.562.21
Martellato / Hammered
H.1200 x L.420 mm ca.
Rosa / Rose Ø 12 mm
Paletto / Bar Ø 12 mm

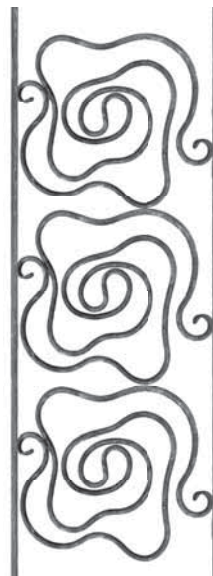

Art. 05.562.22
Modello Corteccia / Bark Model
H.1200 x L.420 mm ca.
Rosa / Rose Ø 12 mm
Paletto / Bar Ø 12 mm



Art. SW 05.562.20
Liscio / Smooth
H.1200 x L.420 mm ca.
Rosa / Rose Ø 10 mm
Paletto / Bar Ø 12 mm

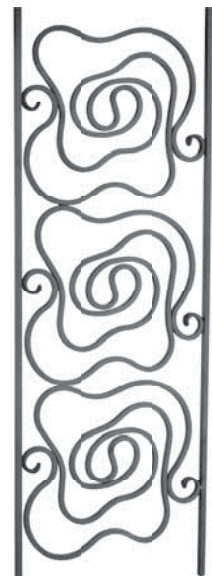

Art. 05.563.20
Liscio / Smooth
H.1200 x L.420 mm ca.
Rosa / Rose □ 10 mm
Paletto / Bar □ 12 mm



Art. SW 05.563.20
Liscio / Smooth
H.1200 x L.420 mm ca.
Rosa / Rose □ 10 mm
Paletto / Bar □ 12 mm

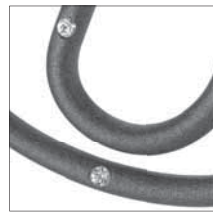
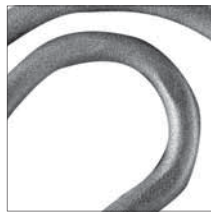

ROSE COLLECTION
CRYSTALS FROM SWAROVSKI*

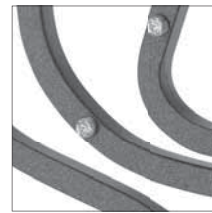

ROSE COLLECTION
CRYSTALS FROM SWAROVSKI*



Liscio / Smooth
H. 1000 X L. 400 mm
Art. 05.562.25
Rosa/rose Ø 12



Liscio / Smooth
H.950 X L. 120 mm.
Art. 05.563 Ø 12



Liscio / Smooth
H.950 X L. 120 mm.
Art. 05.564 Ø 12

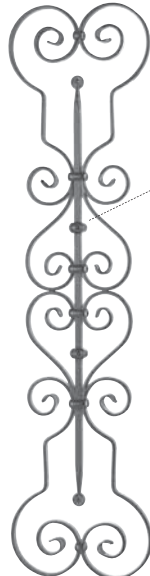

Liscio / Smooth
H.950 X L.245mm.
Art. 05.565 12 x 6
□ 12

Con Ricalcatura
New Forged
Element



Liscio / Smooth
H.950 x L.190 mm
Art. 05.566 Ø 12
Art. 05.567 □ 12



Liscio / Smooth
H.950 x L.240 mm
Art. 05.568 Ø 12
Art. 05.569 □ 12



Liscio / Smooth
H.950 x L.210 mm
Art. 05.570 Ø 12



Liscio / Smooth
H.950 x L.230 mm
Art. 05.590 Ø 12
Con fiori su ambo i lati /
Flowers on both sides



Rigato / Fluted
H.950 x L.100 mm
Art. 05.591 □ 14
Art. 05.591.01 □ 12
Con fiori su ambo i lati /
Flowers on both sides



Profilo a nuvola /
Cloud profile

Profilo nuvola /
Cloud profile
H.950 mm
Art. 05.592 ≇ 20 x 12



Profilo nuvola /
Cloud profile
H.950 mm
Art. 05.592.01 ≇ 20 x 12



Forgiato / Forged
H.950 mm
Art. 05.593 □ 14



Pigna schiacciata /
Flatted Basket

Forgiato / Forged
H.950 mm
Art. 05.593.01 □ 14

Con borchia in Acciaio Fuso / With Cast Steel stud Art.CI.13.921



Liscio / Smooth
H.950 x L.114 mm
Art. 05.600 □ 14



Liscio / Smooth
H.950 mm
Art. 05.700 Ø 16 x 1,5
Tubo / Pipe bar



370

Liscio / Smooth
H.950 mm
Art. 05.701 Ø 16 x 1,5
Tubo / Pipe bar



Liscio / Smooth
H.950 mm
Art. 05.702 Ø 16 x 1,5
Tubo / Pipe bar



Liscio / Smooth
H.1750 x L.320 mm
Art. 05.729.08
□ 20 mm ≇ 16 x 8 mm



Liscio / Smooth
H.1750 x L.320 mm
Art. 05.729.09
□ 20 mm ≇ 16 x 8 mm

🌀 fiori da entrambi i lati / flowers on both sides

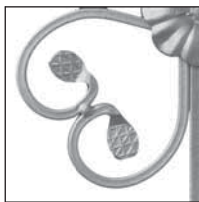

🌀 Liscio / Smooth
H. 950 X L. 190 mm.
Art. 05.800
□ 12
≠ 12 x 6



Liscio / Smooth
H. 950 X L. 210 mm.
Art. 05.801
Ø 12



🌀 Liscio / Smooth
H. 950 X L. 150 mm.
Art. 05.802
□ 12
Ø 12



🌀 Liscio / Smooth
H. 950 X L. 150 mm.
Art. 05.803
Ø 12



Liscio / Smooth
H. 950 X L. 150 mm.
Art. 05.804
Ø 10



Liscio / Smooth
H. 950 X L. 160 mm.
Art. 05.805
□ 12
≠ 12 x 6



Liscio / Smooth
H. 950 X L. 205 mm.
Art. 05.806
□ 10
≠ 10 x 5



Liscio / Smooth
H. 950 X L. 95 mm.
Art. 05.807
□ 12
≠ 12 x 6



Liscio / Smooth
H. 950 X L. 95 mm.
Art. 05.808
□ 12
≠ 12 x 6



Liscio / Smooth
H. 950 X L. 135 mm.
Art. 05.809
□ 12
≠ 12 x 6

Tutte le parti di questo catalogo - foto comprese - sono di proprietà Euro-Fer. La riproduzione, anche parziale, è vietata in ogni forma e con ogni mezzo. / Every part of this catalogue - photos included - is Euro-Fer's property. All forms of copying are strictly prohibited.

🌀 fiori da entrambi i lati / flowers on both sides

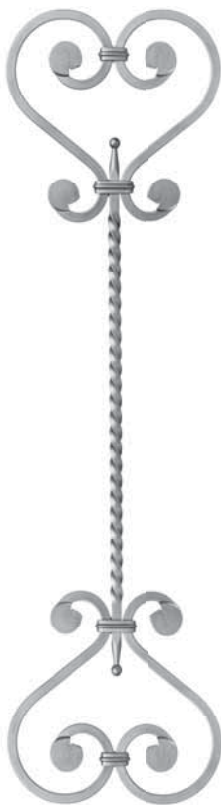

Liscio / Smooth
 H. 820 X L. 220 mm.
Art. 05.810
 □ 10

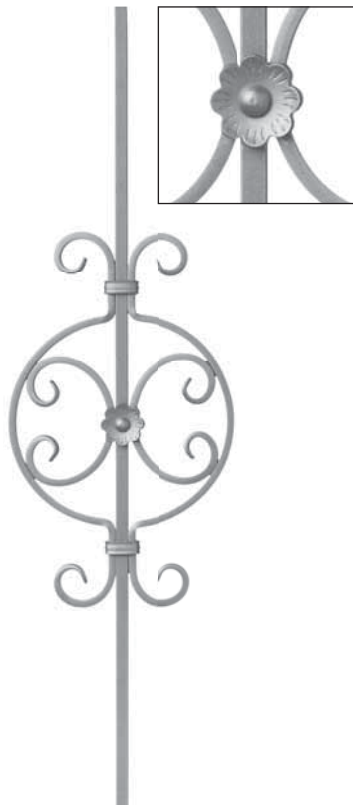

🌀 Liscio / Smooth
 H. 950 X L. 255 mm.
Art. 05.811 □ 14 ≠ 14 x 6
Art. 05.811.01 □ 16 ≠ 16 x 8



Liscio / Smooth
 H. 950 X L. 215 mm.
Art. 05.812
 □ 12 ≠ 12 x 6



Liscio / Smooth
 H. 950 X L. 130 mm.
Art. 05.813
 □ 12 ≠ 12 x 6



🌀 Liscio / Smooth
 H. 950 X L. 95 mm.
Art. 05.825
 □ 12 ≠ 12 x 6

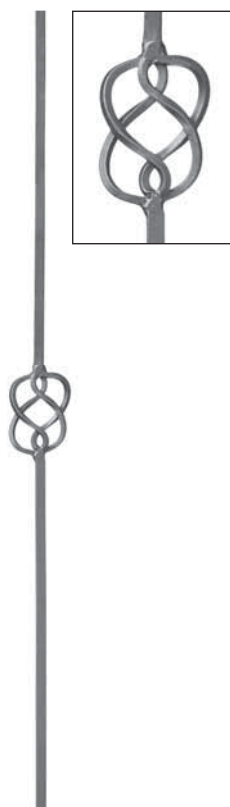

Liscio / Smooth
 H. 1000 X L. 70 mm.
Art. 05.826
 □ 12 pigna / basket □ 12



Liscio / Smooth
 H. 950 X L. 130 mm.
Art. 05.827
 □ 12

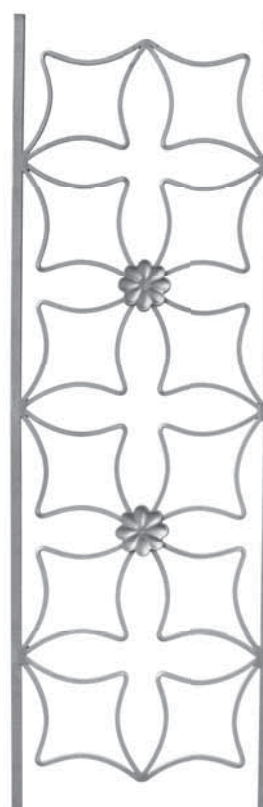

🌀 Liscio / Smooth
 H. 950 X L. 300 mm.
Art. 05.828
 □ 12 ≠ 12 x 6

🌀 fiori da entrambi i lati / flowers on both sides

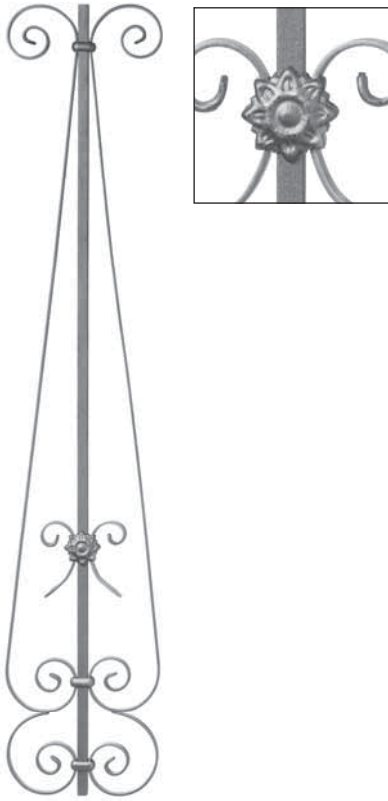

🌀 Liscio / Smooth
H. 1220 X L. 235 mm.
Art. 05.829
□ 16
≠ 16 x 4



Liscio / Smooth
H. 950 X L. 125 mm.
Art. 05.830
□ 12
≠ 12 x 4



Liscio / Smooth
H. 950 X L. 120 mm.
Art. 05.831
□ 12
≠ 12 x 4



Liscio / Smooth
H. 950 X L. 170 mm.
Art. 05.832
□ 12
≠ 12 x 6



H. 100 X L. 100 mm.
Art. 02.050.50 ≠ 14 x 6



H. 110 X L. 110 mm.
Art. 02.050.51 ≠ 12 x 6

H. 200 X L. 200 mm.
Art. 02.051 □ 8 X 8
Art. 02.052 □ 10 X 10
Art. 02.053 □ 12 X 12

H. 80 X L. 80 mm.
Art. 02.050.54 ≠ 12 x 6



H. 110 X L. 110 mm.
Art. 02.050.55 ≠ 12 x 6





H.220 X L.220 mm.
Art. 02.050.56 \neq 12 x 6

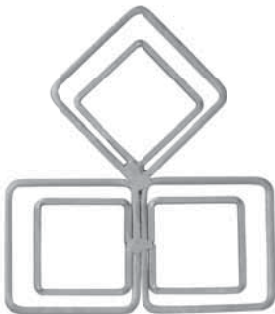

H.250 X L.220 mm.
Art. 02.050.60 \neq 12 x 6



Liscio / Smooth
H. 950 X L. 110 mm.
Art. 05.833
 \square 12
 \neq 12 x 6



Liscio / Smooth
H. 950 X L. 110 mm.
Art. 05.834
 \square 12
 \neq 12 x 6



Liscio / Smooth
H. 950 X L. 110 mm.
Art. 05.835
 \square 12
 \neq 12 x 6



Liscio / Smooth
H. 950 X L. 110 mm.
Art. 05.836
 \square 12
 \neq 12 x 6



Liscio / Smooth
H. 950 X L. 110 mm.
Art. 05.837
 \square 12
 \neq 12 x 6



Liscio / Smooth
H. 950 X L. 110 mm.
Art. 05.838
 \square 12
 \neq 12 x 6



Liscio / Smooth
H. 950 X L. 110 mm.
Art. 05.839
 \square 12
 \neq 12 x 6

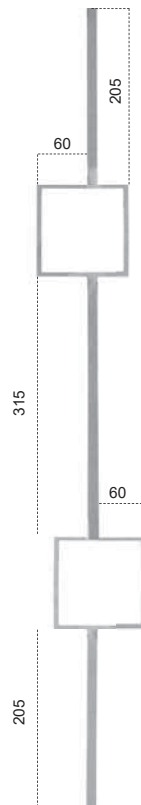

Liscio / Smooth
H. 950 X L. 110 mm.
Art. 05.840
 \square 12
 \neq 12 x 6



Liscio / Smooth
H. 950 X L. 110 mm.
Art. 05.841
 \square 12
 \neq 12 x 6



Liscio / Smooth
H. 950 X L. 220 mm.
Art. 05.842
 \square 12
 \neq 12 x 6

🌀 fiori da entrambi i lati / flowers on both sides



Liscio / Smooth
H. 1000 X L. 183 mm.
Art. 05.843
spessore / thickness 6 mm



Liscio / Smooth
H. 950 X L. 150 mm.
Art. 05.844
□ 12 ≠ 12 x 6



Liscio / Smooth
H. 950 X L. 100 mm.
Art. 05.845
Ø 12



🌀 Liscio / Smooth
H. 950 X L. 100 mm.
Art. 05.846
Ø 12

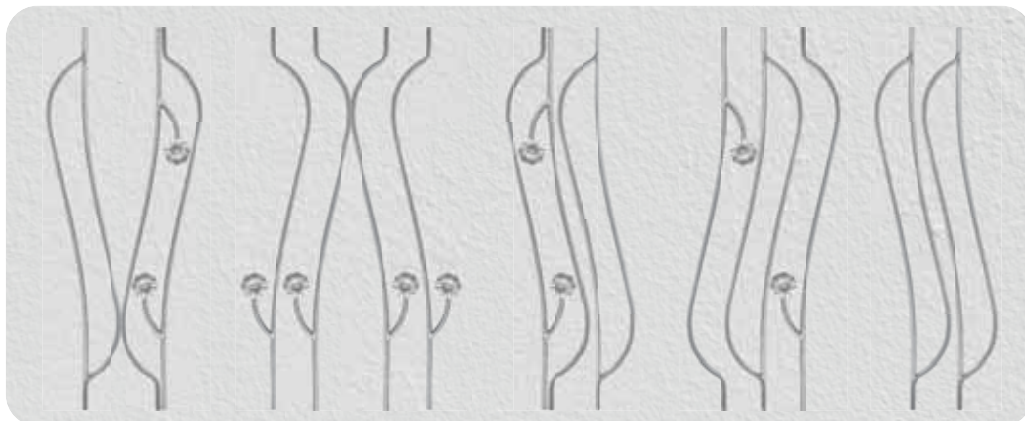



Mart./Hammered
H.950 mm.
Art. 06.001 12
Art. 06.002 14



Mart./Hammered
H.950 mm.
Art. 06.003
 12 X 12



Mart./Hammered
H.950 mm.
Art. 06.004
 12 X 12



Mart./Hammered
H.950 mm.
Art. 06.005
 12 X 12



Mart./Hämmered
H.950 mm.
Art. 06.006
 12 X 12



Mart./Hämmered
H.950 mm.
Art. 06.007
 12 X 12



Mart./Hammered
H.950 mm.
Art. 06.008 12
Art. 06.008.01 14
Art. 06.008.ES 12
Art. 06.008.01.ES 14



Mart./Hammered
H.950 mm.
Art. 06.009 12
Art. 06.009.01 14
Art. 06.009.ES 12
Art. 06.009.01.ES 14



Mart./Hammered
H.950 X L.130 mm.
Art. 06.010
 12 12 X 6



Mart./Hammered
H.950 X L.200 mm.
Art. 06.011
 12 12 X 6



Mart./Hammered
H.950 X L.150 mm.
Art. 06.012
 12 12 X 6
Liscio / Smooth
Art. 06.012.01
 12 12 X 6



Mart./Hammered
H.950 X L.150 mm.
Art. 06.013
 12 12 X 6
Liscio / Smooth
Art. 06.013.01
 12 12 X 6



Mart./Hammered
H.950 X L.140 mm.
Art. 06.014
 12 12 X 6
Art. 06.014.01
 14 14 X 6



Mart./Hammered
H.950 X L.135 mm.
Art. 06.015
 12 12 X 6



Mart./Hammered
H.950 X L.170 mm.
Art. 06.016
 12 12 X 6



Mart./Hammered
H.950 X L.170 mm.
Art. 06.017
 12 12 X 6



Mart./Hammered
H.950 X L.135 mm.
Art. 06.018
 12 12 X 6



Mart./Hammered
H.950 X L.120 mm.
Art. 06.019
 12 12 X 6



Mart./Hammered
H.950 X L.170 mm.
Art. 06.020
 12 12 X 6



Art. 06.021

Fuori Produzione
Out of Production

Tutte le parti di questo catalogo - foto comprese - sono di proprietà Euro-Fer. La riproduzione, anche parziale, è vietata in ogni forma e con ogni mezzo. / Every part of this catalogue - photos included - is Euro-Fer's property. All forms of copying are strictly prohibited.

**PANNELLI MARTELLATI
HAMMERED PANELS**



Mart./Hammered
H.950 X L.165 mm.
Art. 06.023
□12 ≠ 12 X 6



Mart./Hammered
H. 950 X L.165 mm.
Art. 06.024
□12 ≠ 12 x 6 mm



H.950 X L.185 mm.
Art. 06.025
□12 X 12
Mart./Hammered



H.950 X L.160 mm.
Art. 06.026
□12 ≠ 12 X 6
Mart./Hammered

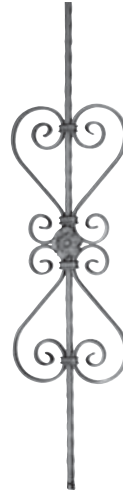

H.950 X L.220 mm.
Art. 06.027
□12 ≠ 12 X 6
Mart./Hammered



H.950 mm.
Art. 06.028
□12 X 12
Mart./Hammered



Mart./Hammered
H.950 X L.150 mm.
Art. 06.029
□12 ≠ 12 X 6



Mart./Hammered
H.950 X L.215 mm.
Art. 06.029.01
□12 ≠ 12 X 6
Art. 06.029.08
□14 ≠ 14 X 6
Art. 06.029.09
□16 ≠ 16 X 6



Mart./Hammered
H.950 X L.275 mm.
Art. 06.029.02
□12 ≠ 12 X 6
Art. 06.029.10
□14 ≠ 14 X 6
Art. 06.029.11
□16 ≠ 16 X 6



Mart./Hammered
H.950 X L.275 mm.
Art. 06.029.03
□12 ≠ 12 X 6
Art. 06.029.12
□14 ≠ 14 X 6
Art. 06.029.13
□16 ≠ 16 X 6



Martellato/Hammered
H.950 X L.115 mm.
Art. 06.029.04
□12 ≠ 12 X 6



Martellato/Hammered
H.950 X L.200 mm.
Art. 06.029.05
□14 ≠ 14 X 6



Martellato/Hammered
H.950 X L.215 mm.
Art. 06.029.06
□14 ≠ 14 X 6



Martellato/Hammered
H.950 X L.205 mm.
Art. 06.029.07
□14 ≠ 14 X 6



Martellato / Hammered
H.950 x L.260 mm
Art. 06.029.14
□12 mm ≠ 12 x 6



Martellato kigato / Hammered Fluted
H.950 x L.210 mm
Art. 06.029.15
□12 mm ≠ 12 x 6



Mart. / Hammered
H.1000 mm.
Art. 06.030 □12
Art. 06.031 □14
Art. 06.032 □16



Liscio / Smooth
H.1000 mm.
Art. 06.030.01 □12
Art. 06.030.02 □14
Art. 06.030.03 □16



Tondo / Round
H.1200 mm.
Art. 06.032.01 Ø 12
Art. 06.032.02 Ø 14
Art. 06.032.03 Ø 16



Liscio / Smooth
H.1200 mm.
Art. 06.032.04 □12
Art. 06.032.05 □14
Art. 06.032.06 □16



Batt. 4 lati/Beaten on 4 sides
H.1200 mm.
Art. 06.032.07 □12
Art. 06.032.08 □14
Art. 06.032.09 □16
H.1500 mm.
Art. 06.032.10 □16

Tutte le parti di questo catalogo - foto comprese - sono di proprietà Euro-Fer. La riproduzione, anche parziale, è vietata in ogni forma e con ogni mezzo. / Every part of this catalogue - photos included - is Euro-Fer's property. All forms of copying are strictly prohibited.



Martellato / Hammered
H.1200 mm.
Art. 06.032.11 □ 12
Art. 06.032.12 □ 14
Art. 06.032.13 □ 16



Martellato / Hammered
H.250 mm.
Art. 06.033 □ 12
Art. 06.034 □ 14
Art. 06.035 □ 16



Tondo / Round
H.250 mm.
Art. 06.035.01 Ø 12
Art. 06.035.02 Ø 14
Art. 06.035.03 Ø 16



H.250 mm.
Art. 06.035.04 □ 12
Art. 06.035.05 □ 14
Art. 06.035.06 □ 16



Battuto 4 lati / Beaten on 4 sides
H.250 mm.
Art. 06.035.07 □ 12
Art. 06.035.08 □ 14
Art. 06.035.09 □ 16



Martellato / Hammered
H.250 mm.
Art. 06.035.10 □ 12
Art. 06.035.11 □ 14
Art. 06.035.12 □ 16



Mart./Hammered
H.950 X L.100 mm.
Art. 06.036
≠ 25 X 12



Mart./Hammered
H.950 X L.100 mm.
Art. 06.037
≠ 25 X 12



Mattone / Brick
H.950 X L.100 mm.
Art. 06.038
≠ 40 X 4



Mattone / Brick
H.950 X L.100 mm.
Art. 06.039
≠ 40 X 4



Martellato / Hammered
H.950 X L.230 mm.
Art. 06.040
□ 12 ≠ 12 X 6
Art. 06.040.01
□ 14 ≠ 14 X 6



Martellato / Hammered
H.950 X L.160 mm.
Art. 06.041
□ 12 ≠ 12 X 6
Art. 06.041.01
□ 14 ≠ 14 X 6



Martellato / Hammered
H.950 X L.160 mm.
Art. 06.042
□ 12 ≠ 12 X 6
Art. 06.042.01
□ 14 ≠ 14 X 6



Martellato / Hammered
H.950 X L.115 mm.
Art. 06.043
□ 12 ≠ 12 X 6
Art. 06.043.01
□ 14 ≠ 14 X 6



Liscio / Smooth
H.950 mm.
Art. 06.044 □ 12
Art. 06.045 □ 14



Martellato / Hammered
H.950 mm.
Art. 06.046 □ 12
Art. 06.047 □ 14



Martellato / Hammered
H.950 mm.
Art. 06.048 □ 12
Art. 06.049 □ 14

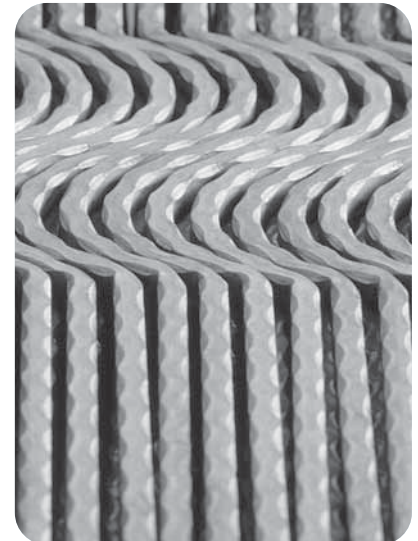

Tutte le parti di questo catalogo - foto comprese - sono di proprietà Euro-Fer. La riproduzione, anche parziale, è vietata in ogni forma e con ogni mezzo. / Every part of this catalogue - photos included - is Euro-Fer's property. All forms of copying are strictly prohibited.



Martellato / Hammered
H.950 X L.170 mm.
Art. 06.050 12
Art. 06.050.01 14



Martellato / Hammered
H.950 X L.155 mm.
Art. 06.051 12
Art. 06.051.01 14



Martellato / Hammered
H.950 X L.155 mm.
Art. 06.052 12
Art. 06.052.01 14



Martellato / Hammered
H.950 X L.200 mm.
Art. 06.053 12
Art. 06.054 14



Martellato / Hammered
H.950 X L.125 mm.
Art. 06.055 12
Art. 06.056 14



Tondo / Round
H.950 mm.
Art. 06.057 \varnothing 12
Art. 06.058 \varnothing 14



Martellato / Hammered
H.1100 mm.
Art. 06.059 20
Art. 06.060 25

Vedi Art. / See Article 11.053.20 / 11.053.21



Martellato / Hammered
H.1000 X L.150 mm.
Art. 06.061 12
Art. 06.062 14



Martellato / Hammered
H.1000 X L.150 mm.
Art. 06.063 12
Art. 06.064 14



H.950 X L.105 mm.
Art. 06.065 12
Art. 06.066 14



H.950 X L.105 mm.
Art. 06.067 12
Art. 06.068 14



Martellato / Hammered
H.950 X L.105 mm.
Art. 06.069 12
Art. 06.070 14



Martellato / Hammered
H.950 X L.105 mm.
Art. 06.071 12
Art. 06.072 14



Martellato / Hammered
H.950 X L.105 mm.
Art. 06.073 12
Art. 06.074 14



Martellato / Hammered
H.950 X L.160 mm.
Art. 06.075 12
Art. 06.076 14



Martellato / Hammered
H.950 mm.
Art. 06.077 14



Martellato / *Hammered*
H.950 X L.100 mm.
Art. 06.078 □ 12



Martellato / *Hammered*
H.950 X L.100 mm.
Art. 06.079 □ 12



Martellato / *Hammered*
H.950 X L.180 mm.
Art. 06.080 □ 12



Martellato / *Hammered*
H.950 X L.260 mm.
Art. 06.081 □ 14



Martellato / *Hammered*
H.950 X L.260 mm.
Art. 06.082 □ 14



Martellato / *Hammered*
H. 1000 X L. 115 mm.
Art. 06.083
□ 12
≠ 12 x 6
Mod. Scala / *Scala Model*





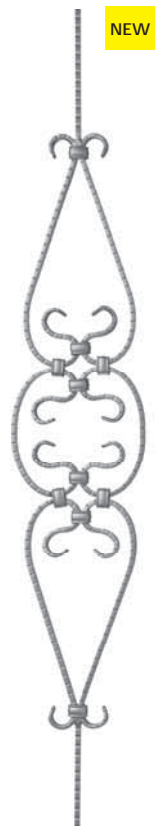



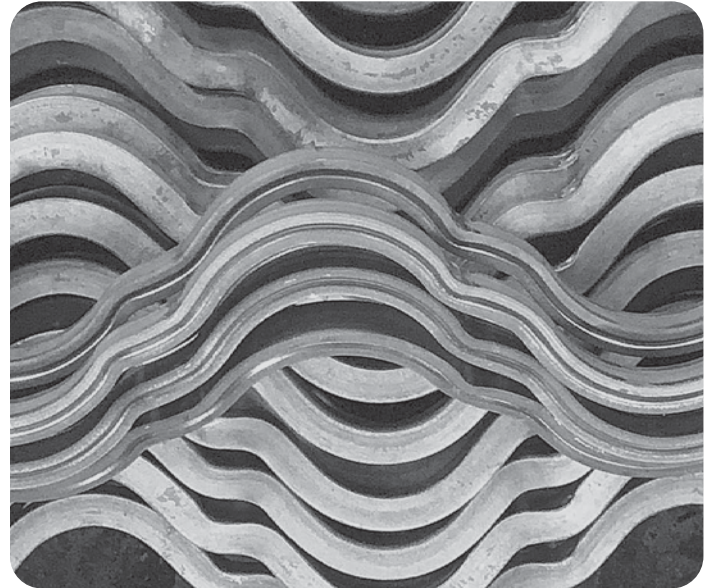
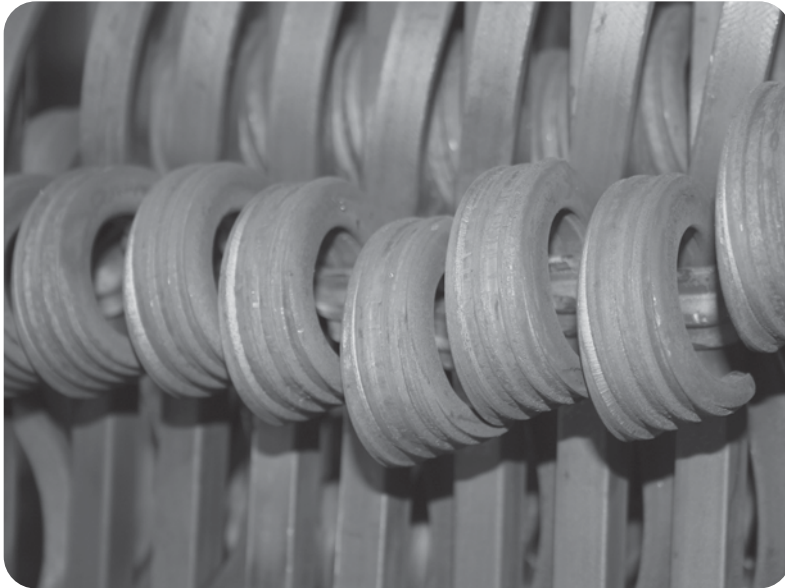





Martellato / *Hammered*
H. 1000 X L. 115 mm.
Art. 06.084
□ 12
≠ 12 x 6
Mod. Scala / *Scala Model*



Mod. Scala / *Scala Model*
H. 950 X L. 145 mm.
Art. 06.085
≠ 16 x 6



 <p>Modello Liquirizia / Liquorice Model</p>	  <p>Modello Liquirizia / Liquorice Model</p>	 <p>Modello Liquirizia / Liquorice Model</p>	 <p>Modello Liquirizia / Liquorice Model</p>	 <p>Modello Liquirizia / Liquorice Model</p>		
<p>H.950 mm.</p> <p>Art. 07.001 <input type="checkbox"/> 12 Art. 07.001.01 <input type="checkbox"/> 14 Art. 07.001.05 <input type="checkbox"/> 16</p>	<p>H.950 mm.</p> <p>Art. 07.001.02 <input type="checkbox"/> 12 Art. 07.001.03 <input type="checkbox"/> 14 Art. 07.001.06 <input type="checkbox"/> 16</p>	<p>Modello Liquirizia / Liquorice Model</p> <p>H.950 mm</p> <p>Art. 07.001.07 <input type="checkbox"/> 12 Art. 07.001.08 <input type="checkbox"/> 14</p>	<p>Modello Liquirizia / Liquorice Model</p> <p>H.950 mm</p> <p>Art. 07.001.09 <input type="checkbox"/> 12 Art. 07.001.10 <input type="checkbox"/> 14</p>	<p>Modello Liquirizia / Liquorice Model</p> <p>H.950 mm</p> <p>Art. 07.001.11 <input type="checkbox"/> 12 Art. 07.001.12 <input type="checkbox"/> 14 Art. 07.001.13 <input type="checkbox"/> 16</p>	<p>H.950 mm.</p> <p>Art. 07.002 <input type="checkbox"/> 12 Art. 07.002.01 <input type="checkbox"/> 14 Art. 07.002.03 <input type="checkbox"/> 16</p>	<p>H.950 mm.</p> <p>Art. 07.003 <input type="checkbox"/> 12 Art. 07.003.01 <input type="checkbox"/> 14 Art. 07.003.06 <input type="checkbox"/> 16</p>

	  <p>Particolare rigato Fluted detail</p>				
<p>H.950 mm.</p> <p>Art. 07.002.02 <input type="checkbox"/> 12 \neq 16 x 8</p>	<p>H.950 mm.</p> <p>Art. 07.003.02 <input type="checkbox"/> 12 \neq 16 x 8</p>	<p>H.950 mm.</p> <p>Art. 07.003.05 <input type="checkbox"/> 12 \neq 16 x 8</p>	<p>H.950 X L.140 mm.</p> <p>Art. 07.004 <input type="checkbox"/> 12 \neq 12 X 6</p>	<p>H.950 X L.140 mm.</p> <p>Art. 07.005 <input type="checkbox"/> 12 \neq 12 X 6</p>	<p>H.950 X L.100</p> <p>Art. 07.006 <input type="checkbox"/> 12</p>

Tutte le parti di questo catalogo - foto comprese - sono di proprietà Euro-Fer. La riproduzione, anche parziale, è vietata in ogni forma e con ogni mezzo. / Every part of this catalogue - photos included - is Euro-Fer's property. All forms of copying are strictly prohibited.



H.950 X L.105 mm.
Art. 07.007 □ 12



H.950 X L.115 mm.
Art. 07.007.01 □ 12



H.950 mm.
Art. 07.008 □ 12



H.950 mm.
Art. 07.009 □ 12



H.950 X L.165 mm.
Art. 07.010
□ 12 ≠ 12 X 6



H.950 X L.165 mm.
Art. 07.011
□ 12 ≠ 12 X 6



H.950 X L.145 mm.
Art. 07.012
□ 12 ≠ 12 X 6



H.950 X L.70 mm.
Art. 07.013 □ 12



H.950 X L.190 mm.
Art. 07.014
□ 12 ≠ 12 X 6



H.950 X L.145 mm.
Art. 07.015
□ 12 ≠ 12 X 6



H.950 X L.215 mm.
Art. 07.016
□ 12 ≠ 12 X 6



H.950 X L.170 mm.
Art. 07.017
□ 12 ≠ 12 X 6



H.950 X L.140 mm.
Art. 07.018
□ 12 ≠ 12 X 6



H.950 X L.230 mm.
Art. 07.019
□ 12 ≠ 12 X 6
Art. 07.019.01
□ 14 ≠ 14 X 6



Liscio / Smooth
H.950 x L.230 mm
Art. 07.019.02 □ 12
Art. 07.019.03 □ 14



H.950 X L.205 mm.
Art. 07.020
□ 12 ≠ 12 X 6
Art. 07.020.01
□ 14 ≠ 14 X 6



H.950 X L.145 mm.
Art. 07.021
□ 12 ≠ 12 X 6



H.850 X L.200 mm.
Art. 07.022
□ 12 ≠ 12 X 6



H.850 X L.200 mm.
Art. 07.023
□ 12 ≠ 12 X 6

Tutte le parti di questo catalogo - foto comprese - sono di proprietà Euro-Fer. La riproduzione, anche parziale, è vietata in ogni forma e con ogni mezzo. / Every part of this catalogue - photos included - is Euro-Fer's property. All forms of copying are strictly prohibited.

PANNELLI RIGATI CON PROFILO A NUVOLA
FLUTED PANELS "CLOUD"

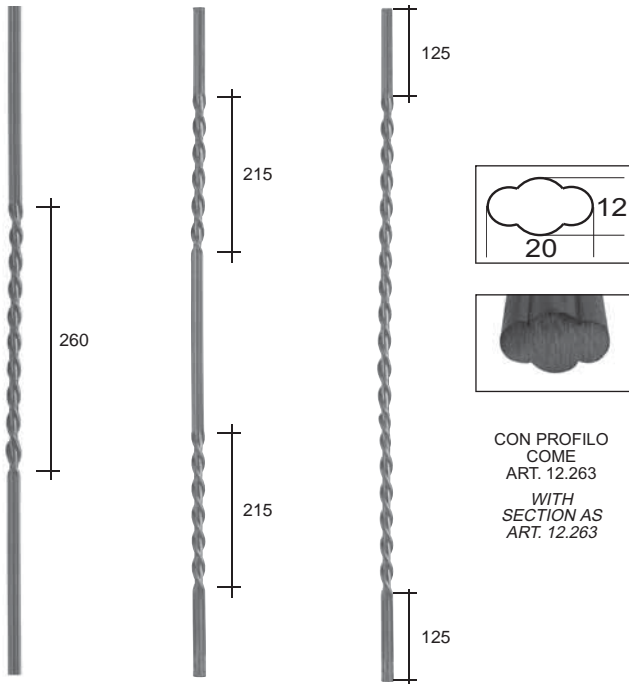

CON PROFILO
COME
ART. 12.263
WITH
SECTION AS
ART. 12.263

Rigato / Fluted
H.950 mm.
Art. 07.050
20 x 12

Rigato / Fluted
H.950 mm.
Art. 07.051
20 x 12

Rigato / Fluted
H.950 mm.
Art. 07.052
20 x 12



Rigato / Fluted
H.950 x L.100 mm
Art. 05.591 □ 14
Art. 05.591.01 □ 12
Con fiori su ambo i lati /
Flowers on both sides



H.900 mm
Art. 07.060 2 x Ø 8



H.900 mm
Art. 07.061 2 x Ø 8



H.900 x L.120 mm
Art. 07.064 2 x Ø 8



Rigato / Fluted
H. 950 X L. 120 mm.
Art. 07.066
□ 12
≠ 12 x 6



Rigato / Fluted
H. 950 X L. 120 mm.
Art. 07.067
□ 12
≠ 12 x 6



Tubo Liscio /
Smooth Tube
H.900 mm
Art. TB.21.900 Ø 30



Tubo Liscio /
Smooth Tube
H.900 mm
Art. TB.21.901 Ø 30



Tubo Liscio /
Smooth Tube
H.900 mm
Art. TB.21.902 Ø 30



Tubo Liscio /
Smooth Tube
H.900 mm
Art. TB.21.903 Ø 30



Tubo Liscio /
Smooth Tube
H.1200 mm
Art. TB.24.400 Ø 40

Tutte le parti di questo catalogo - foto comprese - sono di proprietà Euro-Fer. La riproduzione, anche parziale, è vietata in ogni forma e con ogni mezzo. / Every part of this catalogue - photos included - is Euro-Fer's property. All forms of copying are strictly prohibited.



sezione ferro iron section	tipo ferro iron type	codice code	interasse centre distance	nr. fori nr. of holes	tipo fori kind of holes	luce hole to hole	trattamento finishing
■ 12x12	liscio / smooth	08.006.01	120 mm	16 fori / holes	□ 12x12	108 mm	grezzo / raw
■ 14x14	liscio / smooth	08.119	125 mm	15 fori / holes	□ 14x14	111 mm	grezzo / raw
■ 14x14	liscio / smooth ES	08.119.01	125 mm	14 fori / holes	□ 14x14	111 mm.	grezzo / raw
■ 14x14	liscio / smooth	08.001	140 mm	14 fori / holes	□ 14x14	126 mm	grezzo / raw
■ 16x16	liscio / smooth	08.120	125 mm	15 fori / holes	□ 16x16	109 mm	grezzo / raw
■ 16x16	liscio / smooth	08.131	125 mm	15 fori / holes	□ 14x14	111 mm	grezzo / raw
■ 16x16	liscio / smooth ES	08.120.01	135 mm	14 fori / holes	□ 16x16	119 mm	grezzo / raw
■ 16x16	liscio / smooth	08.002	150 mm	13 fori / holes	□ 16x16	134 mm	grezzo / raw
■ 18x18	liscio / smooth	08.121	128 mm	14 fori / holes	□ 18x18	110 mm	grezzo / raw
■ 18x18	liscio / smooth	08.003	160 mm	12 fori / holes	□ 18x18	142 mm	grezzo / raw
■ 20x20	liscio / smooth	08.122	130 mm	13 fori / holes	□ 20x20	110 mm	grezzo / raw
■ 20x20	liscio / smooth	08.004	170 mm	11 fori / holes	□ 20x20	150 mm	grezzo / raw
■ 22x22	liscio / smooth	08.005	170 mm	11 fori / holes	□ 22x22	148 mm	grezzo / raw
■ 25x25	liscio / smooth	08.006	180 mm	10 fori / holes	□ 25x25	155 mm	grezzo / raw

lunghezza standard 2000 mm.
standard size 2000 mm.

- quadro / square
- ◇ foro quadro in obliquo / slanting square hole
- ∅ tondo / round
- ∅ foro ovale / oval hole
- foro rettangolo / rectangular hole
- ES foro largo / larger hole

Riassunto barre forate in ordine di codice a pag. 261
Summary holed bars in order of code on pag. 261

Tutte le parti di questo catalogo - foto comprese - sono di proprietà Euro-Fer. La riproduzione, anche parziale, è vietata in ogni forma e con ogni mezzo. / Every part of this catalogue - photos included - is Euro-Fer's property. All forms of copying are strictly prohibited.



sezione ferro iron section	tipo ferro iron type	codice code	interasse centre distance	nr. fori nr. of holes	tipo fori kind of holes	luce hole to hole	trattamento finishing
■ 14x14	liscio / smooth	08.123	128 mm	14 fori / holes	◇14x14 sullo spigolo / on the edge	108 mm	grezzo / raw
■ 14x14	liscio / smooth	08.007	140 mm	14 fori / holes	◇14x14 sullo spigolo / on the edge	120 mm	grezzo / raw
■ 16x16	liscio / smooth	08.124	130 mm	14 fori / holes	◇16x16 sullo spigolo / on the edge	107 mm	grezzo / raw
■ 16x16	liscio / smooth	08.008	150 mm	13 fori / holes	◇16x16 sullo spigolo / on the edge	127 mm	grezzo / raw
■ 18x18	liscio / smooth	08.125	132 mm	14 fori / holes	◇18x18 sullo spigolo / on the edge	107 mm	grezzo / raw
■ 18x18	liscio / smooth	08.009	160 mm	12 fori / holes	◇18x18 sullo spigolo / on the edge	135 mm	grezzo / raw
■ 20x20	liscio / smooth	08.126	134 mm	13 fori / holes	◇20x20 sullo spigolo / on the edge	106 mm	grezzo / raw
■ 20x20	liscio / smooth	08.010	170 mm	11 fori / holes	◇20x20 sullo spigolo / on the edge	142 mm	grezzo / raw
■ 22x22	liscio / smooth	08.011	170 mm	11 fori / holes	◇22x22 sullo spigolo / on the edge	139 mm	grezzo / raw
■ 25x25	liscio / smooth	08.012	180 mm	10 fori / holes	◇25x25 sullo spigolo / on the edge	145 mm	grezzo / raw



■ 14x14	liscio / smooth	08.127	128 mm	14 fori / holes	◇14x14	108 mm	grezzo / raw
■ 14x14	liscio / smooth	ES 08.127.01	135 mm	14 fori / holes	◇14x14	115 mm	grezzo / raw
■ 14x14	liscio / smooth	08.013	140 mm	14 fori / holes	◇14x14	120 mm	grezzo / raw
■ 16x16	liscio / smooth	ES 08.128.02	125 mm	15 fori / holes	◇16x16	102 mm	grezzo / raw
■ 16x16	liscio / smooth	08.128	130 mm	14 fori / holes	◇16x16	107 mm	grezzo / raw
■ 16x16	liscio / smooth	ES 08.128.01	135 mm	14 fori / holes	◇16x16	112 mm	grezzo / raw
■ 16x16	liscio / smooth	08.014	150 mm	13 fori / holes	◇16x16	127 mm	grezzo / raw
■ 18x18	liscio / smooth	08.129	132 mm	14 fori / holes	◇18x18	107 mm	grezzo / raw
■ 18x18	liscio / smooth	ES 08.129.01	135 mm	14 fori / holes	◇18x18	110 mm	grezzo / raw
■ 18x18	liscio / smooth	08.015	160 mm	12 fori / holes	◇18x18	135 mm	grezzo / raw
■ 20x20	liscio / smooth	08.130	135 mm	13 fori / holes	◇20x20	107 mm	grezzo / raw
■ 20x20	liscio / smooth	08.016	170 mm	11 fori / holes	◇20x20	142 mm	grezzo / raw
■ 22x22	liscio / smooth	08.017	170 mm	11 fori / holes	◇22x22	139 mm	grezzo / raw
■ 25x25	liscio / smooth	08.018	180 mm	10 fori / holes	◇25x25	145 mm	grezzo / raw



Ø 14	liscio / smooth	08.019	140 mm	14 fori / holes	θ 14x26 mm ovale / oval		grezzo / raw
Ø 16	liscio / smooth	08.020	150 mm	13 fori / holes	θ 16x28 mm ovale / oval		grezzo / raw
Ø 18	liscio / smooth	08.021	160 mm	12 fori / holes	θ 18x30 mm ovale / oval		grezzo / raw
Ø 20	liscio / smooth	08.022	170 mm	11 fori / holes	θ 20x33 mm ovale / oval		grezzo / raw

lunghezza standard 2000 mm.
standard size 2000 mm.

□	quadro / square
◇	foro quadro in obliquo / slanting square hole
Ø	tondo / round
θ	foro ovale / oval hole
▭	foro rettangolo / rectangular hole
ES	foro largo / larger hole

Riassunto barre forate in ordine di codice a pag. 261
Summary holed bars in order of code on pag. 261



sezione ferro iron section	tipo ferro iron type	codice code	interasse centre distance	nr. fori nr. of holes	tipo fori kind of holes	luce hole to hole	trattamento finishing
Ø 12	liscio / smooth	08.029.01	120 mm	16 fori / holes	Ø 12	108 mm	grezzo / raw
Ø 14	liscio / smooth	08.115	125 mm	15 fori / holes	Ø 14	111 mm	grezzo / raw
Ø 14	liscio / smooth	08.115.01	130 mm	14 fori / holes	Ø 14	116 mm	grezzo / raw
Ø 14	liscio / smooth	08.023	140 mm	14 fori / holes	Ø 14	126 mm	grezzo / raw
Ø 16	liscio / smooth	08.116	125 mm	15 fori / holes	Ø 16	109 mm	grezzo / raw
Ø 16	liscio / smooth	08.132	125 mm	15 fori / holes	Ø 14	111 mm	grezzo / raw
Ø 16	liscio / smooth	08.024	150 mm	13 fori / holes	Ø 16	126 mm	grezzo / raw
Ø 16	liscio / smooth	08.116.01	160 mm	12 fori / holes	Ø 16	144 mm	grezzo / raw
Ø 18	liscio / smooth	08.117	128 mm	14 fori / holes	Ø 18	110 mm	grezzo / raw
Ø 18	liscio / smooth	08.025	160 mm	12 fori / holes	Ø 18	142 mm	grezzo / raw
Ø 20	liscio / smooth	08.118	130 mm	13 fori / holes	Ø 20	110 mm	grezzo / raw
Ø 20	liscio / smooth	08.026	170 mm	11 fori / holes	Ø 20	150 mm	grezzo / raw
Ø 22	liscio / smooth	08.027	170 mm	11 fori / holes	Ø 22	148 mm	grezzo / raw
Ø 25	liscio / smooth	08.028	180 mm	10 fori / holes	Ø 25	155 mm	grezzo / raw
Ø 30	liscio / smooth	08.029	200 mm	9 fori / holes	Ø 30	170 mm	grezzo / raw



■ 14x14	liscio / smooth	08.106	140 mm	14 fori / holes	□ 24x15 rettangolo / rectangular		grezzo / raw
■ 16x16	liscio / smooth	08.107	150 mm	13 fori / holes	□ 30x17 rettangolo / rectangular		grezzo / raw
■ 18x18	liscio / smooth	08.108	160 mm	12 fori / holes	□ 31x19 rettangolo / rectangular		grezzo / raw
■ 20x20	liscio / smooth	08.109	170 mm	11 fori / holes	□ 33x21 rettangolo / rectangular		grezzo / raw



Ø 14	corteccia / bark	08.130.01	125 mm	15 fori / holes	Ø 14	111 mm	grezzo / raw
Ø 14	corteccia / bark	08.109.01	140 mm	14 fori / holes	Ø 14	126 mm	grezzo / raw
Ø 16	corteccia / bark	08.130.02	125 mm	15 fori / holes	Ø 16	109 mm	grezzo / raw
Ø 16	corteccia / bark	08.109.02	150 mm	13 fori / holes	Ø 16	126 mm	grezzo / raw
Ø 18	corteccia / bark	08.130.03	128 mm	14 fori / holes	Ø 18	110 mm	grezzo / raw
Ø 18	corteccia / bark	08.109.03	160 mm	12 fori / holes	Ø 18	142 mm	grezzo / raw
Ø 20	corteccia / bark	08.109.04	170 mm	11 fori / holes	Ø 20	150 mm	grezzo / raw
Ø 22	corteccia / bark	08.109.05	170 mm	11 fori / holes	Ø 22	148 mm	grezzo / raw

lunghezza standard 2000 mm.
standard size 2000 mm.

- quadro / square
- ◇ foro quadro in obliquo / slanting square hole
- Ø tondo / round
- ∅ foro ovale / oval hole
- foro rettangolo / rectangular hole
- ES foro largo / larger hole

Riassunto barre forate in ordine di codice a pag. 261
Summary holed bars in order of code on pag. 261



sezione ferro <i>iron section</i>	tipo ferro <i>iron type</i>	codice <i>code</i>	interasse <i>centre distance</i>	nr. fori <i>nr. of holes</i>	tipo fori <i>kind of holes</i>	luce <i>hole to hole</i>	trattamento <i>finishing</i>
■ 12x12	martellato / hammered	08.110	120 mm	16 fori / holes	□ 12x12	108 mm	grezzo / raw
■ 14x14	martellato / hammered	08.111	140 mm	14 fori / holes	□ 14x14	126 mm	grezzo / raw
■ 16x16	martellato / hammered	08.112	150 mm	13 fori / holes	□ 16x16	134 mm	grezzo / raw
■ 18x18	martellato / hammered	08.113	160 mm	12 fori / holes	□ 18x18	142 mm	grezzo / raw
■ 20x20	martellato / hammered	08.114	170 mm	11 fori / holes	□ 20x20	150 mm	grezzo / raw



■ 14x14	corteccia / bark	08.114.01	140 mm	14 fori / holes	□ 14x14	126 mm	grezzo / raw
■ 16x16	corteccia / bark	08.114.02	150 mm	13 fori / holes	□ 16x16	134 mm	grezzo / raw



■ 14x14	corteccia / bark	08.114.10	140 mm	14 fori / holes	◇ 14x14	120 mm	grezzo / raw
■ 16x16	corteccia / bark	08.114.11	150 mm	13 fori / holes	◇ 16x16	127 mm	grezzo / raw



■ 14x14	martellato / hammered	08.114.20	140 mm	14 fori / holes	◇ 14x14 sullo spigolo / on the edge	120 mm	grezzo / raw
■ 16x16	martellato / hammered	08.114.21	150 mm	13 fori / holes	◇ 16x16 sullo spigolo / on the edge	127 mm	grezzo / raw



■ 12x12	in spigolo / edged	08.114.30	120 mm	16 fori / holes	□ 12x12	108 mm	grezzo / raw
■ 14x14	in spigolo / edged	08.114.31	140 mm	14 fori / holes	□ 14x14	126 mm	grezzo / raw
■ 16x16	in spigolo / edged	08.114.32	150 mm	13 fori / holes	□ 16x16	134 mm	grezzo / raw
■ 18x18	in spigolo / edged	08.114.33	160 mm	12 fori / holes	□ 18x18	142 mm	grezzo / raw

lunghezza standard 2000 mm.
standard size 2000 mm.

□	quadro / square
◇	foro quadro in obliquo / slanting square hole
∅	tondo / round
∅	foro ovale / oval hole
□	foro rettangolo / rectangular hole
ES	foro largo / larger hole

Riassunto barre forate in ordine di codice a pag. 261
Summary holed bars in order of code on pag. 261



BARRE FORATE SABBiate / SANDBLASTED HOLED BARS

sezione ferro <i>iron section</i>	tipo ferro <i>iron type</i>	codice <i>code</i>	interasse <i>centre distance</i>	nr. fori <i>nr. of holes</i>	tipo fori <i>kind of holes</i>	luce <i>hole to hole</i>	trattamento <i>finishing</i>
■ 12x12	liscio / smooth	08.133	120 mm	16 fori / holes	□ 12x12	108 mm	sabbiato / sandblasted
■ 14x14	liscio / smooth	08.168	125 mm	15 fori / holes	□ 14x14	111 mm	sabbiato / sandblasted
■ 14x14	liscio / smooth ES	08.168.01	125 mm	14 fori / holes	□ 14x14	111 mm.	sabbiato / sandblasted
■ 14x14	liscio / smooth	08.134	140 mm	14 fori / holes	□ 14x14	126 mm	sabbiato / sandblasted
■ 16x16	liscio / smooth	08.169	125 mm	15 fori / holes	□ 16x16	109 mm	sabbiato / sandblasted
■ 16x16	liscio / smooth	08.180	125 mm	15 fori / holes	□ 14x14	111 mm	sabbiato / sandblasted
■ 16x16	liscio / smooth ES	08.169.01	135 mm	14 fori / holes	□ 16x16	119 mm	sabbiato / sandblasted
■ 16x16	liscio / smooth	08.135	150 mm	13 fori / holes	□ 16x16	134 mm	sabbiato / sandblasted
■ 18x18	liscio / smooth	08.170	128 mm	14 fori / holes	□ 18x18	110 mm	sabbiato / sandblasted
■ 18x18	liscio / smooth	08.136	160 mm	12 fori / holes	□ 18x18	142 mm	sabbiato / sandblasted
■ 20x20	liscio / smooth	08.171	130 mm	13 fori / holes	□ 20x20	110 mm	sabbiato / sandblasted
■ 20x20	liscio / smooth	08.137	170 mm	11 fori / holes	□ 20x20	150 mm	sabbiato / sandblasted
■ 22x22	liscio / smooth	08.138	170 mm	11 fori / holes	□ 22x22	148 mm	sabbiato / sandblasted
■ 25x25	liscio / smooth	08.139	180 mm	10 fori / holes	□ 25x25	155 mm	sabbiato / sandblasted



BARRE FORATE SABBiate / SANDBLASTED HOLED BARS

■ 14x14	liscio / smooth	08.172	128 mm	14 fori / holes	◇ 14x14 sullo spigolo / on the edge	108 mm	sabbiato / sandblasted
■ 14x14	liscio / smooth	08.140	140 mm	14 fori / holes	◇ 14x14 sullo spigolo / on the edge	120 mm	sabbiato / sandblasted
■ 16x16	liscio / smooth	08.173	130 mm	14 fori / holes	◇ 16x16 sullo spigolo / on the edge	107 mm	sabbiato / sandblasted
■ 16x16	liscio / smooth	08.141	150 mm	13 fori / holes	◇ 16x16 sullo spigolo / on the edge	127 mm	sabbiato / sandblasted
■ 18x18	liscio / smooth	08.174	132 mm	14 fori / holes	◇ 18x18 sullo spigolo / on the edge	107 mm	sabbiato / sandblasted
■ 18x18	liscio / smooth	08.142	160 mm	12 fori / holes	◇ 18x18 sullo spigolo / on the edge	135 mm	sabbiato / sandblasted
■ 20x20	liscio / smooth	08.175	134 mm	13 fori / holes	◇ 20x20 sullo spigolo / on the edge	106 mm	sabbiato / sandblasted
■ 20x20	liscio / smooth	08.143	170 mm	11 fori / holes	◇ 20x20 sullo spigolo / on the edge	142 mm	sabbiato / sandblasted
■ 22x22	liscio / smooth	08.144	170 mm	11 fori / holes	◇ 22x22 sullo spigolo / on the edge	139 mm	sabbiato / sandblasted
■ 25x25	liscio / smooth	08.145	180 mm	10 fori / holes	◇ 25x25 sullo spigolo / on the edge	145 mm	sabbiato / sandblasted

lunghezza standard 2000 mm.
standard size 2000 mm.

- quadro / square
- ◇ foro quadro in obliquo / slanting square hole
- ∅ tondo / round
- ∅ foro ovale / oval hole
- foro rettangolo / rectangular hole
- ES foro largo / larger hole

Riassunto barre forate in ordine di codice a pag. 261
Summary holed bars in order of code on pag. 261



BARRE FORATE SABBIASTE / SANDBLASTED HOLED BARS

sezione ferro iron section	tipo ferro iron type	codice code	interasse centre distance	nr. fori nr. of holes	tipo fori kind of holes	luce hole to hole	trattamento finishing
■ 14x14	liscio / smooth	08.176	128 mm	14 fori / holes	◇14x14	108 mm	sabbiato / sandblasted
■ 14x14	liscio / smooth ES	08.176.01	135 mm	14 fori / holes	◇14x14	115 mm	sabbiato / sandblasted
■ 14x14	liscio / smooth	08.146	140 mm	14 fori / holes	◇14x14	120 mm	sabbiato / sandblasted
■ 16x16	liscio / smooth ES	08.177.02	125 mm	15 fori / holes	◇16x16	102 mm	sabbiato / sandblasted
■ 16x16	liscio / smooth	08.177	130 mm	14 fori / holes	◇16x16	107 mm	sabbiato / sandblasted
■ 16x16	liscio / smooth ES	08.177.01	135 mm	14 fori / holes	◇16x16	112 mm	sabbiato / sandblasted
■ 16x16	liscio / smooth	08.147	150 mm	13 fori / holes	◇16x16	127 mm	sabbiato / sandblasted
■ 18x18	liscio / smooth	08.178	132 mm	14 fori / holes	◇18x18	107 mm	sabbiato / sandblasted
■ 18x18	liscio / smooth ES	08.178.01	135 mm	14 fori / holes	◇18x18	110 mm	sabbiato / sandblasted
■ 18x18	liscio / smooth	08.148	160 mm	12 fori / holes	◇18x18	135 mm	sabbiato / sandblasted
■ 20x20	liscio / smooth	08.179	135 mm	13 fori / holes	◇20x20	107 mm	sabbiato / sandblasted
■ 20x20	liscio / smooth	08.149	170 mm	11 fori / holes	◇20x20	142 mm	sabbiato / sandblasted
■ 22x22	liscio / smooth	08.150	170 mm	11 fori / holes	◇22x22	139 mm	sabbiato / sandblasted
■ 25x25	liscio / smooth	08.151	180 mm	10 fori / holes	◇25x25	145 mm	sabbiato / sandblasted



BARRE FORATE SABBIASTE / SANDBLASTED HOLED BARS

Ø 14	liscio / smooth	08.152	140 mm	14 fori / holes	∅ 14x26 mm ovale / oval		sabbiato / sandblasted
Ø 16	liscio / smooth	08.153	150 mm	13 fori / holes	∅ 16x28 mm ovale / oval		sabbiato / sandblasted
Ø 18	liscio / smooth	08.154	160 mm	12 fori / holes	∅ 18x30 mm ovale / oval		sabbiato / sandblasted
Ø 20	liscio / smooth	08.155	170 mm	11 fori / holes	∅ 20x33 mm ovale / oval		sabbiato / sandblasted



BARRE FORATE SABBIASTE / SANDBLASTED HOLED BARS

Ø 12	liscio / smooth	08.156	120 mm	16 fori / holes	Ø 12	108 mm	sabbiato / sandblasted
Ø 14	liscio / smooth	08.164	125 mm	15 fori / holes	Ø 14	111 mm	sabbiato / sandblasted
Ø 14	liscio / smooth	08.164.01	130 mm	14 fori / holes	Ø 14	116 mm	sabbiato / sandblasted
Ø 14	liscio / smooth	08.157	140 mm	14 fori / holes	Ø 14	126 mm	sabbiato / sandblasted
Ø 16	liscio / smooth	08.165	125 mm	15 fori / holes	Ø 16	109 mm	sabbiato / sandblasted
Ø 16	liscio / smooth	08.181	125 mm	15 fori / holes	Ø 14	111 mm	sabbiato / sandblasted
Ø 16	liscio / smooth	08.158	150 mm	13 fori / holes	Ø 16	126 mm	sabbiato / sandblasted
Ø 16	liscio / smooth	08.165.01	160 mm	12 fori / holes	Ø 16	144 mm	sabbiato / sandblasted
Ø 18	liscio / smooth	08.166	128 mm	14 fori / holes	Ø 18	110 mm	sabbiato / sandblasted
Ø 18	liscio / smooth	08.159	160 mm	12 fori / holes	Ø 18	142 mm	sabbiato / sandblasted
Ø 20	liscio / smooth	08.167	130 mm	13 fori / holes	Ø 20	110 mm	sabbiato / sandblasted
Ø 20	liscio / smooth	08.160	170 mm	11 fori / holes	Ø 20	150 mm	sabbiato / sandblasted
Ø 22	liscio / smooth	08.161	170 mm	11 fori / holes	Ø 22	148 mm	sabbiato / sandblasted
Ø 25	liscio / smooth	08.162	180 mm	10 fori / holes	Ø 25	155 mm	sabbiato / sandblasted
Ø 30	liscio / smooth	08.163	200 mm	9 fori / holes	Ø 30	170 mm	sabbiato / sandblasted

BARRE FORATE HOLED BARS

Palline Grandi / Large Balls

INTERASSE / CENTRE DISTANCE 135 mm.

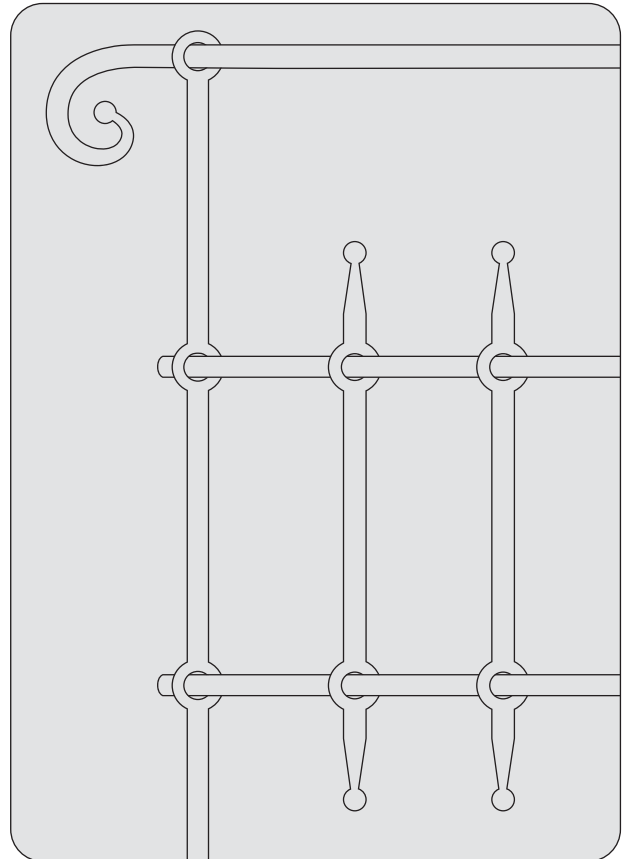
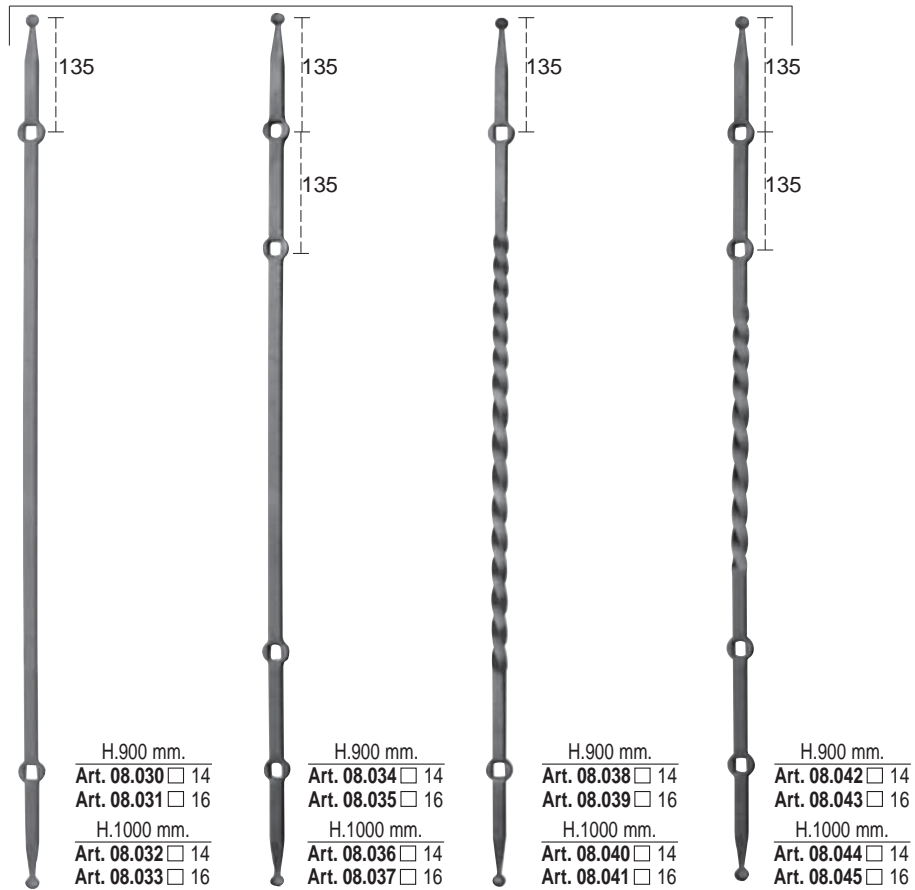

ZF ARTICOLI ZINCATI A FREDDO
COLD GALVANIZED ARTICLES

Per le barre forate Zincate a Freddo andare a pag. 261 del Catalogo.
See our Cold Galvanized holed bars at pag. 261 of the Catalogue.

Tutte le parti di questo catalogo - foto comprese - sono di proprietà Euro-Fer. La riproduzione, anche parziale, è vietata in ogni forma e con ogni mezzo. / Every part of this catalogue - photos included - is Euro-Fer's property. All forms of copying are strictly prohibited.

FORO TONDO / ROUND HOLE

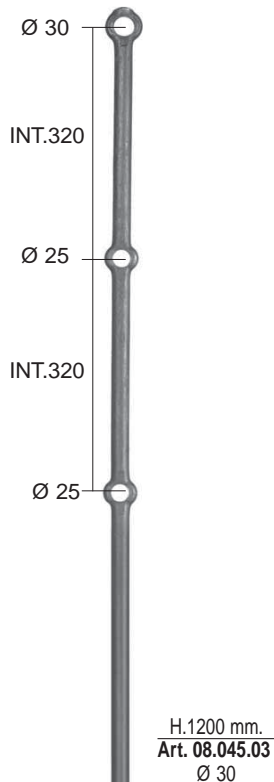
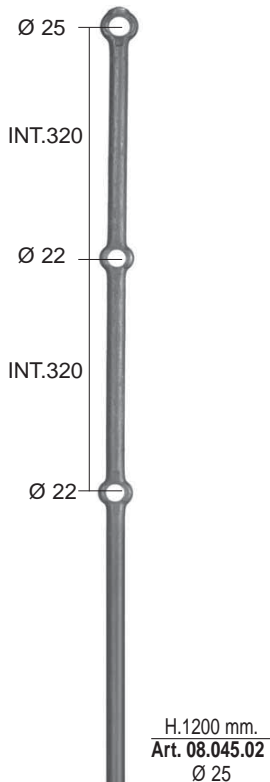
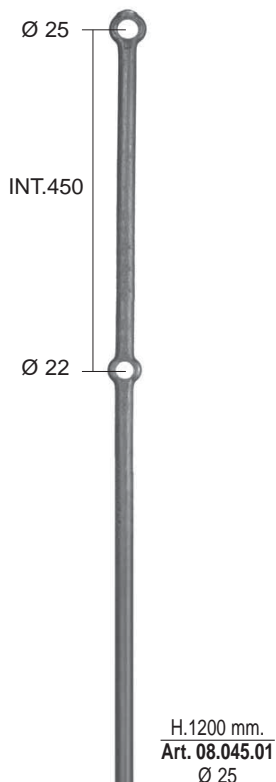

FORO OVALE / OVAL HOLE

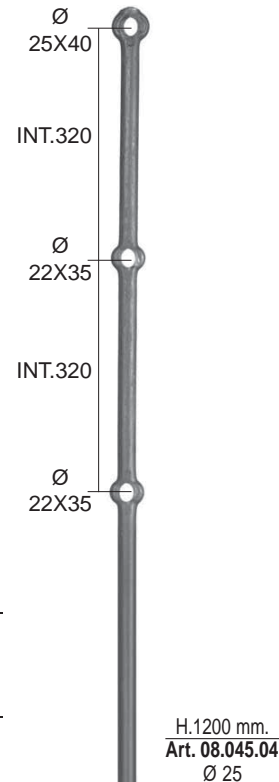

G: grezzo / raw
 S: sabbiato / sandblasted

NEW

FORO OVALE
 OVAL HOLE



NEW



- H. 740 X L. 120 mm.
Art. 08.045.45G
Art. 08.045.45S
 Ø 20
- H. 740 X L. 125 mm.
Art. 08.045.46G
Art. 08.045.46S
 Ø 22
- H. 740 X L. 130 mm.
Art. 08.045.47G
Art. 08.045.47S
 Ø 25
- H. 740 X L. 145 mm.
Art. 08.045.48G
Art. 08.045.48S
 Ø 30

FORO TONDO
 ROUND HOLE

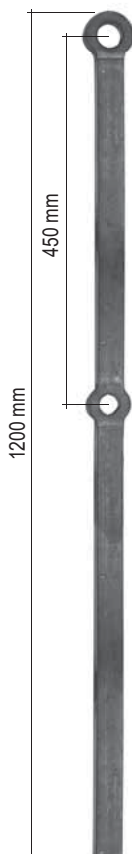

- Liscio / Smooth
 H.1200 mm
Art. 08.045.30 □ 30 X 30 mm
 Foro alto / Top hole Ø 30 mm
 Foro basso / Down hole Ø 25 mm
- Art. 08.045.32** □ 30 X 30 mm
 Foro alto / Top hole Ø 25 mm
 Foro basso / Down hole Ø 22 mm

FORO QUADRO IN OBLIQUO
 SLATING SQUARE HOLE

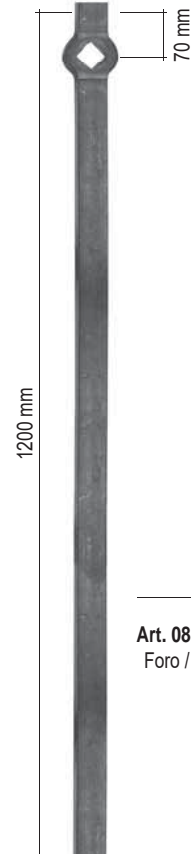

- Liscio / Smooth
 H.1200 mm
Art. 08.045.50 □ 30 X 30 mm
 Foro / Hole ◊ 30 X 30 mm

Tutte le parti di questo catalogo - foto comprese - sono di proprietà Euro-Fer. La riproduzione, anche parziale, è vietata in ogni forma e con ogni mezzo. / Every part of this catalogue - photos included - is Euro-Fer's property. All forms of copying are strictly prohibited.

**BARRE FORATE
HOLED BARS**

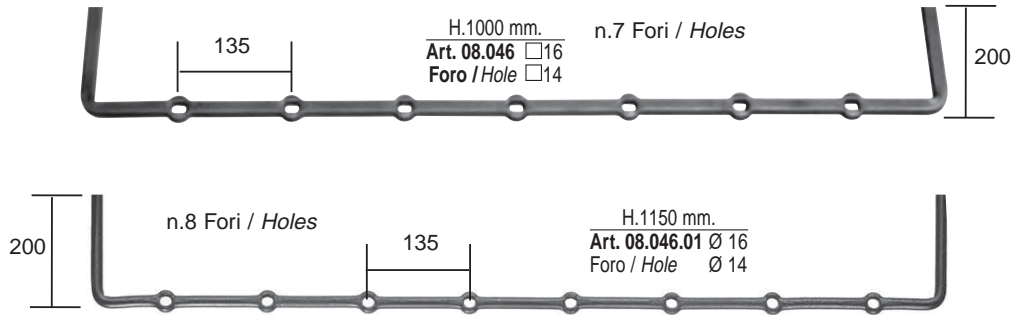

INT. standard: 125 mm. - n. Fori 15

MISURE STANDARD 2000 mm. / 2000 mm. STANDARD SIZE

INT. = INTERASSE / CENTRE DISTANCE

LUCE = DISTANCE BETWEEN HOLES

FORO = HOLE

<p>FORO QUADRO IN OBLIQUO SLANTING SQUARE HOLE</p> <p>INT. 125 15 Fori per barra Holes per bar</p> <p>H.2000 mm. Foro ◊ 12 Art. 08.047 ≡ 30 X 8 Art. 08.048 ≡ 30 X 10 Art. 08.049 ≡ 35 X 8 Art. 08.050 ≡ 35 X 10 Art. 08.051 ≡ 40 X 8 Art. 08.052 ≡ 40 X 10</p> <p>H.2000 mm. Foro ◊ 14 Art. 08.053 ≡ 30 X 8 Art. 08.054 ≡ 30 X 10 Art. 08.055 ≡ 35 X 8 Art. 08.056 ≡ 35 X 10 Art. 08.057 ≡ 40 X 8 Art. 08.058 ≡ 40 X 10</p> <p>H.2000 mm. Foro ◊ 16 Art. 08.058.01 ≡ 30 X 8 Art. 08.058.02 ≡ 30 X 10 Art. 08.058.03 ≡ 35 X 8 Art. 08.058.04 ≡ 35 X 10 Art. 08.058.05 ≡ 40 X 8 Art. 08.058.06 ≡ 40 X 10</p>	<p>FORO QUADRO IN OBLIQUO SLANTING SQUARE HOLE</p> <p>INT. 149</p> <p>INT. 149 mm. Luce 128 mm. n. Fori 12</p> <p>H.2000 mm. Foro ◊ 14 Art. 08.058.07 ≡ 30 X 8 Art. 08.058.08 ≡ 30 X 10</p>	<p>FORO QUADRO IN OBLIQUO SLANTING SQUARE HOLE</p> <p>INT. 74,5</p> <p>INT. 74,5 mm. Luce 53,5 mm. n. Fori 26</p> <p>H.2000 mm. Foro ◊ 14 Art. 08.058.09 ≡ 30 X 8 Art. 08.058.10 ≡ 30 X 10</p>	<p>FORO QUADRO SQUARE HOLE</p> <p>INT. 125 15 Fori per barra Holes per bar</p> <p>H.2000 mm. Foro □ 12 Art. 08.059 ≡ 30 X 8 Art. 08.060 ≡ 30 X 10 Art. 08.061 ≡ 35 X 8 Art. 08.062 ≡ 35 X 10 Art. 08.063 ≡ 40 X 8 Art. 08.064 ≡ 40 X 10</p> <p>H.2000 mm. Foro □ 14 Art. 08.065 ≡ 30 X 8 Art. 08.066 ≡ 30 X 10 Art. 08.067 ≡ 35 X 8 Art. 08.068 ≡ 35 X 10 Art. 08.069 ≡ 40 X 8 Art. 08.070 ≡ 40 X 10</p> <p>H.2000 mm. Foro □ 16 Art. 08.070.01 ≡ 30 X 8 Art. 08.070.02 ≡ 30 X 10 Art. 08.070.03 ≡ 35 X 8 Art. 08.070.04 ≡ 35 X 10 Art. 08.070.05 ≡ 40 X 8 Art. 08.070.06 ≡ 40 X 10</p>
--	--	---	--

<p>INT. 112</p> <p>INT. 112 17 Fori per barra 17 Holes per bar</p> <p>H. 2000 Foro / Hole ◊ 12 Art. 08.046.100 ≡ 30 X 8 mm</p> <p>H. 2000 Foro / Hole ◊ 14 Art. 08.046.106 ≡ 30 X 8 mm</p> <p>H. 2000 Foro / Hole ◊ 16 Art. 08.046.112 ≡ 30 X 8 mm</p>	<p>INT. 112</p> <p>INT. 112 17 Fori per barra 17 Holes per bar</p> <p>H. 2000 Foro / Hole □ 12 Art. 08.058.100 ≡ 30 X 8 mm</p> <p>H. 2000 Foro / Hole □ 14 Art. 08.058.106 ≡ 30 X 8 mm</p> <p>H. 2000 Foro / Hole □ 16 Art. 08.058.112 ≡ 30 X 8 mm</p>	<p>INT. 112</p> <p>INT. 112 17 Fori per barra 17 Holes per bar</p> <p>H. 2000 Foro / Hole Ø 12 Art. 08.070.100 ≡ 30 X 8 mm</p> <p>H. 2000 Foro / Hole Ø 14 Art. 08.070.106 ≡ 30 X 8 mm</p> <p>H. 2000 Foro / Hole Ø 16 Art. 08.070.112 ≡ 30 X 8 mm</p>
--	--	--

Le barre forate possono essere prodotte anche da 3000 mm. / Our flat punched bars are also available at 3 meter length.

Tutte le parti di questo catalogo - foto comprese - sono di proprietà Euro-Fer. La riproduzione, anche parziale, è vietata in ogni forma e con ogni mezzo. / Every part of this catalogue - photos included - is Euro-Fer's property. All forms of copying are strictly prohibited.

INT. standard: 125 mm. - n. Fori 15

MISURE STANDARD 2000 mm. / 2000 mm. STANDARD SIZE

INT. = INTERASSE / CENTRE DISTANCE

LUCE = DISTANCE BETWEEN HOLES

FORO = HOLE



FORO QUADRO
SQUARE HOLE



FORO QUADRO
SQUARE HOLE



FORO TONDO
ROUND HOLE

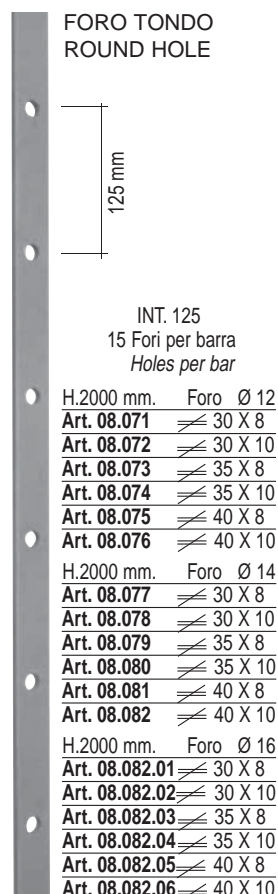

Piatto Martellato 4 Lati / *Hammered Flat - 4 Sides*

FORO QUADRO IN OBLIQUO
SLANTING SQUARE HOLE

INT. 125
15 Fori per barra / Holes per bar

H.2000 mm. Foro ◊ 12	Art. 08.082.20 ≡ 30 X 8
H.2000 mm. Foro ◊ 14	Art. 08.082.21 ≡ 30 X 10
H.2000 mm. Foro ◊ 16	Art. 08.082.22 ≡ 35 X 8
H.2000 mm. Foro ◊ 18	Art. 08.082.23 ≡ 35 X 10
H.2000 mm. Foro ◊ 20	Art. 08.082.24 ≡ 40 X 8
H.2000 mm. Foro ◊ 22	Art. 08.082.25 ≡ 40 X 10
H.2000 mm. Foro ◊ 14	Art. 08.082.26 ≡ 30 X 8
H.2000 mm. Foro ◊ 16	Art. 08.082.27 ≡ 30 X 10
H.2000 mm. Foro ◊ 18	Art. 08.082.28 ≡ 35 X 8
H.2000 mm. Foro ◊ 20	Art. 08.082.29 ≡ 35 X 10
H.2000 mm. Foro ◊ 22	Art. 08.082.30 ≡ 40 X 8
H.2000 mm. Foro ◊ 24	Art. 08.082.31 ≡ 40 X 10
H.2000 mm. Foro ◊ 16	Art. 08.082.32 ≡ 30 X 8
H.2000 mm. Foro ◊ 18	Art. 08.082.33 ≡ 30 X 10
H.2000 mm. Foro ◊ 20	Art. 08.082.34 ≡ 35 X 8
H.2000 mm. Foro ◊ 22	Art. 08.082.35 ≡ 35 X 10
H.2000 mm. Foro ◊ 24	Art. 08.082.36 ≡ 40 X 8
H.2000 mm. Foro ◊ 26	Art. 08.082.37 ≡ 40 X 10

FORO QUADRO
SQUARE HOLE

INT. 125
15 Fori per barra / Holes per bar

H.2000 mm. □ 12 X 12	Art. 08.082.38 ≡ 30 X 8
H.2000 mm. □ 14 X 14	Art. 08.082.39 ≡ 30 X 10
H.2000 mm. □ 16 X 16	Art. 08.082.40 ≡ 35 X 8
H.2000 mm. □ 18 X 18	Art. 08.082.41 ≡ 35 X 10
H.2000 mm. □ 20 X 20	Art. 08.082.42 ≡ 40 X 8
H.2000 mm. □ 22 X 22	Art. 08.082.43 ≡ 40 X 10
H.2000 mm. □ 14 X 14	Art. 08.082.44 ≡ 30 X 8
H.2000 mm. □ 16 X 16	Art. 08.082.45 ≡ 30 X 10
H.2000 mm. □ 18 X 18	Art. 08.082.46 ≡ 35 X 8
H.2000 mm. □ 20 X 20	Art. 08.082.47 ≡ 35 X 10
H.2000 mm. □ 22 X 22	Art. 08.082.48 ≡ 40 X 8
H.2000 mm. □ 24 X 24	Art. 08.082.49 ≡ 40 X 10
H.2000 mm. □ 16 X 16	Art. 08.082.50 ≡ 30 X 8
H.2000 mm. □ 18 X 18	Art. 08.082.51 ≡ 30 X 10
H.2000 mm. □ 20 X 20	Art. 08.082.52 ≡ 35 X 8
H.2000 mm. □ 22 X 22	Art. 08.082.53 ≡ 35 X 10
H.2000 mm. □ 24 X 24	Art. 08.082.54 ≡ 40 X 8
H.2000 mm. □ 26 X 26	Art. 08.082.55 ≡ 40 X 10

FORO TONDO
ROUND HOLE

INT. 125
15 Fori per barra / Holes per bar

H.2000 mm. Ø 12	Art. 08.082.56 ≡ 30 X 8
H.2000 mm. Ø 14	Art. 08.082.57 ≡ 30 X 10
H.2000 mm. Ø 16	Art. 08.082.58 ≡ 35 X 8
H.2000 mm. Ø 18	Art. 08.082.59 ≡ 35 X 10
H.2000 mm. Ø 20	Art. 08.082.60 ≡ 40 X 8
H.2000 mm. Ø 22	Art. 08.082.61 ≡ 40 X 10
H.2000 mm. Ø 14	Art. 08.082.62 ≡ 30 X 8
H.2000 mm. Ø 16	Art. 08.082.63 ≡ 30 X 10
H.2000 mm. Ø 18	Art. 08.082.64 ≡ 35 X 8
H.2000 mm. Ø 20	Art. 08.082.65 ≡ 35 X 10
H.2000 mm. Ø 22	Art. 08.082.66 ≡ 40 X 8
H.2000 mm. Ø 24	Art. 08.082.67 ≡ 40 X 10
H.2000 mm. Ø 16	Art. 08.082.68 ≡ 30 X 8
H.2000 mm. Ø 18	Art. 08.082.69 ≡ 30 X 10
H.2000 mm. Ø 20	Art. 08.082.70 ≡ 35 X 8
H.2000 mm. Ø 22	Art. 08.082.71 ≡ 35 X 10
H.2000 mm. Ø 24	Art. 08.082.72 ≡ 40 X 8
H.2000 mm. Ø 26	Art. 08.082.73 ≡ 40 X 10

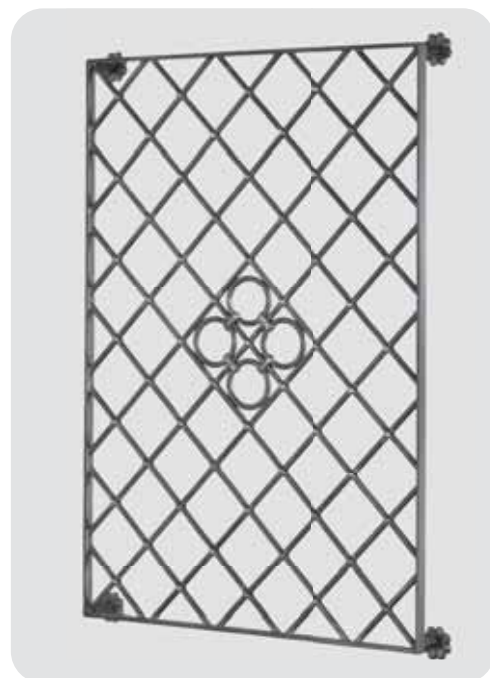

Le barre forate possono essere prodotte anche da 3000 mm. / Our flat punched bars are also available at 3 meter length.

Tutte le parti di questo catalogo - foto comprese - sono di proprietà Euro-Fer. La riproduzione, anche parziale, è vietata in ogni forma e con ogni mezzo. / Every part of this catalogue - photos included - is Euro-Fer's property. All forms of copying are strictly prohibited.

BARRE FORATE HOLED BARS

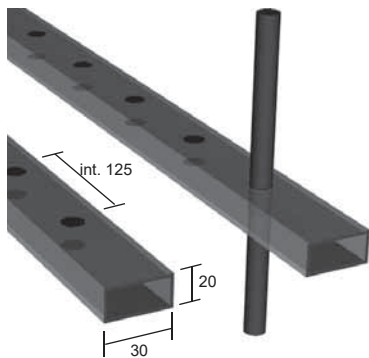

30 x 20 x 2 mm

Tubo liscio / Plain

int. 125 mm - fori passanti / int. 125 mm - fully drilled holes

	H. 2000	
Art. 08.082.100	foro Ø 12	nr. 15 fori
Art. 08.082.101	foro Ø 14	nr. 15 fori
Art. 08.082.102	foro □ 12	nr. 15 fori

	H. 3000	
Art. 08.082.105	foro Ø 12	nr. 23 fori
Art. 08.082.106	foro Ø 14	nr. 23 fori
Art. 08.082.107	foro □ 12	nr. 23 fori

Fuori Produzione / Out of Production
H. 6000

Art. 08.082.110	foro Ø 12	nr. 47 fori
Art. 08.082.111	foro Ø 14	nr. 47 fori
Art. 08.082.112	foro □ 12	nr. 47 fori

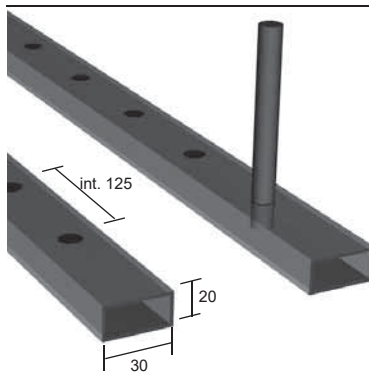

30 x 20 x 2 mm

Tubo liscio / Plain

int. 125 mm - fori in battuta / int. 125 mm - part drilled holes

	H. 2000	
Art. 08.082.115	foro Ø 12	nr. 15 fori
Art. 08.082.116	foro □ 12	nr. 15 fori

	H. 3000	
Art. 08.082.118	foro Ø 12	nr. 23 fori
Art. 08.082.119	foro □ 12	nr. 23 fori

Fuori Produzione / Out of Production
H. 6000

Art. 08.082.121	foro Ø 12	nr. 47 fori
Art. 08.082.122	foro □ 12	nr. 47 fori

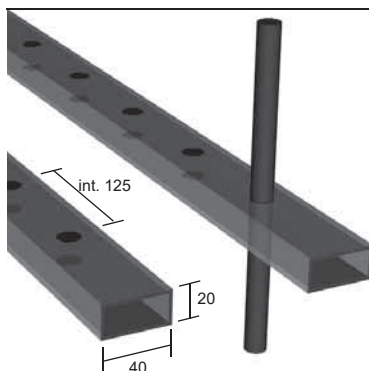

40 x 20 x 2 mm

Tubo liscio / Plain

int. 125 mm - fori passanti / int. 125 mm - fully drilled holes

	H. 2000	
Art. 08.082.148	foro Ø 12	nr. 15 fori
Art. 08.082.149	foro Ø 14	nr. 15 fori
Art. 08.082.154	foro □ 12	nr. 15 fori
Art. 08.082.155	foro □ 14	nr. 15 fori

	H. 3000	
Art. 08.082.163	foro Ø 12	nr. 23 fori
Art. 08.082.164	foro Ø 14	nr. 23 fori
Art. 08.082.169	foro □ 12	nr. 23 fori
Art. 08.082.170	foro □ 14	nr. 23 fori

Fuori Produzione / Out of Production
H. 6000

Art. 08.082.178	foro Ø 12	nr. 47 fori
Art. 08.082.179	foro Ø 14	nr. 47 fori
Art. 08.082.184	foro □ 12	nr. 47 fori
Art. 08.082.185	foro □ 14	nr. 47 fori

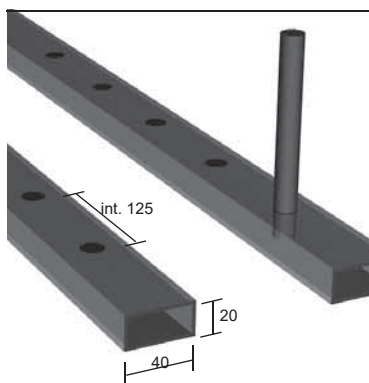

40 x 20 x 2 mm - Tubo liscio / Plain

int. 125 mm - fori in battuta / int. 125 mm - part drilled holes

	H. 2000	
Art. 08.082.194	foro Ø 14	nr. 15 fori
Art. 08.082.200	foro □ 14	nr. 15 fori

	H. 3000	
Art. 08.082.208	foro Ø 14	nr. 23 fori
Art. 08.082.214	foro □ 14	nr. 23 fori

Fuori Produzione / Out of Production
H. 6000

Art. 08.082.222	foro Ø 14	nr. 47 fori
Art. 08.082.228	foro □ 14	nr. 47 fori

a richiesta foro Ø 12 mm e □ 12 mm / on request hole Ø 12 mm and □ 12 mm

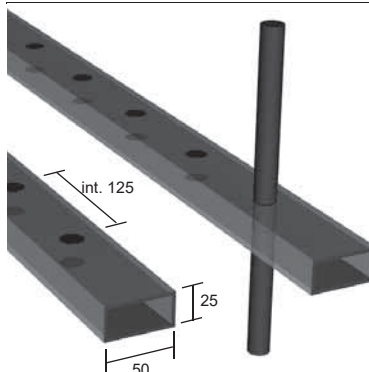

50 x 25 x 2 mm - Tubo liscio / Plain

int. 125 mm - fori passanti / int. 125 mm - fully drilled holes

	H. 2000	
Art. 08.082.323	foro Ø 14	nr. 15 fori
Art. 08.082.330	foro □ 14	nr. 15 fori

	H. 3000	
Art. 08.082.340	foro Ø 14	nr. 23 fori
Art. 08.082.347	foro □ 14	nr. 23 fori

Fuori Produzione / Out of Production
H. 6000

Art. 08.082.357	foro Ø 14	nr. 47 fori
Art. 08.082.364	foro □ 14	nr. 47 fori

a richiesta foro Ø 12 mm e □ 12 mm / on request hole Ø 12 mm and □ 12 mm

50 x 25 x 2 mm - Tubo liscio / Plain int. 125 mm - fori in battuta / int. 125 mm - part drilled holes

H. 2000			H. 3000		
Art. 08.082.374	foro Ø 14	nr. 15 fori	Art. 08.082.390	foro Ø 14	nr. 23 fori
Art. 08.082.381	foro □ 14	nr. 15 fori	Art. 08.082.397	foro □ 14	nr. 23 fori

Fuori Produzione / Out of Production		
H. 6000		
Art. 08.082.406	foro Ø 14	nr. 47 fori
Art. 08.082.413	foro □ 14	nr. 47 fori

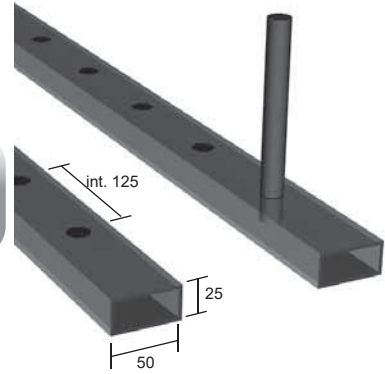

a richiesta foro Ø 12 mm e □ 12 mm / on request hole Ø 12 mm and □ 12 mm

40 x 40 x 3 mm - Tubo liscio / Plain int. 125 mm - fori passanti / int. 125 mm - fully drilled holes

H. 2000			H. 3000		
Art. 08.082.510	foro Ø 12	nr. 15 fori	Art. 08.082.520	foro Ø 12	nr. 23 fori
Art. 08.082.511	foro Ø 14	nr. 15 fori	Art. 08.082.521	foro Ø 14	nr. 23 fori
Art. 08.082.512	foro □ 12	nr. 15 fori	Art. 08.082.522	foro □ 12	nr. 23 fori
Art. 08.082.513	foro □ 14	nr. 15 fori	Art. 08.082.523	foro □ 14	nr. 23 fori

Fuori Produzione / Out of Production		
H. 6000		
Art. 08.082.530	foro Ø 12	nr. 47 fori
Art. 08.082.531	foro Ø 14	nr. 47 fori
Art. 08.082.532	foro □ 12	nr. 47 fori
Art. 08.082.533	foro □ 14	nr. 47 fori

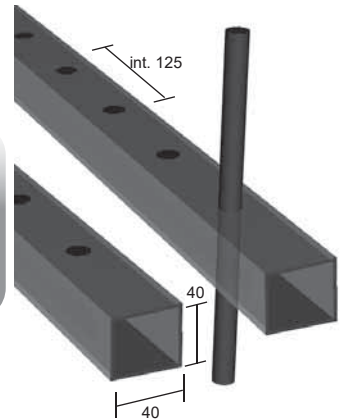

Su richiesta è possibile realizzare tubi forati di diverse lunghezze e con diverse misure di interasse
Customized sizes and dimensions available on demand

Per realizzare un tubo forato a misura dovete indicare /
For customized items please indicate:

Tipo di tubo / Type of tube

- 30x20 x 2mm Tubo Liscio / Plain
- 40x20 x 2mm Tubo Liscio / Plain
- 40x40 x 3mm Tubo Liscio / Plain
- 50x25 x 2mm Tubo Liscio / Plain

fori passanti / fully drilled holes

fori in battuta / part drilled holes

Numero dei fori / Number of holes

Tipo di fori e dimensioni / Kind and sizes of hole

□ mm

Ø mm

Lunghezza tubo / Tube lenght

Int. A / Int. A

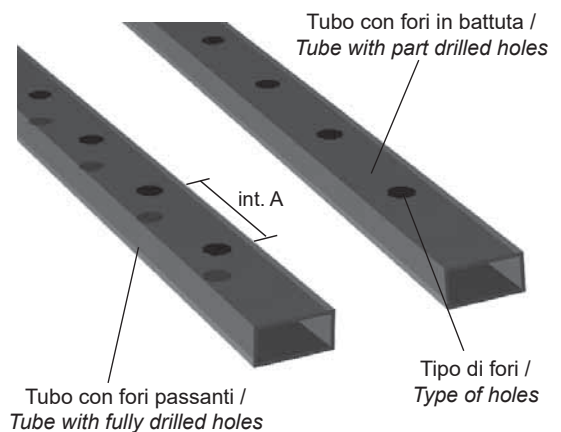

Cliente

Data

Timbro e Firma

Note



H.6000 mm. □ 12 X 12
Art. 08.083 INT. 120
Art. 08.084 INT. 140
Art. 08.085 INT. 160
Art. 08.086 INT. 180
Art. 08.087 INT. 200
Art. 08.088 INT. 300
H.6000 mm. □ 14 X 14
Art. 08.089 INT. 120
Art. 08.090 INT. 140
Art. 08.091 INT. 160
Art. 08.092 INT. 180
Art. 08.093 INT. 200
Art. 08.094 INT. 300



H.2000 mm. ≇ 20x4
Art. 08.094.50 INT. 120
Art. 08.094.51 INT. 160

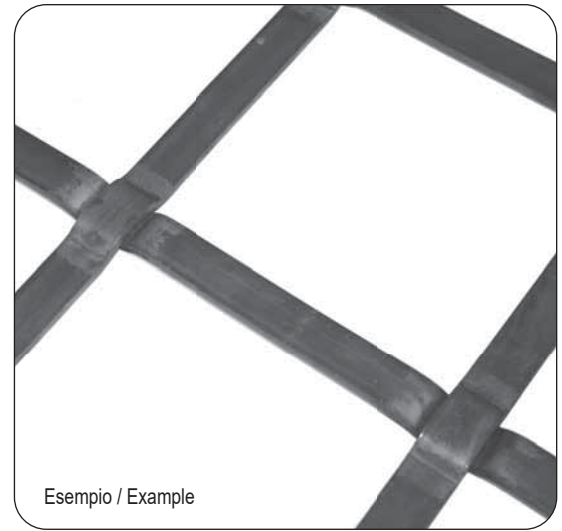

Esempio / Example

SALISBURGHESI

LE BARRE "SALISBURGHESI" SONO FORNITE SINGOLARMENTE: SONO ACCOPPIATE SOLO A TITOLO DIMOSTRATIVO.
THE "SALISBURGHESI" BARS ARE SUPPLIED SEPARATELY: THEY ARE ONLY IN PAIRS FOR DEMONSTRATION PURPOSES.

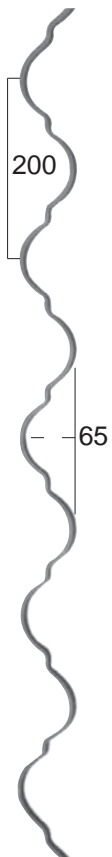

H.2500 X L.65 mm.
Art. 08.095
≇ 16 X 5

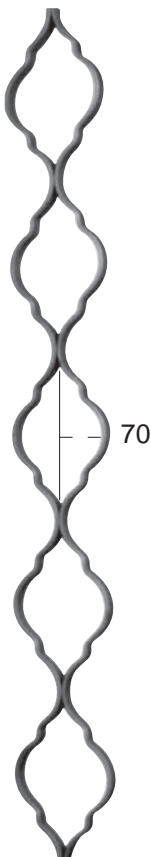

H.2500 X L.70 mm.
Art. 08.096 ≇ 16 X 8
Rigato / Striped

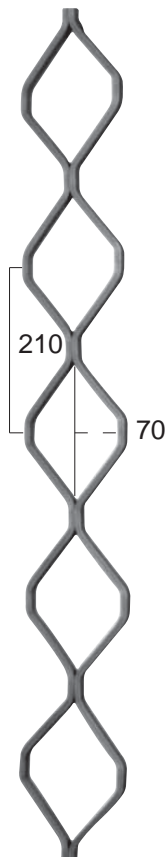

H.2500 X L.70 mm.
Art. 08.097 ≇ 16 X 8
Rigato / Striped



H.2500 X L.65 mm.
Art. 08.098 ≇ 16 X 8
Art. 08.099 Ø 10
Art. 08.100 Ø 12

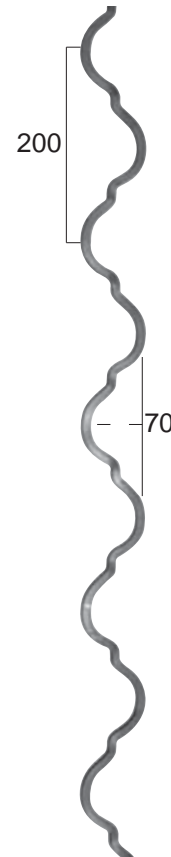

H.2500 X L.70 mm.
Art. 08.101 □ 8
Art. 08.102 □ 10
Art. 08.103 □ 12

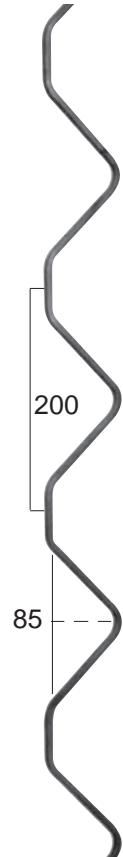

H.2500 X L.85 mm.
Art. 08.104
□ 8 X 8



Spazio per inserimento □ 14 mm.
Space for square insert □ 14 mm.

FORO
OBLIQUO
SLANTING
HOLE

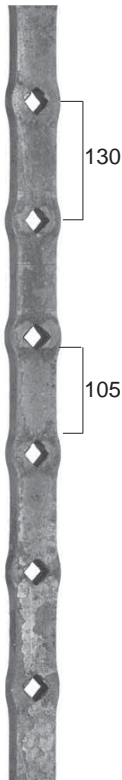

Martellato / *Hammered*
H.2000 mm. □ 14 X 14
Art. 08.105 INT.125 mm.
N. Nocchie / *Knobs* 16

Liscio / *Smooth*
H.2000 mm. □ 14 X 14
Art. 08.105.01 INT.125 mm.
N. Nocchie / *Knobs* 16

H.2000 mm. ≙ 50 X 20
Art. 08.105.02 INT.130 mm.
Luce 105 mm.
N. Fori / *Holes* 14 ◇ 22

PIATTI CON RIBATTINI STAMPATI
PLAT BARS WITH FORGED RIVETS



PIATTO LISCIO
SMOOTH FLAT

H.2000 mm.
Art. 08.182
≙ 30 X 6
INT. 125 mm.



PIATTO MARTELLATO
HAMMERED
FLAT

H.2000 mm.
Art. 08.183
≙ 30 X 6
INT. 125 mm.



PIATTO SAGOMATO
MODELLED
FLAT

H.2000 mm.
Art. 08.184
≙ 30 X 8
INT. 132 mm.

H.3000 mm.
Art. 08.184.01
≙ 30 X 8
INT. 132 mm.



Liscio / *Smooth*
Foro ad asola / *Buttonhole*
H.2000 mm ≙ 40 x 8 mm

Art. 08.199 fori / hole □ 12 mm - int. 130 mm - n°14 fori / holes
Art. 08.199.01 fori / hole □ 12 mm - int. 135 mm - n°14 fori / holes
Art. 08.199.02 fori / hole □ 14 mm - int. 130 mm - n°14 fori / holes
Art. 08.199.03 fori / hole □ 14 mm - int. 135 mm - n°14 fori / holes
Art. 08.200 fori / hole □ 16 mm - int. 130 mm - n°14 fori / holes
Art. 08.200.01 fori / hole □ 16 mm - int. 135 mm - n°14 fori / holes

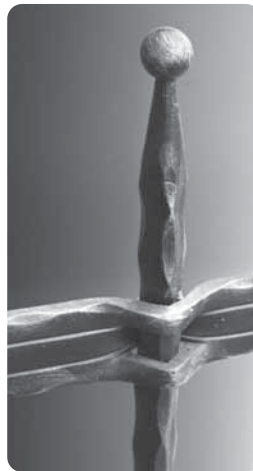

Martellato / *Hammered*
Foro ad asola / *Buttonhole*
H.2000 mm ≙ 40 x 8 mm

Art. 08.200.10 fori / hole □ 12 mm - int. 130 mm - n°14 fori / holes
Art. 08.200.11 fori / hole □ 12 mm - int. 135 mm - n°14 fori / holes
Art. 08.200.12 fori / hole □ 14 mm - int. 130 mm - n°14 fori / holes
Art. 08.200.13 fori / hole □ 14 mm - int. 135 mm - n°14 fori / holes
Art. 08.201 fori / hole □ 16 mm - int. 130 mm - n°14 fori / holes
Art. 08.201.01 fori / hole □ 16 mm - int. 135 mm - n°14 fori / holes

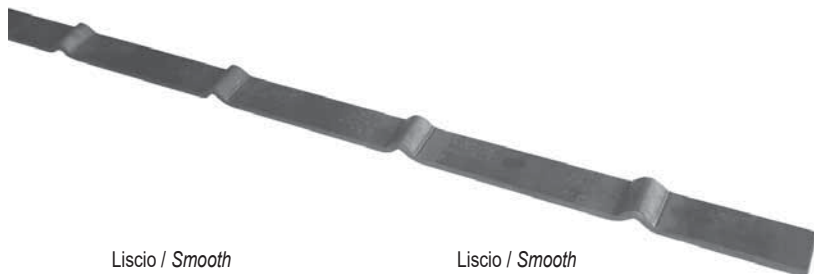

Liscio / *Smooth*
H.2000 mm ≙ 30 x 5 mm
Art. 08.210 □ 14 mm - int. 130 mm
Art. 08.211 □ 14 mm - int. 145 mm

Liscio / *Smooth*
H.2000 mm ≙ 30 x 5 mm
Art. 08.214 □ 16 mm - int. 130 mm
Art. 08.215 □ 16 mm - int. 145 mm

Liscio / *Smooth*
H.3000 mm ≙ 30 x 5 mm
Art. 08.212 □ 14 mm - int. 130 mm
Art. 08.213 □ 14 mm - int. 145 mm

Liscio / *Smooth*
H.3000 mm ≙ 30 x 5 mm
Art. 08.216 □ 16 mm - int. 130 mm
Art. 08.217 □ 16 mm - int. 145 mm

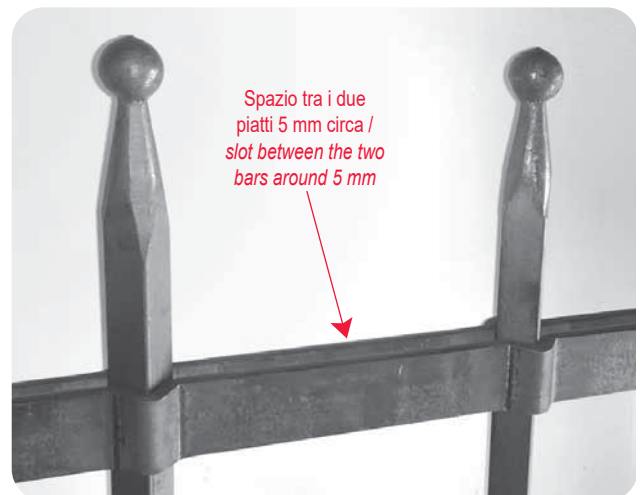

Spazio tra i due
piatti 5 mm circa /
slot between the two
bars around 5 mm

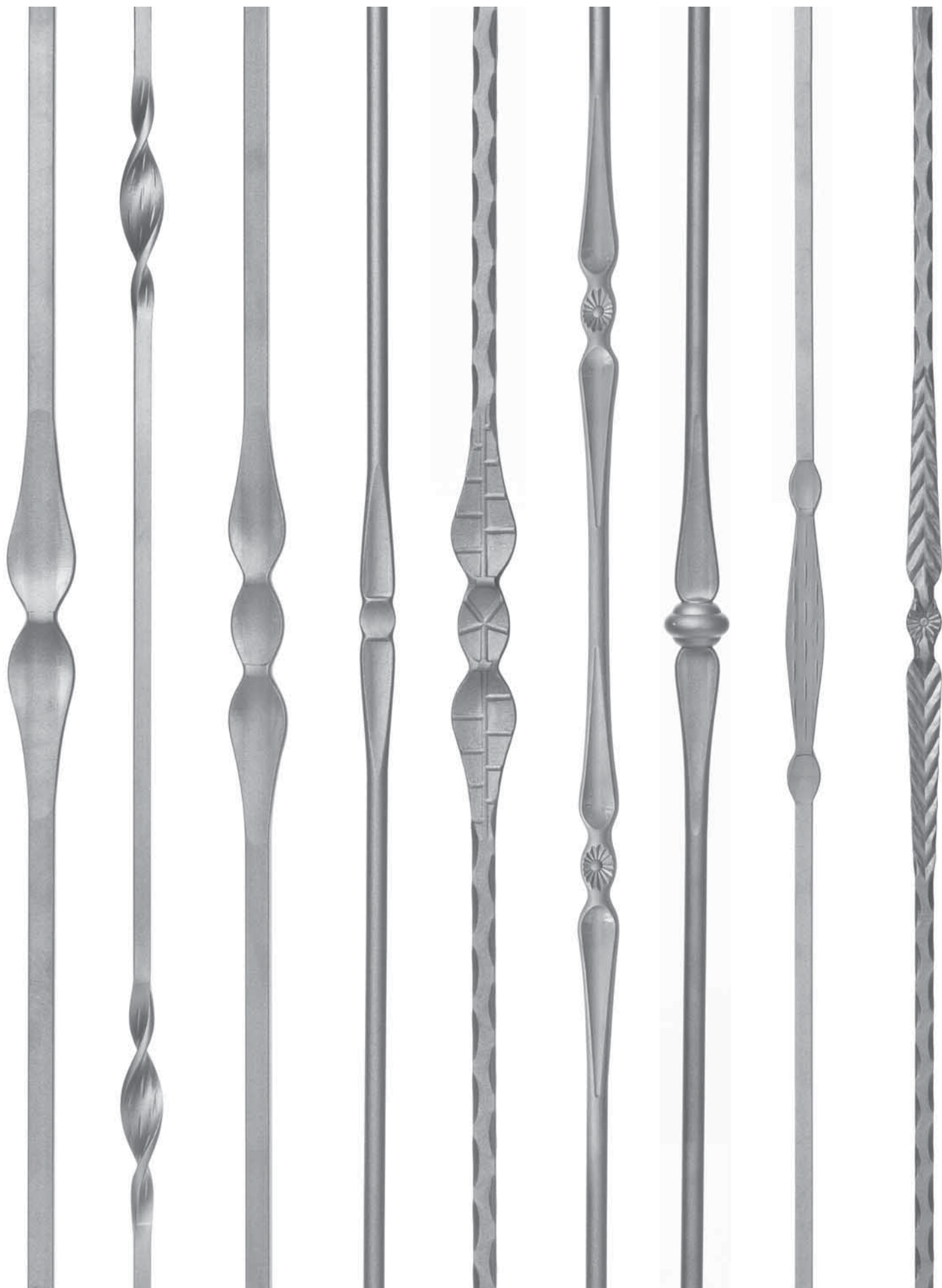

Tutte le parti di questo catalogo - foto comprese - sono di proprietà Euro-Fer. La riproduzione, anche parziale, è vietata in ogni forma e con ogni mezzo. / Every part of this catalogue - photos included - is Euro-Fer's property. All forms of copying are strictly prohibited.

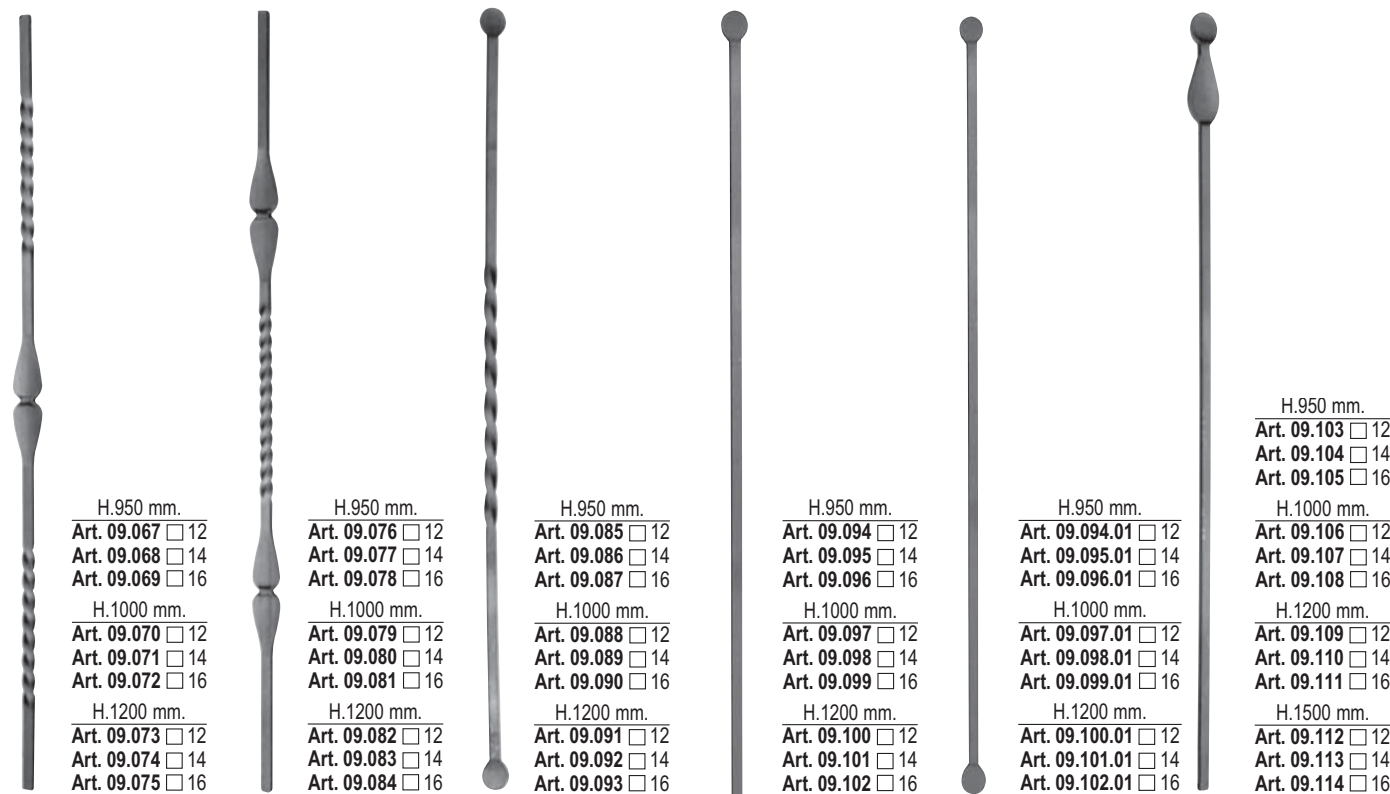
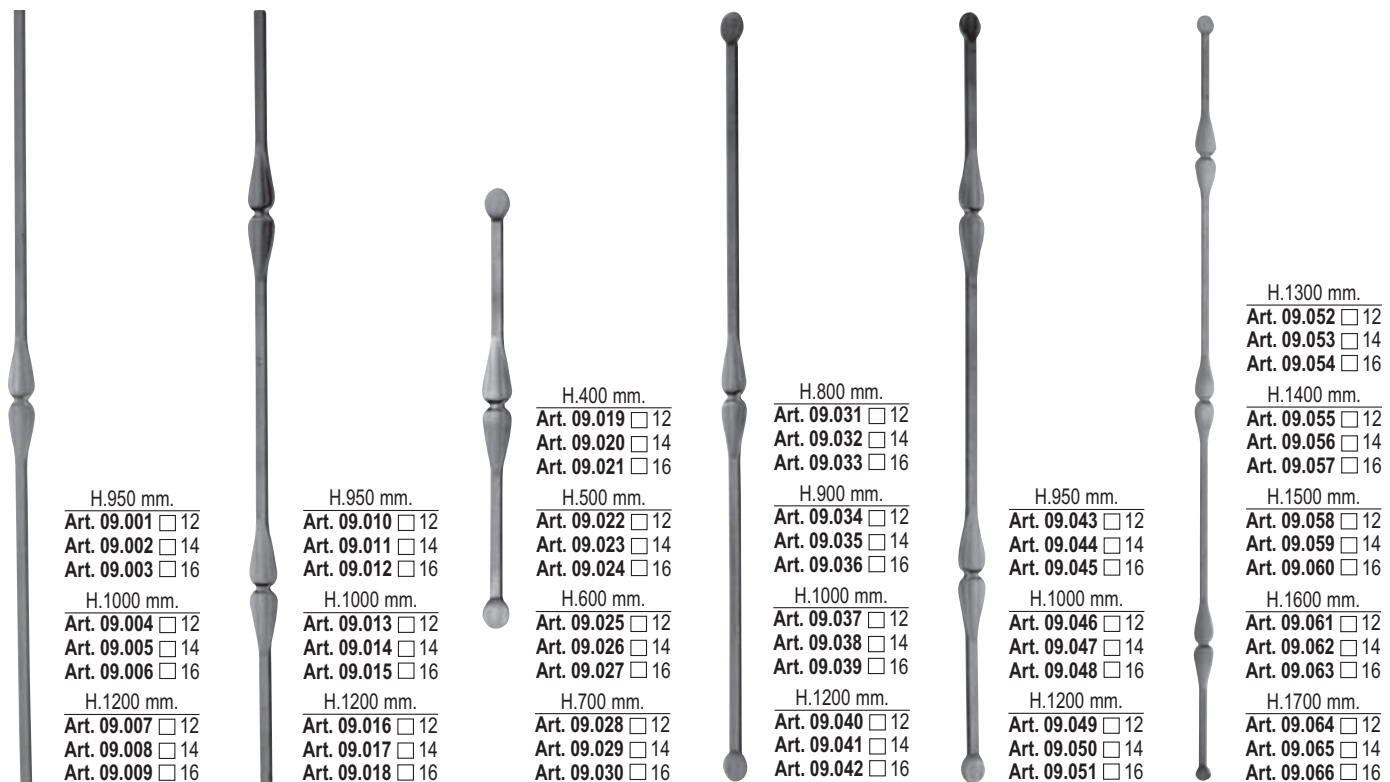

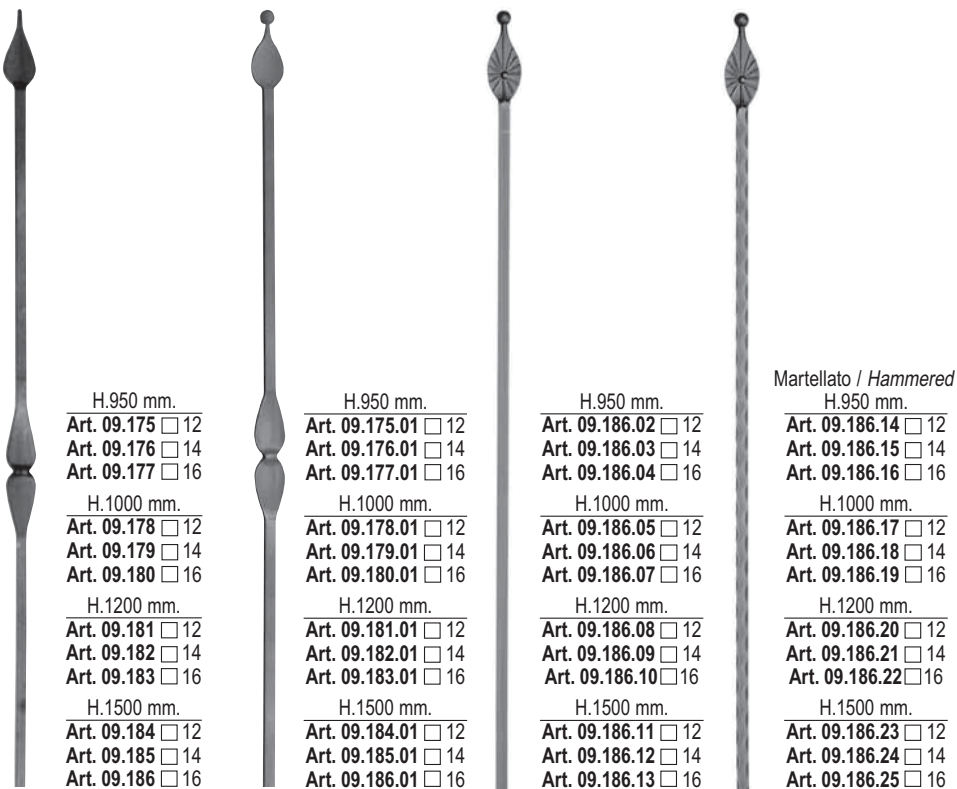
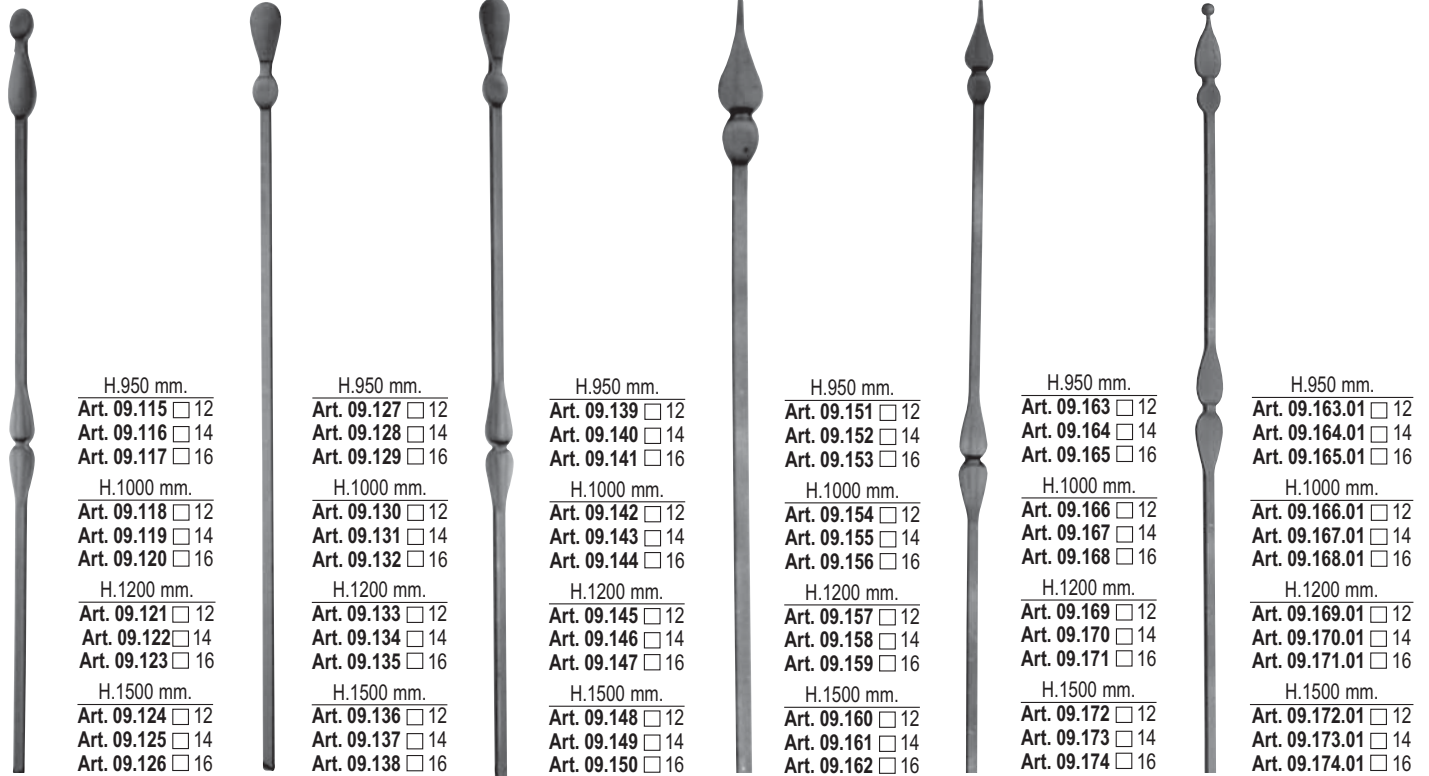

A RICHIESTA CON PALLINA SULLA LANCIA
ON REQUEST WITH BALL ON THE SPEAR

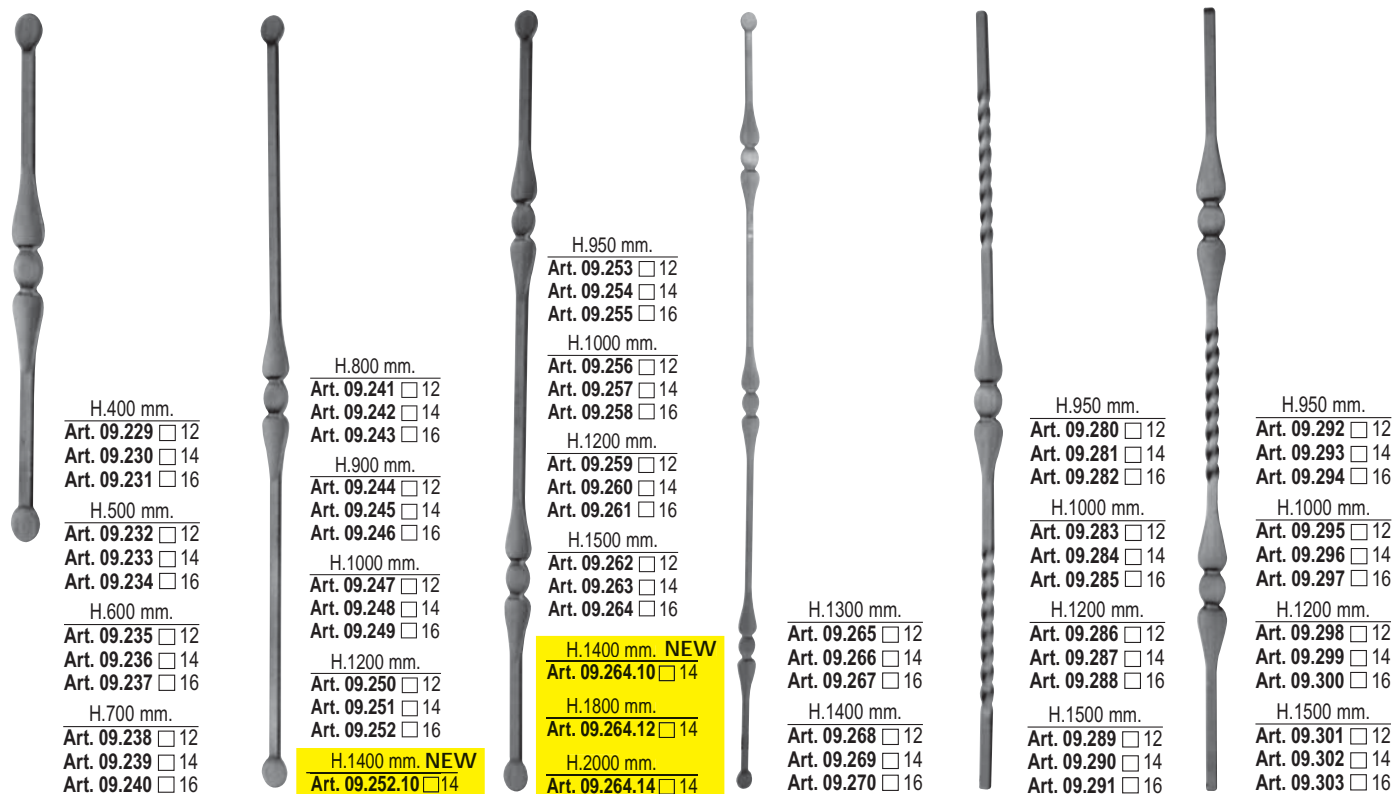
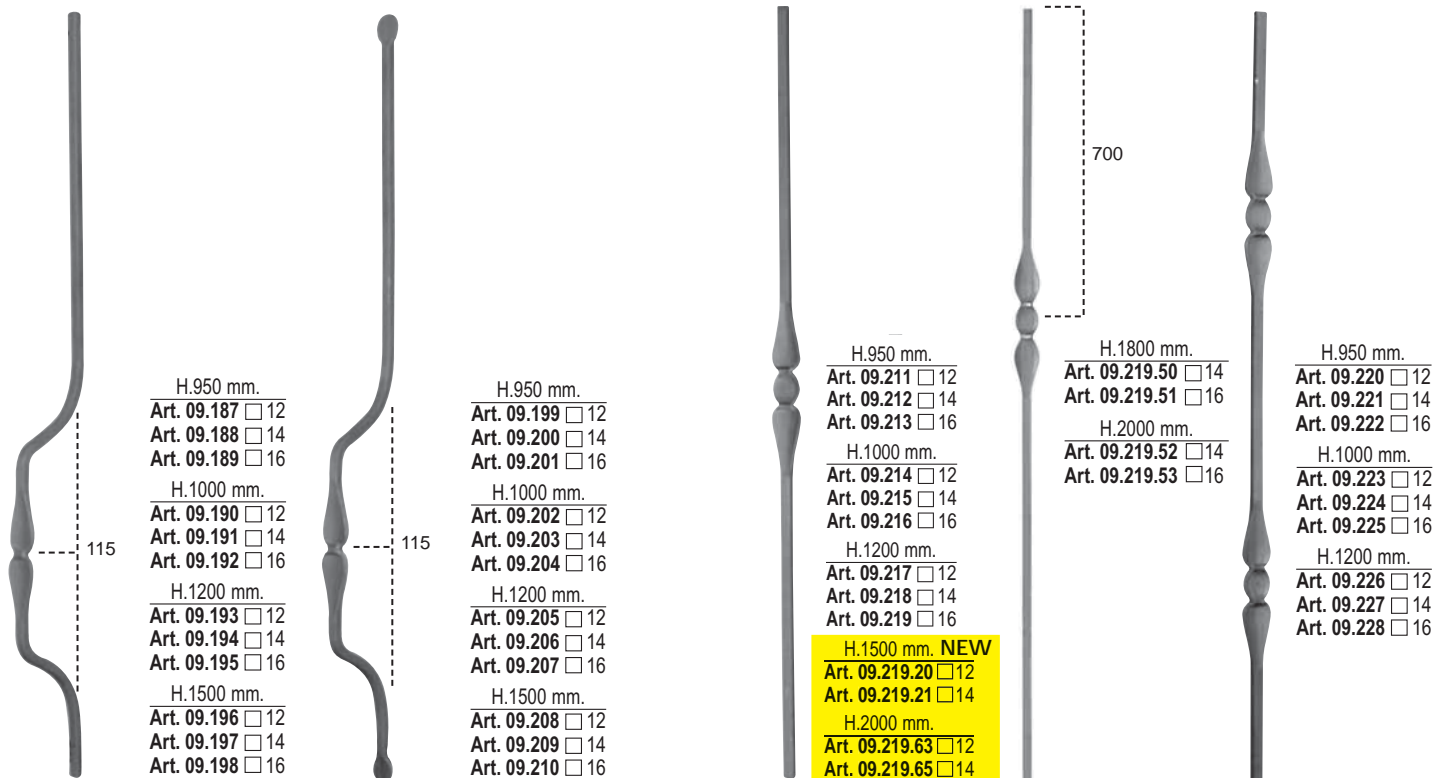

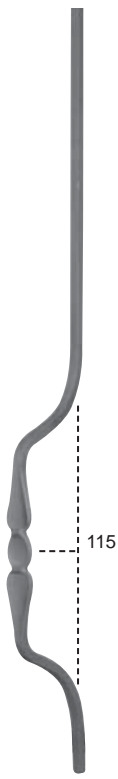

- H.950 mm.
- Art. 09.304 12
- Art. 09.305 14
- Art. 09.306 16
- H.1000 mm.
- Art. 09.307 12
- Art. 09.308 14
- Art. 09.309 16
- H.1200 mm.
- Art. 09.310 12
- Art. 09.311 14
- Art. 09.312 16
- H.1500 mm.
- Art. 09.313 12
- Art. 09.314 14
- Art. 09.315 16
- H.1800 mm.
- Art. 09.316 12
- Art. 09.317 14
- Art. 09.318 16



- H.950 mm.
- Art. 09.319 12
- Art. 09.320 14
- Art. 09.321 16
- H.1000 mm.
- Art. 09.322 12
- Art. 09.323 14
- Art. 09.324 16
- H.1200 mm.
- Art. 09.325 12
- Art. 09.326 14
- Art. 09.327 16
- H.1500 mm.
- Art. 09.328 12
- Art. 09.329 14
- Art. 09.330 16
- H.1800 mm.
- Art. 09.331 12
- Art. 09.332 14
- Art. 09.333 16



- H.950 mm.
- Art. 09.334 12
- Art. 09.335 14
- Art. 09.336 16
- H.1000 mm.
- Art. 09.337 12
- Art. 09.338 14
- Art. 09.339 16
- H.1200 mm.
- Art. 09.340 12
- Art. 09.341 14
- Art. 09.342 16
- H.1500 mm.
- Art. 09.343 12
- Art. 09.344 14
- Art. 09.345 16
- H.1800 mm.
- Art. 09.346 12
- Art. 09.347 14
- Art. 09.348 16



- H.900 mm. **NEW**
- Art. 09.348.50 12
- Art. 09.348.51 14
- H.950 mm.
- Art. 09.349 12
- Art. 09.350 14
- Art. 09.351 16
- H.1000 mm.
- Art. 09.352 12
- Art. 09.353 14
- Art. 09.354 16
- H.1200 mm.
- Art. 09.355 12
- Art. 09.356 14
- Art. 09.357 16
- H.1400 mm. **NEW**
- Art. 09.363.20 14
- H.1500 mm.
- Art. 09.358 12
- Art. 09.359 14
- Art. 09.360 16
- H.1800 mm.
- Art. 09.361 12
- Art. 09.362 14
- Art. 09.363 16
- H.1600 mm. **NEW**
- Art. 09.363.23 14
- H.1700 mm.
- Art. 09.363.26 14
- H.1800 mm.
- Art. 09.363.29 14



- H.950 mm.
- Art. 09.364 12
- Art. 09.365 14
- Art. 09.366 16
- H.1000 mm.
- Art. 09.367 12
- Art. 09.368 14
- Art. 09.369 16
- H.1200 mm.
- Art. 09.370 12
- Art. 09.371 14
- Art. 09.372 16
- H.1500 mm.
- Art. 09.373 12
- Art. 09.374 14
- Art. 09.375 16
- H.1800 mm.
- Art. 09.376 12
- Art. 09.377 14



- H.950 mm.
- Art. 09.379 12
- Art. 09.380 14
- Art. 09.381 16
- H.1000 mm.
- Art. 09.382 12
- Art. 09.383 14
- Art. 09.384 16
- H.1200 mm.
- Art. 09.385 12
- Art. 09.386 14
- Art. 09.387 16
- H.1500 mm.
- Art. 09.388 12
- Art. 09.389 14
- Art. 09.390 16
- H.1800 mm.
- Art. 09.391 12
- Art. 09.392 14
- Art. 09.393 16



- H.950 mm.
- Art. 09.394 12
- Art. 09.395 14
- Art. 09.396 16
- H.1000 mm.
- Art. 09.397 12
- Art. 09.398 14
- Art. 09.399 16
- H.1200 mm.
- Art. 09.400 12
- Art. 09.401 14
- Art. 09.402 16
- H.1500 mm.
- Art. 09.403 12
- Art. 09.404 14
- Art. 09.405 16



- H.950 mm.
- Art. 09.406 12
- Art. 09.407 14
- Art. 09.408 16
- H.1000 mm.
- Art. 09.409 12
- Art. 09.410 14
- Art. 09.411 16
- H.1200 mm.
- Art. 09.412 12
- Art. 09.413 14
- Art. 09.414 16
- H.1500 mm.
- Art. 09.415 12
- Art. 09.416 14
- Art. 09.417 16



- H.950 mm.
- Art. 09.418 12
- Art. 09.419 14
- Art. 09.420 16
- H.1000 mm.
- Art. 09.421 12
- Art. 09.422 14
- Art. 09.423 16
- H.1200 mm.
- Art. 09.424 12
- Art. 09.425 14
- Art. 09.426 16
- H.1500 mm.
- Art. 09.427 12
- Art. 09.428 14
- Art. 09.429 16



A RICHIESTA CON PALLINA SULLA LANCIA
ON REQUEST WITH BALL ON THE SPEAR



H.950 mm.
Art. 09.430 □ 12
Art. 09.431 □ 14
Art. 09.432 □ 16

H.1000 mm.
Art. 09.433 □ 12
Art. 09.434 □ 14
Art. 09.435 □ 16

H.1200 mm.
Art. 09.436 □ 12
Art. 09.437 □ 14
Art. 09.438 □ 16

H.1500 mm.
Art. 09.439 □ 12
Art. 09.440 □ 14
Art. 09.441 □ 16



H.950 mm.
Art. 09.442 □ 12
Art. 09.443 □ 14
Art. 09.444 □ 16

H.1000 mm.
Art. 09.445 □ 12
Art. 09.446 □ 14
Art. 09.447 □ 16

H.1200 mm.
Art. 09.448 □ 12
Art. 09.449 □ 14
Art. 09.450 □ 16

H.1500 mm.
Art. 09.451 □ 12
Art. 09.452 □ 14
Art. 09.453 □ 16



H.950 mm.
Art. 09.442.01 □ 12
Art. 09.443.01 □ 14
Art. 09.444.01 □ 16

H.1000 mm.
Art. 09.445.01 □ 12
Art. 09.446.01 □ 14
Art. 09.447.01 □ 16

H.1200 mm.
Art. 09.448.01 □ 12
Art. 09.449.01 □ 14
Art. 09.450.01 □ 16

H.1500 mm.
Art. 09.451.01 □ 12
Art. 09.452.01 □ 14
Art. 09.453.01 □ 16



H.950 mm.
Art. 09.454 □ 12
Art. 09.455 □ 14
Art. 09.456 □ 16

H.1000 mm.
Art. 09.457 □ 12
Art. 09.458 □ 14
Art. 09.459 □ 16

H.1200 mm.
Art. 09.460 □ 12
Art. 09.461 □ 14
Art. 09.462 □ 16

H.1500 mm.
Art. 09.463 □ 12
Art. 09.464 □ 14
Art. 09.465 □ 16



H.950 mm.
Art. 09.454.01 □ 12
Art. 09.455.01 □ 14
Art. 09.456.01 □ 16

H.1000 mm.
Art. 09.457.01 □ 12
Art. 09.458.01 □ 14
Art. 09.459.01 □ 16

H.1200 mm.
Art. 09.460.01 □ 12
Art. 09.461.01 □ 14
Art. 09.462.01 □ 16

H.1500 mm.
Art. 09.463.01 □ 12
Art. 09.464.01 □ 14
Art. 09.465.01 □ 16



H.950 X L.175 mm.
Art. 09.466
□ 12 ≧ 12 X 6



H.950 X L.175 mm.
Art. 09.467
□ 12 ≧ 12 X 6



H.950 X L.150 mm.
Art. 09.468
□ 12 ≧ 12 X 6



Martel. / *Hammered*
H.950 mm.
Art. 09.468.01 □ 12
Art. 09.468.02 □ 14
Art. 09.468.03 □ 16

H.1000 mm.
Art. 09.468.04 □ 12
Art. 09.468.05 □ 14
Art. 09.468.06 □ 16

H.1200 mm.
Art. 09.468.07 □ 12
Art. 09.468.08 □ 14
Art. 09.468.09 □ 16

H.1500 mm.
Art. 09.468.10 □ 12
Art. 09.468.11 □ 14
Art. 09.468.12 □ 16



Martel. / *Hammered*
H.950 mm.
Art. 09.468.13 □ 12
Art. 09.468.14 □ 14
Art. 09.468.15 □ 16

H.1000 mm.
Art. 09.468.16 □ 12
Art. 09.468.17 □ 14
Art. 09.468.18 □ 16

H.1200 mm.
Art. 09.468.19 □ 12
Art. 09.468.20 □ 14
Art. 09.468.21 □ 16

H.1500 mm.
Art. 09.468.22 □ 12
Art. 09.468.23 □ 14
Art. 09.468.24 □ 16

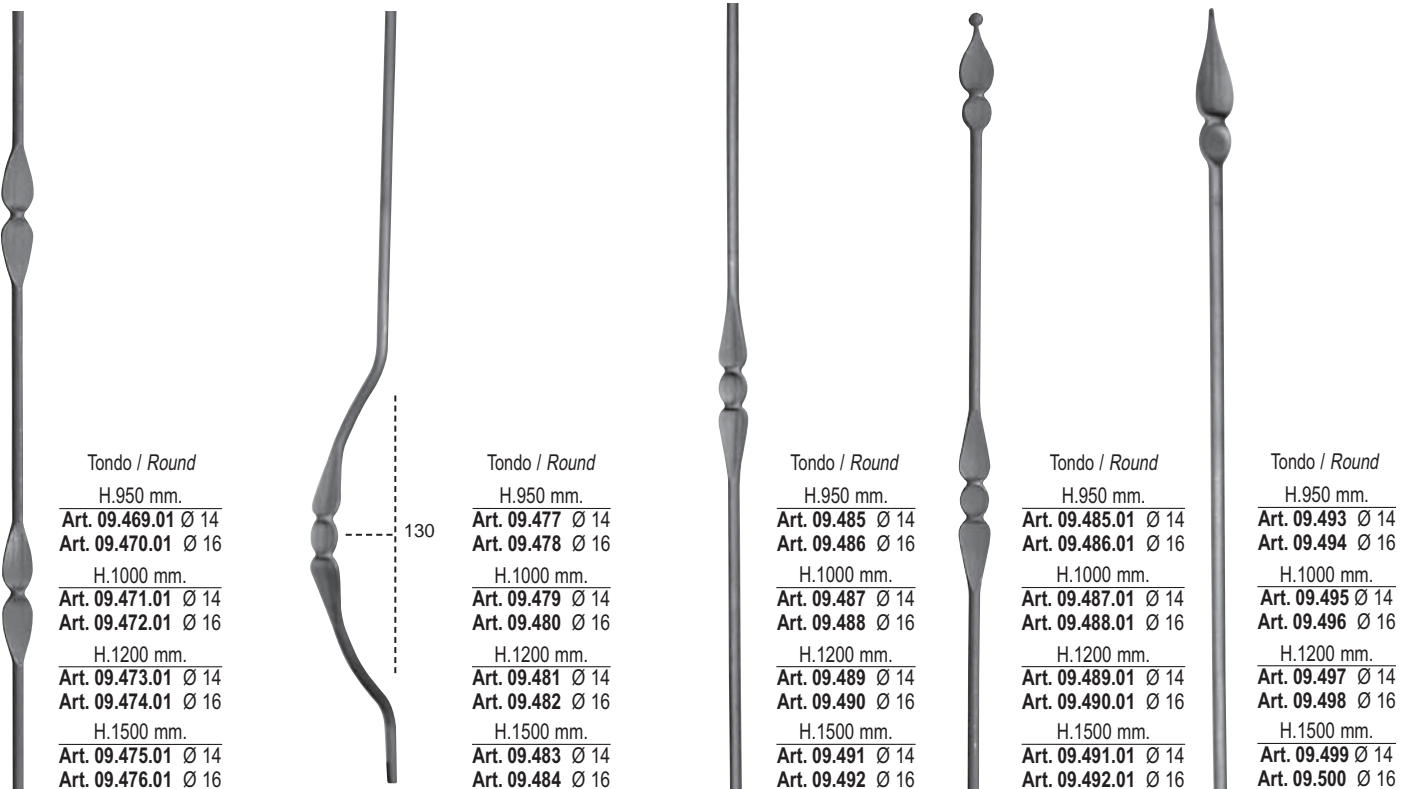
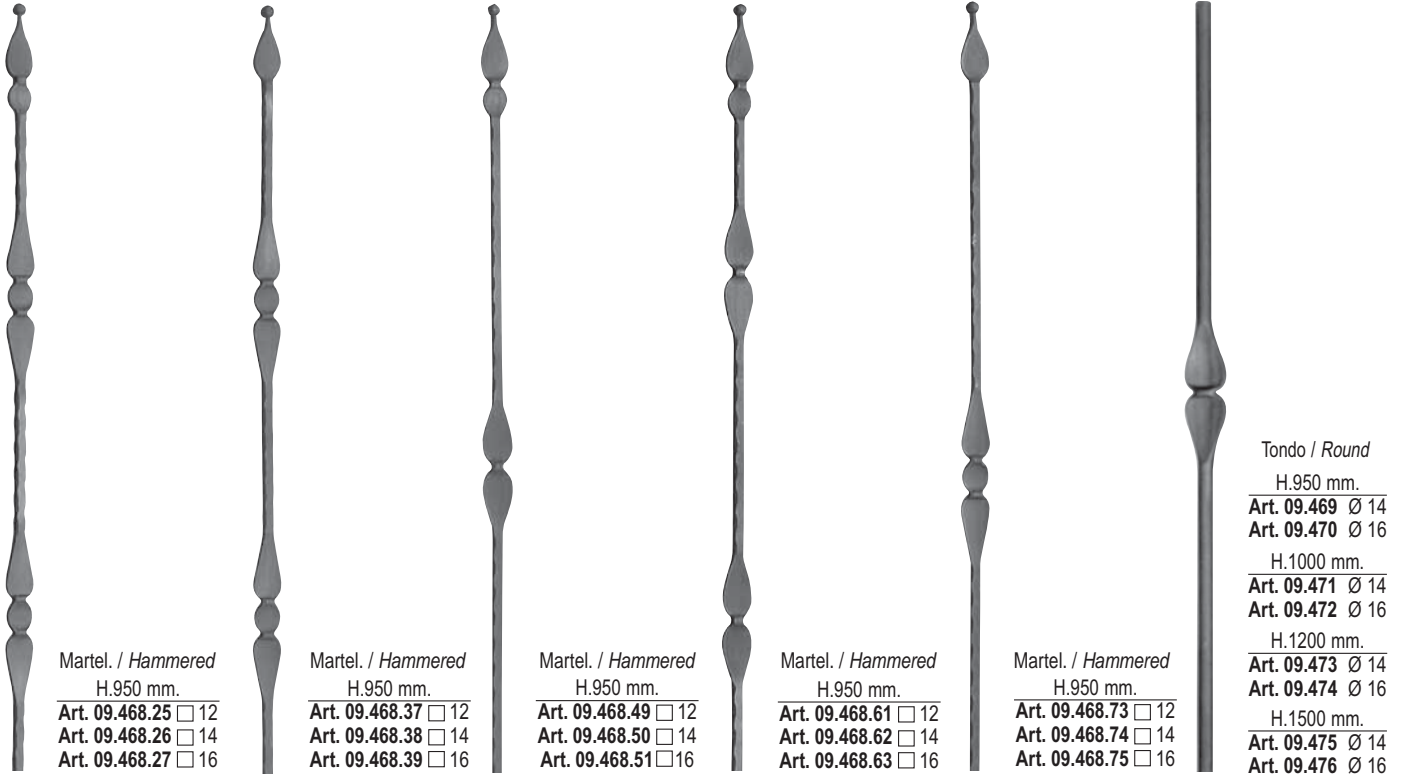

A RICHIESTA CON PALLINA SULLA LANCIA
ON REQUEST WITH BALL ON THE SPEAR



Tondo / Round

H.950 mm.

Art. 09.493.01 Ø 14
Art. 09.494.01 Ø 16

H.1000 mm.

Art. 09.495.01 Ø 14
Art. 09.496.01 Ø 16

H.1200 mm.

Art. 09.497.01 Ø 14
Art. 09.498.01 Ø 16

H.1500 mm.

Art. 09.499.01 Ø 14
Art. 09.500.01 Ø 16



Fiamma grande / Big flame



Tondo / Round

H.950 mm.

Art. 09.500.20 Ø12

H.1000 mm.

Art. 09.500.23 Ø12

H.950 mm.

Art. 09.500.30 □ 12

H.1000 mm.

Art. 09.500.33 □ 12



Tondo / Round

H.950 mm.

Art. 09.501 Ø 14
Art. 09.502 Ø 16

H.1000 mm.

Art. 09.503 Ø 14
Art. 09.504 Ø 16

H.1200 mm.

Art. 09.505 Ø 14
Art. 09.506 Ø 16

H.1500 mm.

Art. 09.507 Ø 14
Art. 09.508 Ø 16



Tondo / Round

Borchia tornita / Turned stud
H.950 mm.

Art. 09.509 Ø 14
Art. 09.509.01 Ø 12

Borchia stampata / Stamped stud
H.950 mm.

Art. 09.509.02 Ø 14
Art. 09.509.03 Ø 12



Tondo / Round

Borchia tornita / Turned stud
H.950 mm.

Art. 09.510 Ø 14
Art. 09.510.07 Ø 12

Borchia stampata / Stamped stud
H.950 mm.

Art. 09.510.10 Ø 14
Art. 09.510.12 Ø 12



H.950 mm.

Art. 09.510.03 □ 14
Art. 09.510.05 □ 12



H.950 mm.

Art. 09.510.04 □ 14
Art. 09.510.06 □ 12



H.1500 mm.

Art. 09.510.08 □ 12
Art. 09.510.09 □ 14



550

H.2000 mm.

Art. 09.510.20 □ 12
Art. 09.510.21 □ 14



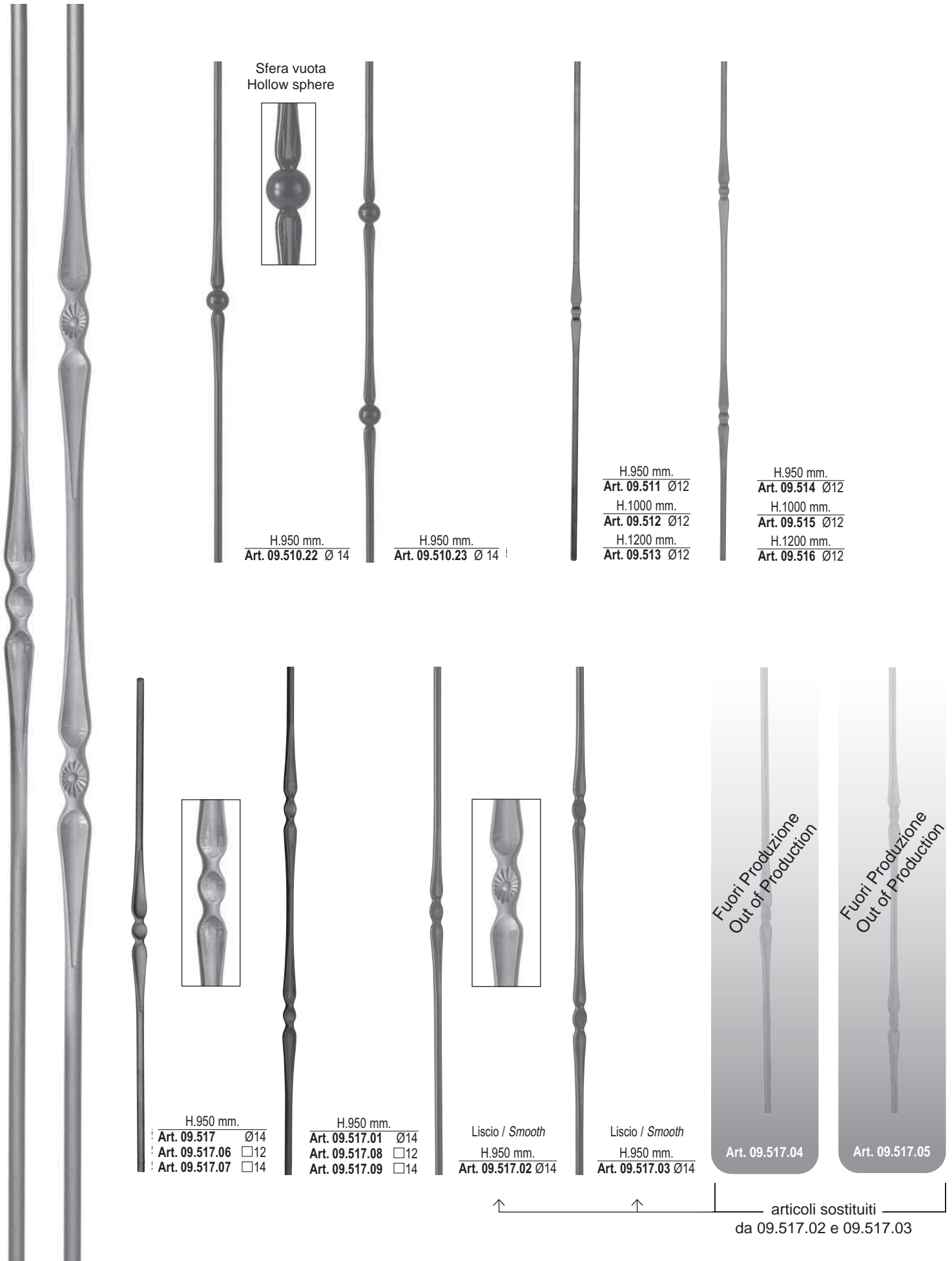

Sfera vuota
Hollow sphere



H.950 mm.
Art. 09.510.22 Ø 14

H.950 mm.
Art. 09.510.23 Ø 14

H.950 mm.
Art. 09.511 Ø12
H.1000 mm.
Art. 09.512 Ø12
H.1200 mm.
Art. 09.513 Ø12

H.950 mm.
Art. 09.514 Ø12
H.1000 mm.
Art. 09.515 Ø12
H.1200 mm.
Art. 09.516 Ø12

H.950 mm.
Art. 09.517 Ø14
Art. 09.517.06 □12
Art. 09.517.07 □14

H.950 mm.
Art. 09.517.01 Ø14
Art. 09.517.08 □12
Art. 09.517.09 □14

Liscio / Smooth
H.950 mm.
Art. 09.517.02 Ø14

Liscio / Smooth
H.950 mm.
Art. 09.517.03 Ø14

Fuori Produzione
Out of Production

Art. 09.517.04

Fuori Produzione
Out of Production

Art. 09.517.05

↑ ↑ articoli sostituiti
da 09.517.02 e 09.517.03



Martellato / Hammered

H.950 mm.
Art. 09.518 □ 12
Art. 09.519 □ 14
Art. 09.520 □ 16
H.1000 mm.
Art. 09.521 □ 12
Art. 09.522 □ 14
Art. 09.523 □ 16
H.1200 mm.
Art. 09.524 □ 12
Art. 09.525 □ 14
Art. 09.526 □ 16



Martellato / Hammered

H.950 mm.
Art. 09.518.01 □ 12
Art. 09.519.01 □ 14
Art. 09.520.01 □ 16
H.1000 mm.
Art. 09.521.01 □ 12
Art. 09.522.01 □ 14
Art. 09.523.01 □ 16
H.1200 mm.
Art. 09.524.01 □ 12
Art. 09.525.01 □ 14
Art. 09.526.01 □ 16



Martellato / Hammered

H.950 mm.
Art. 09.527 □ 12
Art. 09.528 □ 14
Art. 09.529 □ 16
H.1000 mm.
Art. 09.530 □ 12
Art. 09.531 □ 14
Art. 09.532 □ 16
H.1200 mm.
Art. 09.533 □ 12
Art. 09.534 □ 14
Art. 09.535 □ 16



Martellato / Hammered

H.950 mm.
Art. 09.536 □ 12
Art. 09.537 □ 14
Art. 09.538 □ 16
H.1000 mm.
Art. 09.539 □ 12
Art. 09.540 □ 14
Art. 09.541 □ 16
H.1200 mm.
Art. 09.542 □ 12
Art. 09.543 □ 14
Art. 09.544 □ 16



Martellato / Hammered

H.950 mm.
Art. 09.536.01 □ 12
Art. 09.537.01 □ 14
Art. 09.538.01 □ 16



Martellato / Hammered

H.950 mm.
Art. 09.545 □ 12
Art. 09.546 □ 14
Art. 09.547 □ 16
H.1000 mm.
Art. 09.548 □ 12
Art. 09.549 □ 14
Art. 09.550 □ 16
H.1200 mm.
Art. 09.551 □ 12
Art. 09.552 □ 14
Art. 09.553 □ 16



Martellato / Hammered

H.950 mm.
Art. 09.545.01 □ 12
Art. 09.546.01 □ 14
Art. 09.547.01 □ 16



Martellato / Hammered

H.950 mm.
Art. 09.554 □ 12
Art. 09.555 □ 14
Art. 09.556 □ 16
H.1000 mm.
Art. 09.557 □ 12
Art. 09.558 □ 14
Art. 09.559 □ 16
H.1200 mm.
Art. 09.560 □ 12
Art. 09.561 □ 14
Art. 09.562 □ 16



130

Martellato / Hammered

H.950 mm.
Art. 09.563 □ 12
Art. 09.564 □ 14
Art. 09.565 □ 16
H.1000 mm.
Art. 09.566 □ 12
Art. 09.567 □ 14
Art. 09.568 □ 16
H.1200 mm.
Art. 09.569 □ 12
Art. 09.570 □ 14
Art. 09.571 □ 16



Martellato / Hammered

H.950 mm.
Art. 09.572 □ 12
Art. 09.573 □ 14
Art. 09.574 □ 16
H.1000 mm.
Art. 09.575 □ 12
Art. 09.576 □ 14
Art. 09.577 □ 16
H.1200 mm.
Art. 09.578 □ 12
Art. 09.579 □ 14
Art. 09.580 □ 16



H.950 mm.
Art. 09.581 □ 12
Art. 09.582 □ 14
Art. 09.583 □ 16
H.1000 mm.
Art. 09.584 □ 12
Art. 09.585 □ 14
Art. 09.586 □ 16
H.1200 mm.
Art. 09.587 □ 12
Art. 09.588 □ 14
Art. 09.589 □ 16

A RICHIESTA CON PALLINA SULLA LANCIA
ON REQUEST WITH BALL ON THE SPEAR



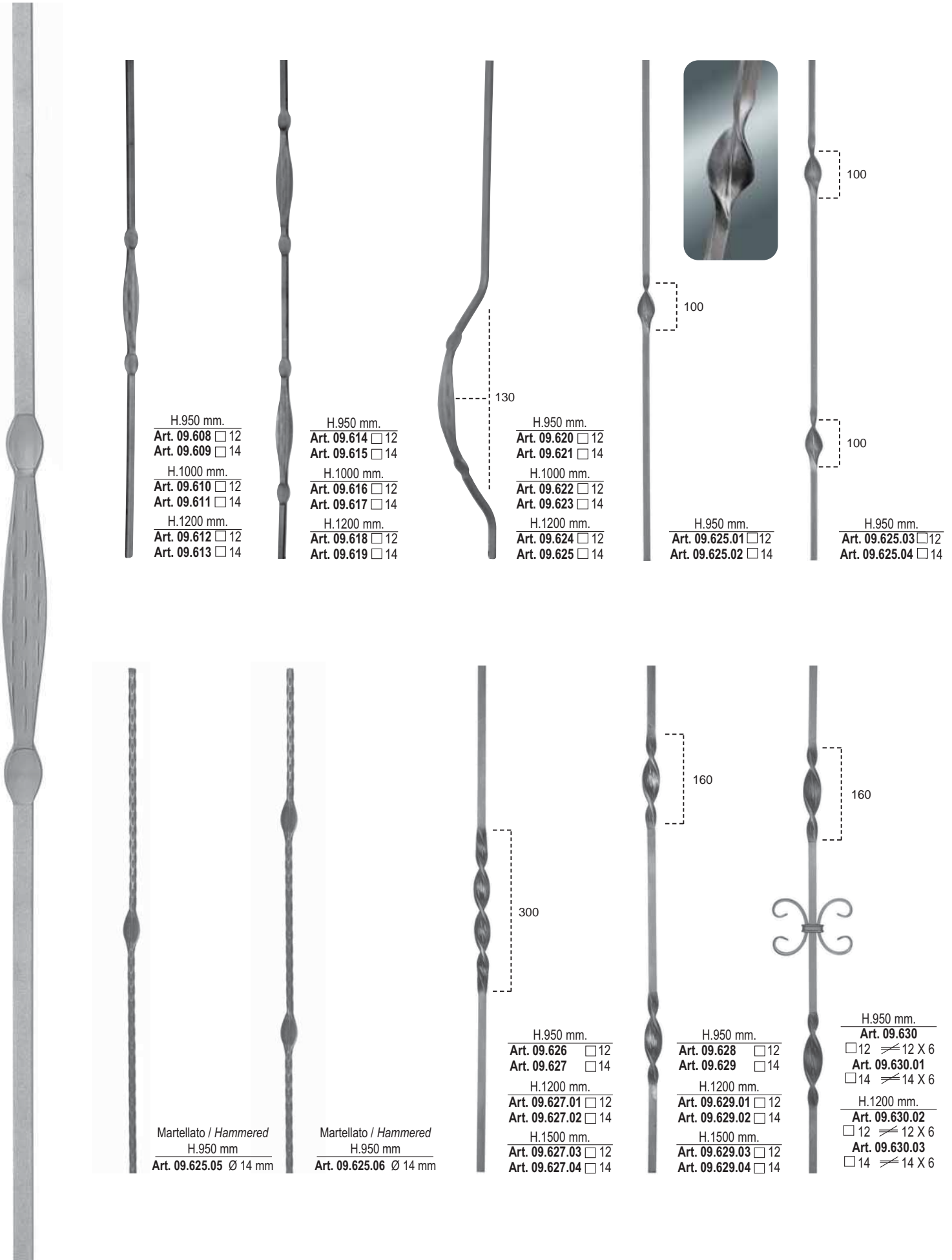

H.950 mm.
Art. 09.608 □ 12
Art. 09.609 □ 14

H.1000 mm.
Art. 09.610 □ 12
Art. 09.611 □ 14

H.1200 mm.
Art. 09.612 □ 12
Art. 09.613 □ 14

H.950 mm.
Art. 09.614 □ 12
Art. 09.615 □ 14

H.1000 mm.
Art. 09.616 □ 12
Art. 09.617 □ 14

H.1200 mm.
Art. 09.618 □ 12
Art. 09.619 □ 14

H.950 mm.
Art. 09.620 □ 12
Art. 09.621 □ 14

H.1000 mm.
Art. 09.622 □ 12
Art. 09.623 □ 14

H.1200 mm.
Art. 09.624 □ 12
Art. 09.625 □ 14

H.950 mm.
Art. 09.625.01 □ 12
Art. 09.625.02 □ 14

H.950 mm.
Art. 09.625.03 □ 12
Art. 09.625.04 □ 14

Martellato / Hammered
H.950 mm
Art. 09.625.05 Ø 14 mm

Martellato / Hammered
H.950 mm
Art. 09.625.06 Ø 14 mm

H.950 mm.
Art. 09.626 □ 12
Art. 09.627 □ 14

H.1200 mm.
Art. 09.627.01 □ 12
Art. 09.627.02 □ 14

H.1500 mm.
Art. 09.627.03 □ 12
Art. 09.627.04 □ 14

H.950 mm.
Art. 09.628 □ 12
Art. 09.629 □ 14

H.1200 mm.
Art. 09.629.01 □ 12
Art. 09.629.02 □ 14

H.1500 mm.
Art. 09.629.03 □ 12
Art. 09.629.04 □ 14

H.950 mm.
Art. 09.630
□ 12 ≙ 12 X 6
Art. 09.630.01
□ 14 ≙ 14 X 6

H.1200 mm.
Art. 09.630.02
□ 12 ≙ 12 X 6
Art. 09.630.03
□ 14 ≙ 14 X 6

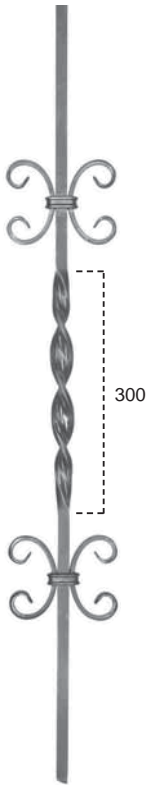

H.950 mm.
Art. 09.631
 12 \neq 12 X 6
Art. 09.631.01
 14 \neq 14 X 6

H.1200 mm.
Art. 09.631.02
 12 \neq 12 X 6
Art. 09.631.03
 14 \neq 14 X 6

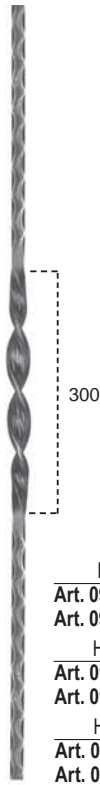

H.950 mm.
Art. 09.631.04 12
Art. 09.631.05 14

H.1200 mm.
Art. 09.631.06 12
Art. 09.631.07 14

H.1500 mm.
Art. 09.631.08 12
Art. 09.631.09 14



H.950 mm.
Art. 09.631.10 12
Art. 09.631.11 14

H.1200 mm.
Art. 09.631.12 12
Art. 09.631.13 14

H.1500 mm.
Art. 09.631.14 12
Art. 09.631.15 14



H.950 mm.
Art. 09.631.16
 12 \neq 12 X 6
Art. 09.631.17
 14 \neq 14 X 6

H.1200 mm.
Art. 09.631.18
 12 \neq 12 X 6
Art. 09.631.19
 14 \neq 14 X 6

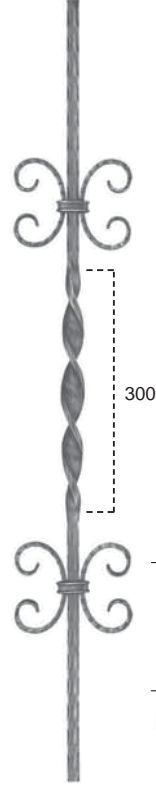

H.950 mm.
Art. 09.631.20
 12 \neq 12 X 6
Art. 09.631.21
 14 \neq 14 X 6

H.1200 mm.
Art. 09.631.22
 12 \neq 12 X 6
Art. 09.631.23
 14 \neq 14 X 6

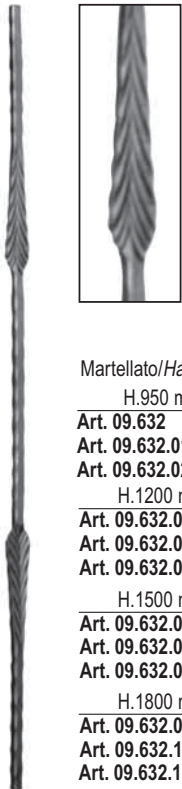

Martellato/Hammered

H.950 mm.
Art. 09.632 12
Art. 09.632.01 14
Art. 09.632.02 16

H.1200 mm.
Art. 09.632.03 12
Art. 09.632.04 14
Art. 09.632.05 16

H.1500 mm.
Art. 09.632.06 12
Art. 09.632.07 14
Art. 09.632.08 16

H.1800 mm.
Art. 09.632.09 12
Art. 09.632.10 14
Art. 09.632.11 16

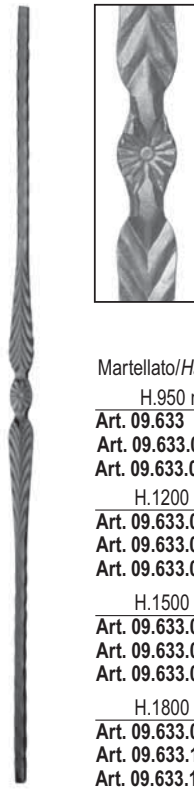

Martellato/Hammered

H.950 mm.
Art. 09.633 12
Art. 09.633.01 14
Art. 09.633.02 16

H.1200 mm.
Art. 09.633.03 12
Art. 09.633.04 14
Art. 09.633.05 16

H.1500 mm.
Art. 09.633.06 12
Art. 09.633.07 14
Art. 09.633.08 16

H.1800 mm.
Art. 09.633.09 12
Art. 09.633.10 14
Art. 09.633.11 16

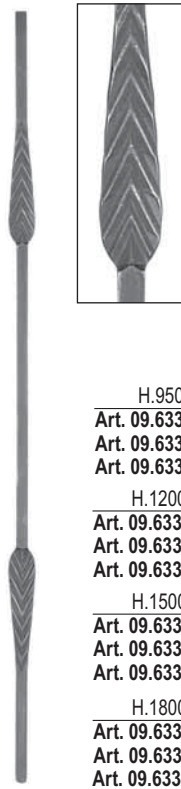

H.950 mm.
Art. 09.633.12 12
Art. 09.633.13 14
Art. 09.633.14 16

H.1200 mm.
Art. 09.633.15 12
Art. 09.633.16 14
Art. 09.633.17 16

H.1500 mm.
Art. 09.633.18 12
Art. 09.633.19 14
Art. 09.633.20 16

H.1800 mm.
Art. 09.633.21 12
Art. 09.633.22 14
Art. 09.633.23 16

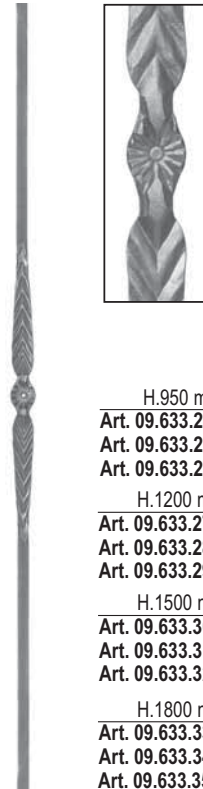

H.950 mm.
Art. 09.633.24 12
Art. 09.633.25 14
Art. 09.633.26 16

H.1200 mm.
Art. 09.633.27 12
Art. 09.633.28 14
Art. 09.633.29 16

H.1500 mm.
Art. 09.633.30 12
Art. 09.633.31 14
Art. 09.633.32 16

H.1800 mm.
Art. 09.633.33 12
Art. 09.633.34 14
Art. 09.633.35 16



Martellato/Hammered
H.1000 X L.140 mm.
Art. 09.634 12
Art. 09.635 14



Martellato/Hammered
H.1000 X L.140 mm.
Art. 09.636 12
Art. 09.637 14



Martellato/Hammered
H.1000 X L.140 mm.
Art. 09.638 12
Art. 09.639 14



Martellato/Hammered
H.950 mm.
Art. 09.640 12
Art. 09.641 14
Art. 09.642 16
H.1000 mm.
Art. 09.643 12
Art. 09.644 14
Art. 09.645 16
H.1200 mm.
Art. 09.646 12
Art. 09.647 14
Art. 09.648 16

Paletti ricalcati / New forged bars



Martellato/Hammered
H.950 mm.
Art. 09.658 12
Art. 09.659 14



Martellato/Hammered
H.950 mm.
Art. 09.660 12
Art. 09.661 14



H.950 mm.
Art. 09.662 12
Art. 09.663 14



H.950 mm.
Art. 09.664 12
Art. 09.665 14



H.950 X L.200mm.
Art. 09.666 Ø14



H.950 X L.200mm.
Art. 09.667 Ø14



A RICHIESTA CON PALLINA SULLA LANCIA
ON REQUEST WITH BALL ON THE SPEAR



Martellato. / *Hammered*

H. 950 X L. 130 mm.

- Art. 09.668 12
- Art. 09.669 14
- Art. 09.669.01 16

H. 1200 X L. 130 mm.

- Art. 09.669.02 12
- Art. 09.669.03 14
- Art. 09.669.04 16

H. 1500 X L. 130 mm.

- Art. 09.669.05 12
- Art. 09.669.06 14
- Art. 09.669.07 16

H. 1800 X L. 130 mm.

- Art. 09.669.08 12
- Art. 09.669.09 14
- Art. 09.669.10 16



H. 950 X L. 130 mm.

Art. 09.671.01 Ø 14



H.950 mm.

- Art. 09.672 12
- Art. 09.673 14
- Art. 09.674 16



H.950 mm.

- Art. 09.684 12
- Art. 09.685 14
- Art. 09.686 16



H.950 mm.

- Art. 09.696 12
- Art. 09.697 14
- Art. 09.698 16



H.950 mm.

- Art. 09.708 12
- Art. 09.709 14
- Art. 09.710 16

H.1200 mm.

- Art. 09.711 12
- Art. 09.712 14
- Art. 09.713 16

H.1500 mm.

- Art. 09.714 12
- Art. 09.715 14
- Art. 09.716 16

H.1800 mm.

- Art. 09.717 12
- Art. 09.718 14
- Art. 09.719 16



Martel./ *Hammered*

H.950 mm.

- Art. 09.720 12
- Art. 09.721 14
- Art. 09.722 16

H.1200 mm.

- Art. 09.723 12
- Art. 09.724 14
- Art. 09.725 16

H.1500 mm.

- Art. 09.726 12
- Art. 09.727 14
- Art. 09.728 16

H.1800 mm.

- Art. 09.729 12
- Art. 09.730 14
- Art. 09.731 16



H.950 mm.

- Art. 09.732 Ø 14
- Art. 09.733 Ø 16

H.1200 mm.

- Art. 09.734 Ø 14
- Art. 09.735 Ø 16

H.1500 mm.

- Art. 09.736 Ø 14
- Art. 09.737 Ø 16

H.1800 mm.

- Art. 09.738 Ø 14
- Art. 09.739 Ø 16

Palline piccole / *Small Balls*



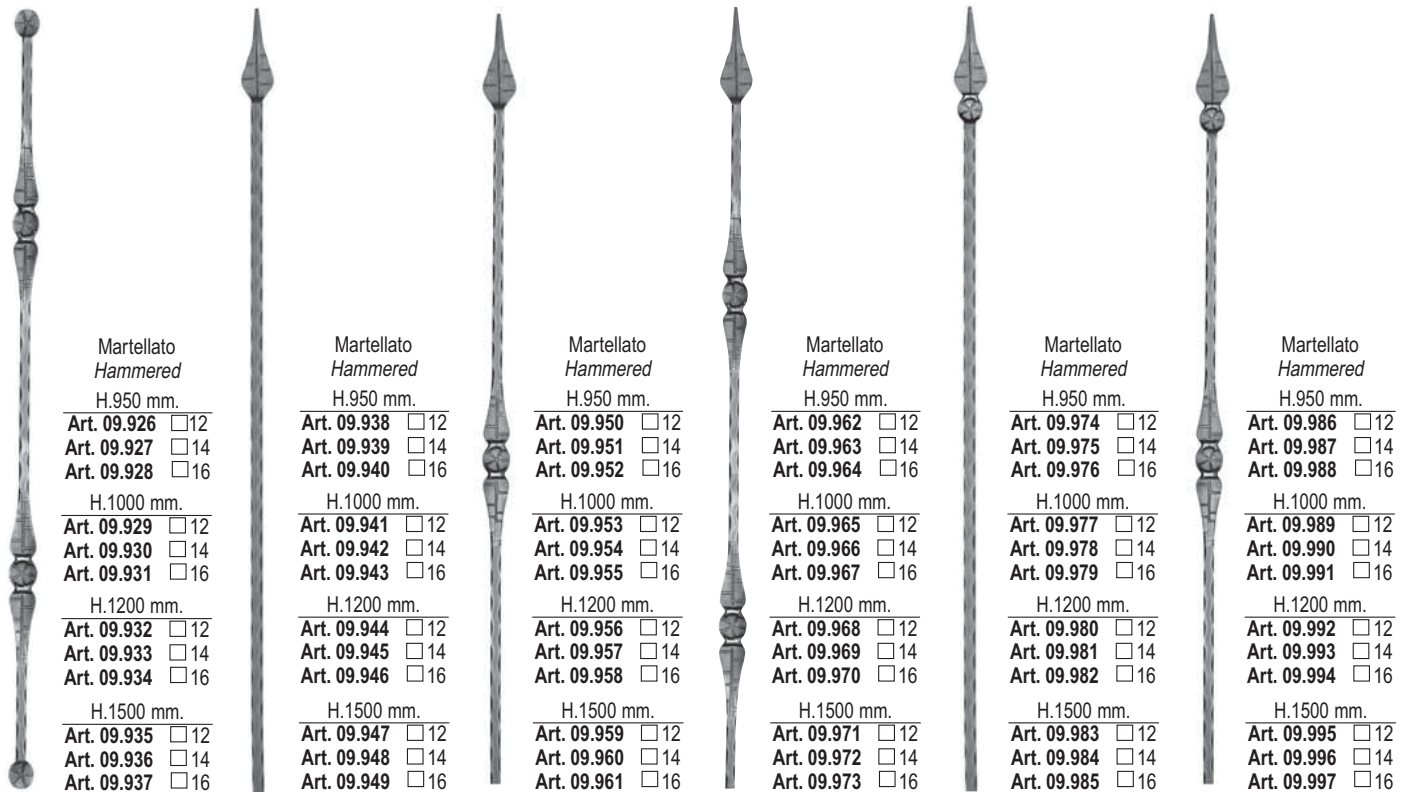
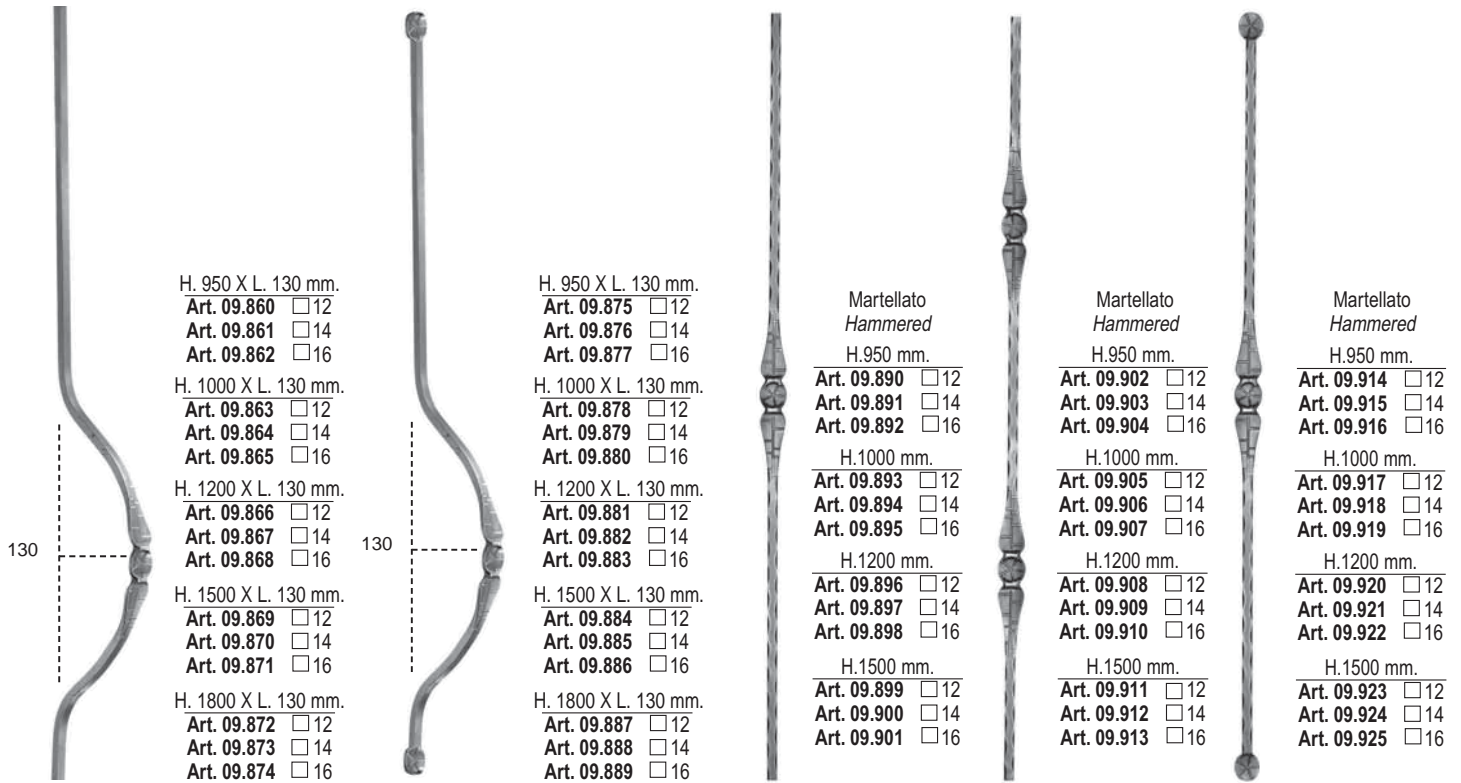

A RICHIESTA CON PALLINA SULLA LANCIA
ON REQUEST WITH BALL ON THE SPEAR





Martellato
Hammered

H.950 mm.
Art. 09.998 12
Art. 09.999 14
Art. 09.999.01 16

H.1000 mm.
Art. 09.999.02 12
Art. 09.999.03 14
Art. 09.999.04 16

H.1200 mm.
Art. 09.999.05 12
Art. 09.999.06 14
Art. 09.999.07 16

H.1500 mm.
Art. 09.999.08 12
Art. 09.999.09 14
Art. 09.999.10 16



Martellato
Hammered

H.950 mm.
Art. 09.999.11 12
Art. 09.999.12 14
Art. 09.999.13 16

H.1000 mm.
Art. 09.999.14 12
Art. 09.999.15 14
Art. 09.999.16 16

H.1200 mm.
Art. 09.999.17 12
Art. 09.999.18 14
Art. 09.999.19 16

H.1500 mm.
Art. 09.999.20 12
Art. 09.999.21 14
Art. 09.999.22 16

H.1800 mm.
Art. 09.999.23 12
Art. 09.999.24 14
Art. 09.999.25 16



Martellato
Hammered

H.950 mm.
Art. 09.999.26 12
Art. 09.999.27 14
Art. 09.999.28 16

H.1000 mm.
Art. 09.999.29 12
Art. 09.999.30 14
Art. 09.999.31 16

H.1200 mm.
Art. 09.999.32 12
Art. 09.999.33 14
Art. 09.999.34 16

H.1500 mm.
Art. 09.999.35 12
Art. 09.999.36 14
Art. 09.999.37 16

H.1800 mm.
Art. 09.999.38 12
Art. 09.999.39 14
Art. 09.999.40 16



Martellato/Hammered

H.950 mm.
Art. 09.1002.01 12
Art. 09.1002.02 14
Art. 09.1002.03 16

H.1000 mm.
Art. 09.1002.04 12
Art. 09.1002.05 14
Art. 09.1002.06 16

H.1200 mm.
Art. 09.1002.08 14
Art. 09.1002.09 16

H.1500 mm.
Art. 09.1002.10 12
Art. 09.1002.11 14
Art. 09.1002.12 16



Liscio / Smooth

H.950 mm.
Art. 09.1003 14
Art. 09.1003.01 16

H.1000 mm.
Art. 09.1003.02 14
Art. 09.1003.03 16

H.1200 mm.
Art. 09.1003.04 14
Art. 09.1003.05 16

H.1500 mm.
Art. 09.1003.06 14
Art. 09.1003.07 16



Liscio / Smooth

H.950 mm.
Art. 09.1004 12
Art. 09.1004.01 14
Art. 09.1004.02 16

H.1000 mm.
Art. 09.1004.03 12
Art. 09.1004.04 14
Art. 09.1004.05 16

H.1200 mm.
Art. 09.1004.06 12
Art. 09.1004.07 14
Art. 09.1004.08 16

H.1500 mm.
Art. 09.1004.09 12
Art. 09.1004.10 14
Art. 09.1004.11 16



Liscio / Smooth

H.950 mm.
Art. 09.1005 12
Art. 09.1005.01 14
Art. 09.1005.02 16

H.1000 mm.
Art. 09.1005.03 12
Art. 09.1005.04 14
Art. 09.1005.05 16

H.1200 mm.
Art. 09.1005.06 12
Art. 09.1005.07 14
Art. 09.1005.08 16

H.1500 mm.
Art. 09.1005.09 12
Art. 09.1005.10 14
Art. 09.1005.11 16



Martellato/Hammered

H.950 mm.
Art. 09.1006 12
Art. 09.1006.01 14
Art. 09.1006.02 16

H.1000 mm.
Art. 09.1006.03 12
Art. 09.1006.04 14
Art. 09.1006.05 16

H.1200 mm.
Art. 09.1006.06 12
Art. 09.1006.07 14
Art. 09.1006.08 16

H.1500 mm.
Art. 09.1006.09 12
Art. 09.1006.10 14
Art. 09.1006.11 16



A RICHIESTA CON PALLINA SULLA LANCIA
ON REQUEST WITH BALL ON THE SPEAR



Liscio / Smooth
H.950 mm.
Art. 09.1007 Ø 12
Art. 09.1007.01 Ø 14

H.1000 mm.
Art. 09.1007.02 Ø 12
Art. 09.1007.03 Ø 14

H.1200 mm.
Art. 09.1007.04 Ø 12
Art. 09.1007.05 Ø 14

H.1500 mm.
Art. 09.1007.06 Ø 12
Art. 09.1007.07 Ø 14



Liscio / Smooth
H.950 mm.
Art. 09.1008 □12



Liscio / Smooth
H.950 mm.
Art. 09.1009 □12





Martellato / Hammered
H.950 mm.
Art. 09.1010 □12



Martellato / Hammered
H.950 mm.
Art. 09.1011 □12



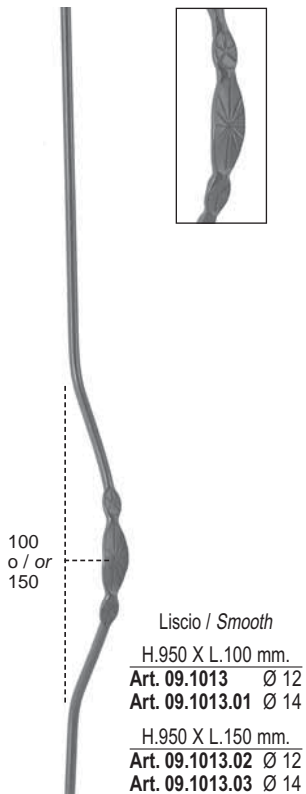

Fuori Produzione
Out of Production
Art. 09.1012

100
o / or
150

Liscio / Smooth
H.950 X L.100 mm.
Art. 09.1013 Ø 12
Art. 09.1013.01 Ø 14

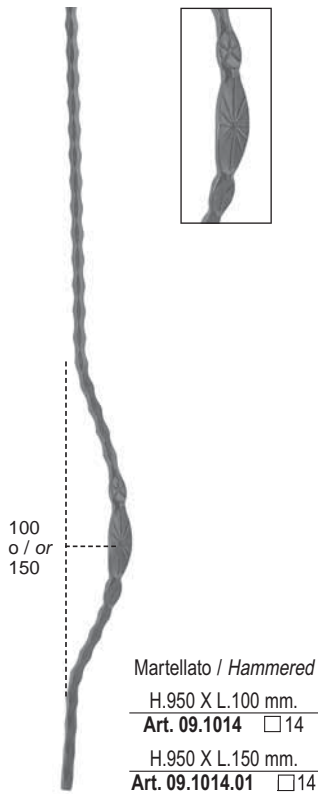

H.950 X L.150 mm.
Art. 09.1013.02 Ø 12
Art. 09.1013.03 Ø 14

100
o / or
150

Martellato / Hammered
H.950 X L.100 mm.
Art. 09.1014 □14

H.950 X L.150 mm.
Art. 09.1014.01 □14

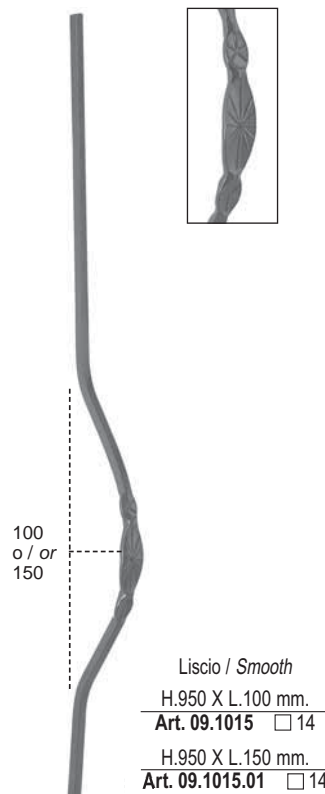



100
o / or
150

Liscio / Smooth
H.950 X L.100 mm.
Art. 09.1015 □14

H.950 X L.150 mm.
Art. 09.1015.01 □14

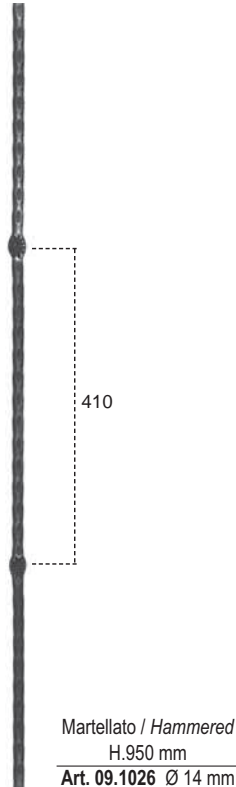
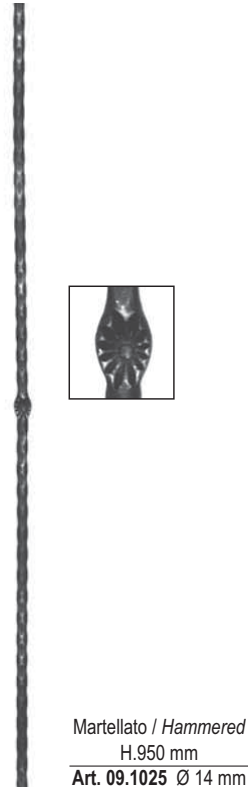
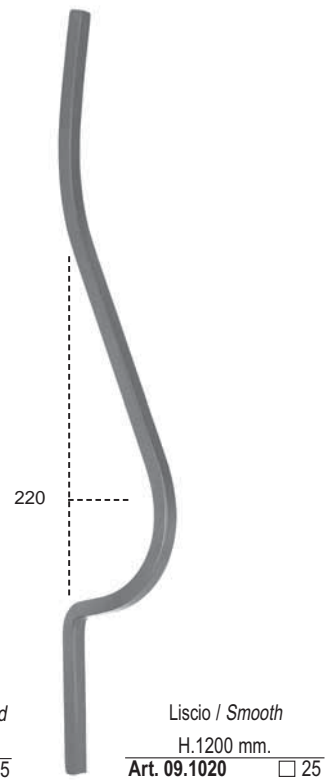
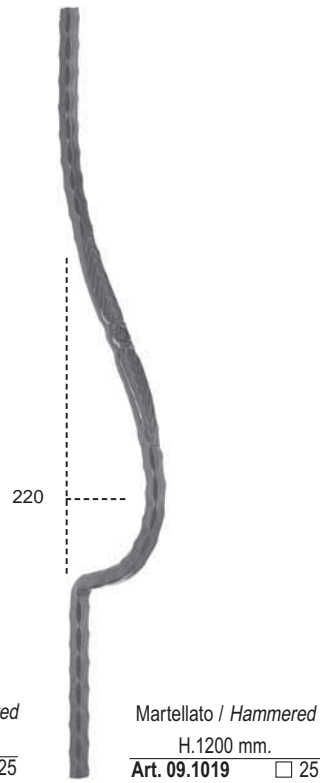
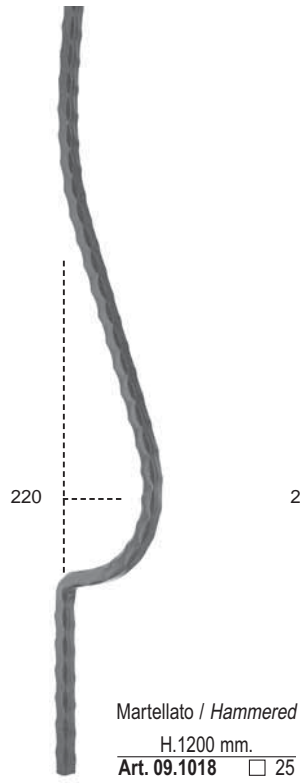
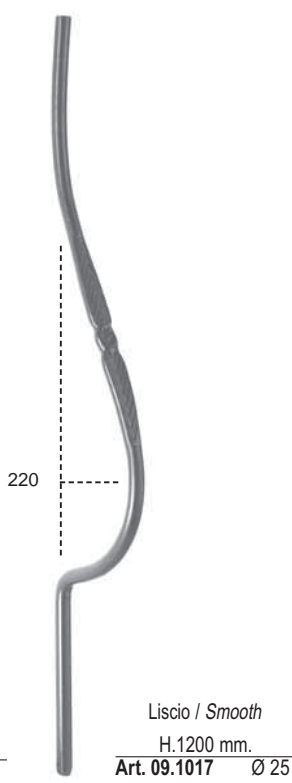
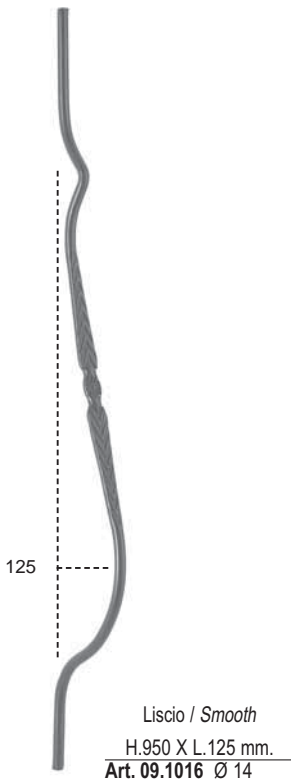





Schiacciata sullo spigolo /
Ornament on the edge
Liscio / Smooth

H 950 mm

Art. 09.1050 12x12 mm
Art. 09.1051 14x14 mm
Art. 09.1052 16x16 mm

H 1000 mm

Art. 09.1053 12x12 mm
Art. 09.1054 14x14 mm
Art. 09.1055 16x16 mm

H 1200 mm

Art. 09.1056 12x12 mm
Art. 09.1057 14x14 mm
Art. 09.1058 16x16 mm



Schiacciata sullo spigolo /
Ornament on the edge
Liscio / Smooth

H 950 mm

Art. 09.1059 12x12 mm
Art. 09.1060 14x14 mm
Art. 09.1061 16x16 mm

H 1000 mm

Art. 09.1062 12x12 mm
Art. 09.1063 14x14 mm
Art. 09.1064 16x16 mm

H 1200 mm

Art. 09.1065 12x12 mm
Art. 09.1066 14x14 mm
Art. 09.1067 16x16 mm



Schiacciata sullo spigolo /
Ornament on the edge
Martellato / Hammered

H 950 mm

Art. 09.1068 12x12 mm
Art. 09.1069 14x14 mm
Art. 09.1070 16x16 mm

H 1000 mm

Art. 09.1071 12x12 mm
Art. 09.1072 14x14 mm
Art. 09.1073 16x16 mm

H 1200 mm

Art. 09.1074 12x12 mm
Art. 09.1075 14x14 mm
Art. 09.1076 16x16 mm



Schiacciata sullo spigolo /
Ornament on the edge
Martellato / Hammered

H 950 mm

Art. 09.1077 12x12 mm
Art. 09.1078 14x14 mm
Art. 09.1079 16x16 mm

H 1000 mm

Art. 09.1080 12x12 mm
Art. 09.1081 14x14 mm
Art. 09.1082 16x16 mm

H 1200 mm

Art. 09.1083 12x12 mm
Art. 09.1084 14x14 mm
Art. 09.1085 16x16 mm



ELEMENTI IN FERRO RICALCATO
NEW FORGED BARS

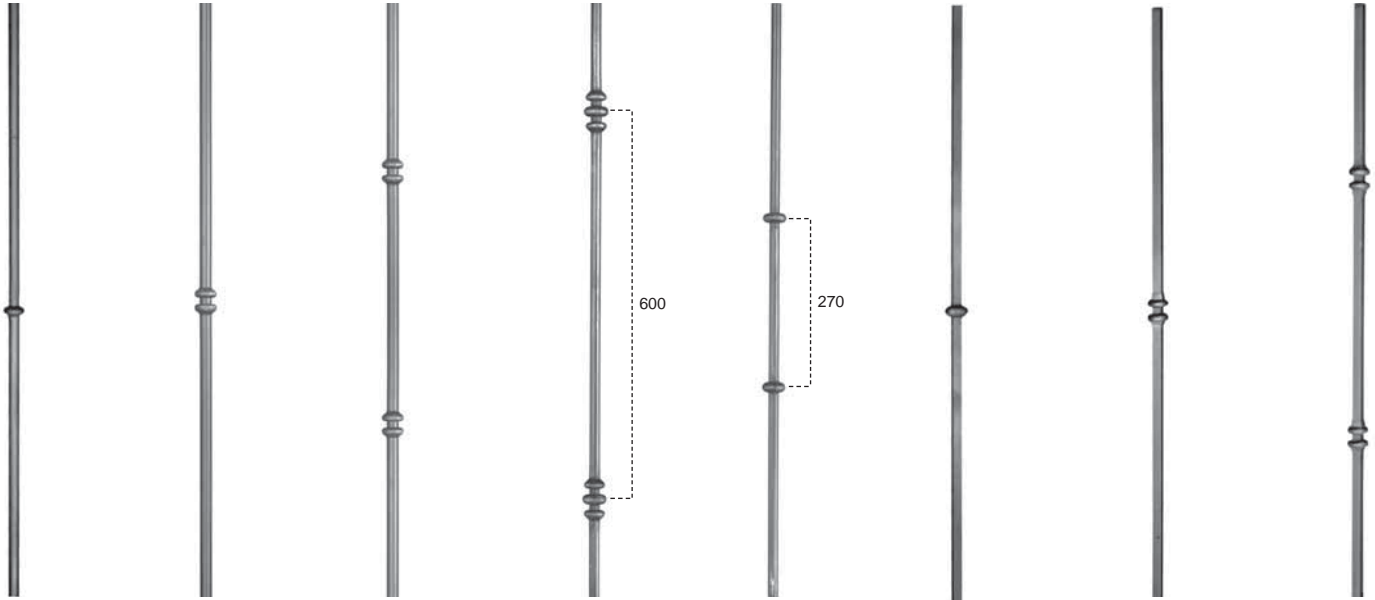

Tondo / Round		Tondo / Round		Tondo / Round		Tondo / Round		Tondo / Round		Tondo / Round		Tondo / Round		Tondo / Round	
H.950 mm.		H.950 mm.		H.950 mm.		H.1500 mm.		H.950 mm.		H.950 mm.		H.950 mm.		H.950 mm.	
Art. 10.001	∅ 16	Art. 10.005	∅ 16	Art. 10.009	∅ 16	Art. 10.012.03	∅ 12	Art. 10.012.09	∅ 12	Art. 10.013	□ 14	Art. 10.017	□ 14	Art. 10.021	□ 14
Art. 10.001.01	∅ 14	Art. 10.005.01	∅ 14	Art. 10.009.01	∅ 14	Art. 10.012.04	∅ 14	Art. 10.012.10	∅ 14	Art. 10.013.01	□ 16	Art. 10.017.01	□ 16	Art. 10.021.01	□ 16
Art. 10.001.02	∅ 12	Art. 10.005.02	∅ 12	Art. 10.009.02	∅ 12	Art. 10.012.05	∅ 16	Art. 10.012.11	∅ 16	Art. 10.013.02	□ 12	Art. 10.017.02	□ 12	Art. 10.021.02	□ 12
H.1000 mm.		H.1000 mm.		H.1000 mm.		H.1800 mm.		H.950 mm.		H.1000 mm.		H.1000 mm.		H.1000 mm.	
Art. 10.002	∅ 16	Art. 10.006	∅ 16	Art. 10.010	∅ 16	Art. 10.012.06	∅ 12	Art. 10.014	□ 14	Art. 10.018	□ 14	Art. 10.018	□ 14	Art. 10.022	□ 14
Art. 10.002.01	∅ 14	Art. 10.006.01	∅ 14	Art. 10.010.01	∅ 14	Art. 10.012.07	∅ 14	Art. 10.014.01	□ 16	Art. 10.018.01	□ 16	Art. 10.018.01	□ 16	Art. 10.022.01	□ 16
Art. 10.002.02	∅ 12	Art. 10.006.02	∅ 12	Art. 10.010.02	∅ 12	Art. 10.012.08	∅ 16	Art. 10.014.02	□ 12	Art. 10.018.02	□ 12	Art. 10.018.02	□ 12	Art. 10.022.02	□ 12
H.1200 mm.		H.1200 mm.		H.1200 mm.				H.1200 mm.		H.1200 mm.		H.1200 mm.		H.1200 mm.	
Art. 10.003	∅ 16	Art. 10.007	∅ 16	Art. 10.011	∅ 16			Art. 10.015	□ 14	Art. 10.019	□ 14	Art. 10.019	□ 14	Art. 10.023	□ 14
Art. 10.003.01	∅ 14	Art. 10.007.01	∅ 14	Art. 10.011.01	∅ 14			Art. 10.015.01	□ 16	Art. 10.019.01	□ 16	Art. 10.019.01	□ 16	Art. 10.023.01	□ 16
Art. 10.003.02	∅ 12	Art. 10.007.02	∅ 12	Art. 10.011.02	∅ 12			Art. 10.015.02	□ 12	Art. 10.019.02	□ 12	Art. 10.019.02	□ 12	Art. 10.023.02	□ 12
H.1500 mm.		H.1500 mm.		H.1500 mm.				H.1500 mm.		H.1500 mm.		H.1500 mm.		H.1500 mm.	
Art. 10.004	∅ 16	Art. 10.008	∅ 16	Art. 10.012	∅ 16			Art. 10.016	□ 14	Art. 10.020	□ 14	Art. 10.020	□ 14	Art. 10.024	□ 14
Art. 10.004.01	∅ 14	Art. 10.008.01	∅ 14	Art. 10.012.01	∅ 14			Art. 10.016.01	□ 16	Art. 10.020.01	□ 16	Art. 10.020.01	□ 16	Art. 10.024.01	□ 16
Art. 10.004.02	∅ 12	Art. 10.008.02	∅ 12	Art. 10.012.02	∅ 12			Art. 10.016.02	□ 12	Art. 10.020.02	□ 12	Art. 10.020.02	□ 12	Art. 10.024.02	□ 12

H.1800 mm.	
Art. 10.020.03	□ 14
Art. 10.020.04	□ 16
H.2000 mm.	
Art. 10.020.05	□ 14
Art. 10.020.06	□ 16

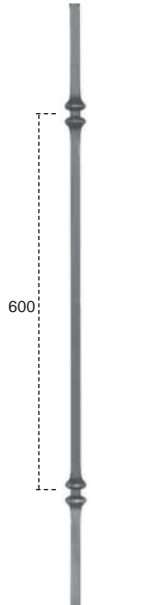
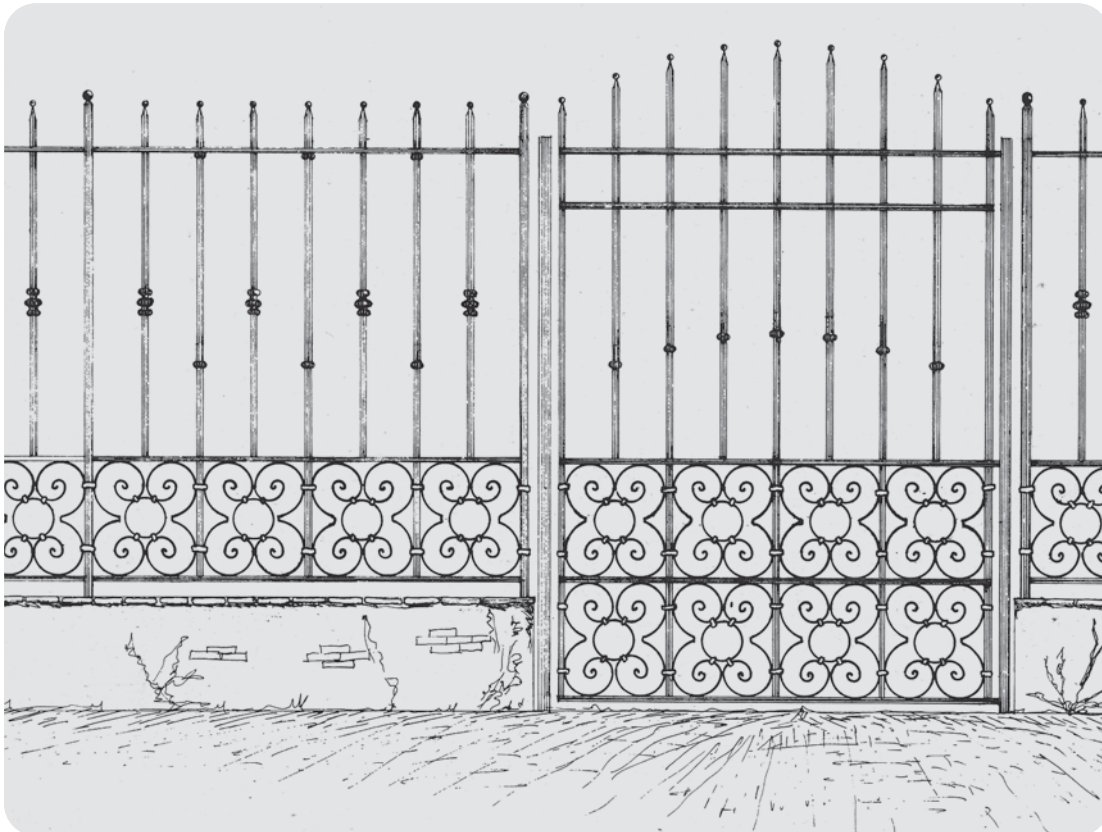

H.1500 mm.	
Art. 10.024.03	□ 14
Art. 10.024.04	□ 16
H.1800 mm.	
Art. 10.024.05	□ 14
Art. 10.024.06	□ 16
H.2000 mm.	
Art. 10.024.07	□ 14
Art. 10.024.08	□ 16

Tutte le parti di questo catalogo - foto comprese - sono di proprietà Euro-Fer. La riproduzione, anche parziale, è vietata in ogni forma e con ogni mezzo. / Every part of this catalogue - photos included - is Euro-Fer's property. All forms of copying are strictly prohibited.

<p>H.950 mm.</p> <p>Art. 10.025 <input type="checkbox"/> 14 Art. 10.025.01 <input type="checkbox"/> 16 Art. 10.025.02 <input type="checkbox"/> 12</p> <p>Art. 10.026 \varnothing 16 Art. 10.026.01 \varnothing 14 Art. 10.026.02 \varnothing 12</p> <p>H.1000 mm.</p> <p>Art. 10.027 <input type="checkbox"/> 14 Art. 10.027.01 <input type="checkbox"/> 16 Art. 10.027.02 <input type="checkbox"/> 12</p> <p>Art. 10.028 \varnothing 16 Art. 10.028.01 \varnothing 14 Art. 10.028.02 \varnothing 12</p> <p>H.1200 mm.</p> <p>Art. 10.029 <input type="checkbox"/> 14 Art. 10.029.01 <input type="checkbox"/> 16 Art. 10.029.02 <input type="checkbox"/> 12</p> <p>Art. 10.030 \varnothing 16 Art. 10.030.01 \varnothing 14 Art. 10.030.02 \varnothing 12</p> <p>H.1500 mm.</p> <p>Art. 10.031 <input type="checkbox"/> 14 Art. 10.031.01 <input type="checkbox"/> 16 Art. 10.031.02 <input type="checkbox"/> 12</p> <p>Art. 10.032 \varnothing 16 Art. 10.032.01 \varnothing 14 Art. 10.032.02 \varnothing 12</p> <p>H.2000 mm.</p> <p>Art. 10.032.18 \varnothing 16</p> <p>H.2500 mm. NEW</p> <p>Art. 10.032.20 <input type="checkbox"/> 14 Art. 10.032.21 <input type="checkbox"/> 16</p>	<p>H.950 mm.</p> <p>Art. 10.033 <input type="checkbox"/> 14 Art. 10.033.01 <input type="checkbox"/> 16 Art. 10.033.02 <input type="checkbox"/> 12</p> <p>Art. 10.034 \varnothing 16 Art. 10.034.01 \varnothing 14 Art. 10.034.02 \varnothing 12</p> <p>H.1000 mm.</p> <p>Art. 10.035 <input type="checkbox"/> 14 Art. 10.035.01 <input type="checkbox"/> 16 Art. 10.035.02 <input type="checkbox"/> 12</p> <p>Art. 10.036 \varnothing 16 Art. 10.036.01 \varnothing 14 Art. 10.036.02 \varnothing 12</p> <p>H.1200 mm.</p> <p>Art. 10.037 <input type="checkbox"/> 14 Art. 10.037.01 <input type="checkbox"/> 16 Art. 10.037.02 <input type="checkbox"/> 12</p> <p>Art. 10.038 \varnothing 16 Art. 10.038.01 \varnothing 14 Art. 10.038.02 \varnothing 12</p> <p>H.1500 mm.</p> <p>Art. 10.039 <input type="checkbox"/> 14 Art. 10.039.01 <input type="checkbox"/> 16 Art. 10.039.02 <input type="checkbox"/> 12</p> <p>Art. 10.040 \varnothing 16 Art. 10.040.01 \varnothing 14 Art. 10.040.02 \varnothing 12</p>	<p>Martellato / Hammered</p> <p>H.950 mm.</p> <p>Art. 10.040.03 <input type="checkbox"/> 12 Art. 10.040.04 <input type="checkbox"/> 14 Art. 10.040.05 <input type="checkbox"/> 16</p> <p>H.1000 mm.</p> <p>Art. 10.040.06 <input type="checkbox"/> 12 Art. 10.040.07 <input type="checkbox"/> 14 Art. 10.040.08 <input type="checkbox"/> 16</p> <p>H.1200 mm.</p> <p>Art. 10.040.09 <input type="checkbox"/> 12 Art. 10.040.10 <input type="checkbox"/> 14 Art. 10.040.11 <input type="checkbox"/> 16</p> <p>H.1500 mm.</p> <p>Art. 10.040.12 <input type="checkbox"/> 12 Art. 10.040.13 <input type="checkbox"/> 14 Art. 10.040.14 <input type="checkbox"/> 16</p>	<p>Martellato / Hammered</p> <p>H.950 mm.</p> <p>Art. 10.040.15 <input type="checkbox"/> 12 Art. 10.040.16 <input type="checkbox"/> 14 Art. 10.040.17 <input type="checkbox"/> 16</p> <p>H.1000 mm.</p> <p>Art. 10.040.18 <input type="checkbox"/> 12 Art. 10.040.19 <input type="checkbox"/> 14 Art. 10.040.20 <input type="checkbox"/> 16</p> <p>H.1200 mm.</p> <p>Art. 10.040.21 <input type="checkbox"/> 12 Art. 10.040.22 <input type="checkbox"/> 14 Art. 10.040.23 <input type="checkbox"/> 16</p> <p>H.1500 mm.</p> <p>Art. 10.040.24 <input type="checkbox"/> 12 Art. 10.040.25 <input type="checkbox"/> 14 Art. 10.040.26 <input type="checkbox"/> 16</p>	<p>Martellato / Hammered</p> <p>H.950 mm.</p> <p>Art. 10.041 <input type="checkbox"/> 14 Art. 10.041.01 <input type="checkbox"/> 16 Art. 10.041.02 <input type="checkbox"/> 12</p> <p>H.1000 mm.</p> <p>Art. 10.042 <input type="checkbox"/> 14 Art. 10.042.01 <input type="checkbox"/> 16 Art. 10.042.02 <input type="checkbox"/> 12</p> <p>H.1200 mm.</p> <p>Art. 10.043 <input type="checkbox"/> 14 Art. 10.043.01 <input type="checkbox"/> 16 Art. 10.043.02 <input type="checkbox"/> 12</p> <p>H.1500 mm.</p> <p>Art. 10.044 <input type="checkbox"/> 14 Art. 10.044.01 <input type="checkbox"/> 16 Art. 10.044.02 <input type="checkbox"/> 12</p>	<p>Martellato / Hammered</p> <p>H.950 mm.</p> <p>Art. 10.045 <input type="checkbox"/> 14 Art. 10.045.01 <input type="checkbox"/> 16 Art. 10.045.02 <input type="checkbox"/> 12</p> <p>H.1000 mm.</p> <p>Art. 10.046 <input type="checkbox"/> 14 Art. 10.046.01 <input type="checkbox"/> 16 Art. 10.046.02 <input type="checkbox"/> 12</p> <p>H.1200 mm.</p> <p>Art. 10.047 <input type="checkbox"/> 14 Art. 10.047.01 <input type="checkbox"/> 16 Art. 10.047.02 <input type="checkbox"/> 12</p> <p>H.1500 mm.</p> <p>Art. 10.048 <input type="checkbox"/> 14 Art. 10.048.01 <input type="checkbox"/> 16 Art. 10.048.02 <input type="checkbox"/> 12</p>
--	--	---	---	---	---



Paletti ricalcati - Tendenze Odierne / New forged bars - Modern Design

<p>Martellato/Hammered</p> <p>H.950 mm.</p> <p>Art. 09.658 <input type="checkbox"/> 12 Art. 09.659 <input type="checkbox"/> 14</p>	<p>Martellato/Hammered</p> <p>H.950 mm.</p> <p>Art. 09.660 <input type="checkbox"/> 12 Art. 09.661 <input type="checkbox"/> 14</p>	<p>H.950 mm.</p> <p>Art. 09.662 <input type="checkbox"/> 12 Art. 09.663 <input type="checkbox"/> 14</p>	<p>H.950 mm.</p> <p>Art. 09.664 <input type="checkbox"/> 12 Art. 09.665 <input type="checkbox"/> 14</p>

Tutte le parti di questo catalogo - foto comprese - sono di proprietà Euro-Fer. La riproduzione, anche parziale, è vietata in ogni forma e con ogni mezzo. / Every part of this catalogue - photos included - is Euro-Fer's property. All forms of copying are strictly prohibited.

ELEMENTI IN FERRO RICALCATO NEW FORGED BARS

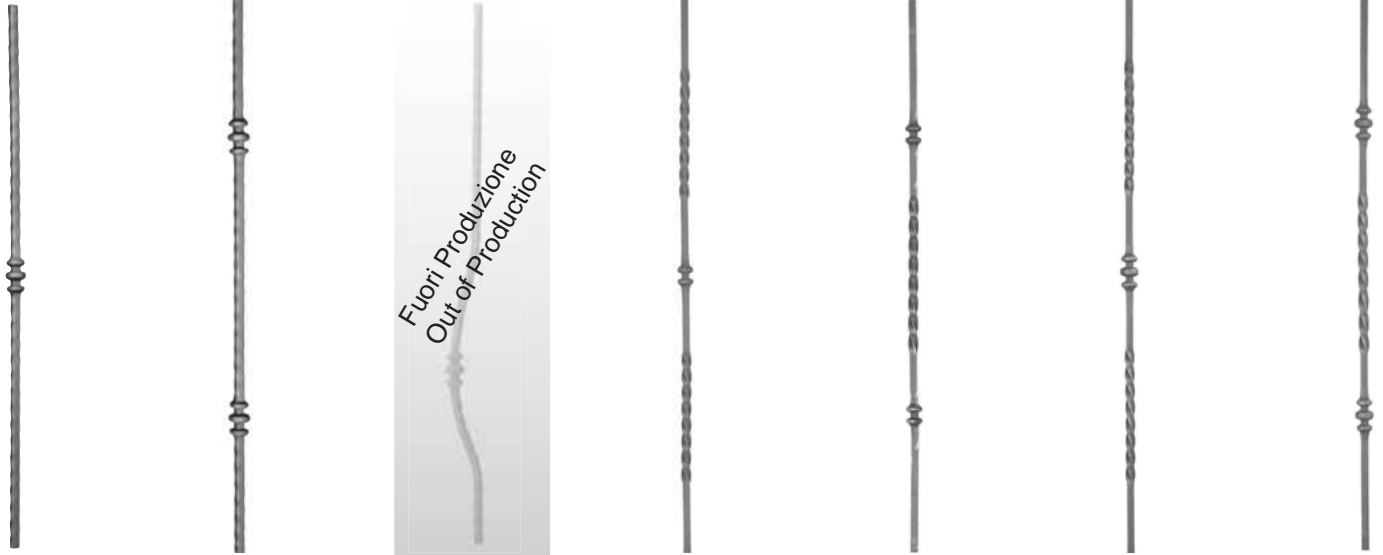

Fuori Produzione
Out of Production

Martellato/Hammered

H.950 mm.
Art. 10.049 14
Art. 10.049.01 16
Art. 10.049.02 12

H.1000 mm.
Art. 10.050 14
Art. 10.050.01 16
Art. 10.050.02 12

H.1200 mm.
Art. 10.051 14
Art. 10.051.01 16
Art. 10.051.02 12

H.1500 mm.
Art. 10.052 14
Art. 10.052.01 16
Art. 10.052.02 12

H.1800 mm.
Art. 10.052.03 12
Art. 10.052.04 14
Art. 10.052.05 16

H.2000 mm.
Art. 10.052.06 12
Art. 10.052.07 14
Art. 10.052.08 16

Martellato/Hammered

H.950 mm.
Art. 10.053 14
Art. 10.053.01 16
Art. 10.053.02 12

H.1000 mm.
Art. 10.054 14
Art. 10.054.01 16
Art. 10.054.02 12

H.1200 mm.
Art. 10.055 14
Art. 10.055.01 16
Art. 10.055.02 12

H.1500 mm.
Art. 10.056 14
Art. 10.056.01 16
Art. 10.056.02 12

Art. 10.056.03
Art. 10.056.04
Art. 10.056.05

Art. 10.056.06
Art. 10.056.07
Art. 10.056.08

Art. 10.056.09
Art. 10.056.10
Art. 10.056.11

Art. 10.056.12
Art. 10.056.13
Art. 10.056.14

H.950 mm.
Art. 10.056.15 12
Art. 10.056.16 14
Art. 10.056.17 16

H.1000 mm.
Art. 10.056.18 12
Art. 10.056.19 14
Art. 10.056.20 16

H.1200 mm.
Art. 10.056.21 12
Art. 10.056.22 14
Art. 10.056.23 16

H.1500 mm.
Art. 10.056.24 12
Art. 10.056.25 14
Art. 10.056.26 16

H.950 mm.
Art. 10.056.27 12
Art. 10.056.28 14
Art. 10.056.29 16

H.1000 mm.
Art. 10.056.30 12
Art. 10.056.31 14
Art. 10.056.32 16

H.1200 mm.
Art. 10.056.33 12
Art. 10.056.34 14
Art. 10.056.35 16

H.1500 mm.
Art. 10.056.36 12
Art. 10.056.37 14
Art. 10.056.38 16

H.950 mm.
Art. 10.056.39 12
Art. 10.056.40 14
Art. 10.056.41 16

H.1000 mm.
Art. 10.056.42 12
Art. 10.056.43 14
Art. 10.056.44 16

H.1200 mm.
Art. 10.056.45 12
Art. 10.056.46 14
Art. 10.056.47 16

H.1500 mm.
Art. 10.056.48 12
Art. 10.056.49 14
Art. 10.056.50 16





H.950 mm.
Art. 10.056.51 12
Art. 10.056.52 14
Art. 10.056.53 16

H.1000 mm.
Art. 10.056.54 12
Art. 10.056.55 14
Art. 10.056.56 16

H.1200 mm.
Art. 10.056.57 12
Art. 10.056.58 14
Art. 10.056.59 16

H.1500 mm.
Art. 10.056.60 12
Art. 10.056.61 14
Art. 10.056.62 16

PALLINE GRANDI / LARGE BALLS













 <p>H.950 mm. Art. 10.057 <input type="checkbox"/>14 Art. 10.057.01 <input type="checkbox"/>16 Art. 10.057.02 <input type="checkbox"/>12</p> <p>H.1000 mm. Art. 10.058 <input type="checkbox"/>14 Art. 10.058.01 <input type="checkbox"/>16 Art. 10.058.02 <input type="checkbox"/>12</p> <p>H.1200 mm. Art. 10.059 <input type="checkbox"/>14 Art. 10.059.01 <input type="checkbox"/>16 Art. 10.059.02 <input type="checkbox"/>12</p> <p>H.1400 mm. Art. 10.059.10 <input type="checkbox"/>14 NEW</p> <p>H.1500 mm. Art. 10.060 <input type="checkbox"/>14 Art. 10.060.01 <input type="checkbox"/>16 Art. 10.060.02 <input type="checkbox"/>12</p> <p>H.1700 mm. Art. 10.060.10 <input type="checkbox"/>14 NEW</p>	 <p>H.950 mm. Art. 10.061 <input type="checkbox"/>14 Art. 10.061.01 <input type="checkbox"/>16 Art. 10.061.02 <input type="checkbox"/>12</p> <p>Art. 10.062 <input type="checkbox"/>16 Art. 10.062.01 <input type="checkbox"/>14 Art. 10.062.02 <input type="checkbox"/>12</p> <p>H.1000 mm. Art. 10.063 <input type="checkbox"/>14 Art. 10.063.01 <input type="checkbox"/>16 Art. 10.063.02 <input type="checkbox"/>12</p> <p>Art. 10.064 <input type="checkbox"/>16 Art. 10.064.01 <input type="checkbox"/>14 Art. 10.064.02 <input type="checkbox"/>12</p> <p>H.1200 mm. Art. 10.065 <input type="checkbox"/>14 Art. 10.065.01 <input type="checkbox"/>16 Art. 10.065.02 <input type="checkbox"/>12</p> <p>Art. 10.066 <input type="checkbox"/>16 Art. 10.066.01 <input type="checkbox"/>14 Art. 10.066.02 <input type="checkbox"/>12</p> <p>H.1500 mm. Art. 10.067 <input type="checkbox"/>14 Art. 10.067.01 <input type="checkbox"/>16 Art. 10.067.02 <input type="checkbox"/>12</p> <p>Art. 10.068 <input type="checkbox"/>16 Art. 10.068.01 <input type="checkbox"/>14 Art. 10.068.02 <input type="checkbox"/>12</p>	 <p>H.950 mm. Art. 10.068.60 <input type="checkbox"/>14 Art. 10.068.61 <input type="checkbox"/>12</p> <p>H.1000 mm. Art. 10.068.62 <input type="checkbox"/>14 Art. 10.068.63 <input type="checkbox"/>12</p> <p>H.1200 mm. Art. 10.068.64 <input type="checkbox"/>14 Art. 10.068.65 <input type="checkbox"/>12</p> <p>H.1500 mm. Art. 10.068.66 <input type="checkbox"/>14 Art. 10.068.67 <input type="checkbox"/>12</p>	 <p>H.950 mm. Art. 10.069 <input type="checkbox"/>14 Art. 10.069.01 <input type="checkbox"/>16 Art. 10.069.02 <input type="checkbox"/>12</p> <p>Art. 10.070 <input type="checkbox"/>16 Art. 10.070.01 <input type="checkbox"/>14 Art. 10.070.02 <input type="checkbox"/>12</p> <p>H.1000 mm. Art. 10.071 <input type="checkbox"/>14 Art. 10.071.01 <input type="checkbox"/>16 Art. 10.071.02 <input type="checkbox"/>12</p> <p>Art. 10.072 <input type="checkbox"/>16 Art. 10.072.01 <input type="checkbox"/>14 Art. 10.072.02 <input type="checkbox"/>12</p> <p>H.1200 mm. Art. 10.073 <input type="checkbox"/>14 Art. 10.073.01 <input type="checkbox"/>16 Art. 10.073.02 <input type="checkbox"/>12</p> <p>Art. 10.074 <input type="checkbox"/>16 Art. 10.074.01 <input type="checkbox"/>14 Art. 10.074.02 <input type="checkbox"/>12</p> <p>H.1500 mm. Art. 10.075 <input type="checkbox"/>14 Art. 10.075.01 <input type="checkbox"/>16 Art. 10.075.02 <input type="checkbox"/>12</p> <p>Art. 10.076 <input type="checkbox"/>16 Art. 10.076.01 <input type="checkbox"/>14 Art. 10.076.02 <input type="checkbox"/>12</p>	 <p>H.950 mm. Art. 10.077 <input type="checkbox"/>14 Art. 10.077.01 <input type="checkbox"/>16 Art. 10.077.02 <input type="checkbox"/>12</p> <p>Art. 10.078 <input type="checkbox"/>16 Art. 10.078.01 <input type="checkbox"/>14 Art. 10.078.02 <input type="checkbox"/>12</p> <p>H.1000 mm. Art. 10.079 <input type="checkbox"/>14 Art. 10.079.01 <input type="checkbox"/>16 Art. 10.079.02 <input type="checkbox"/>12</p> <p>Art. 10.080 <input type="checkbox"/>16 Art. 10.080.01 <input type="checkbox"/>14 Art. 10.080.02 <input type="checkbox"/>12</p> <p>H.1200 mm. Art. 10.081 <input type="checkbox"/>14 Art. 10.081.01 <input type="checkbox"/>16 Art. 10.081.02 <input type="checkbox"/>12</p> <p>Art. 10.082 <input type="checkbox"/>16 Art. 10.082.01 <input type="checkbox"/>14 Art. 10.082.02 <input type="checkbox"/>12</p> <p>H.1500 mm. Art. 10.083 <input type="checkbox"/>14 Art. 10.083.01 <input type="checkbox"/>16 Art. 10.083.02 <input type="checkbox"/>12</p> <p>Art. 10.084 <input type="checkbox"/>16 Art. 10.084.01 <input type="checkbox"/>14 Art. 10.084.02 <input type="checkbox"/>12</p>
---	--	--	---	--

ELEMENTI IN FERRO RICALCATO NEW FORGED BARS

10

PALLINE GRANDI / LARGE BALLS

NEW

						
H.950 mm. Art. 10.085 □ 14 Art. 10.085.01 □ 16 Art. 10.085.02 □ 12 Art. 10.086 Ø 16 Art. 10.086.01 Ø 14 Art. 10.086.02 Ø 12	H.950 mm. Art. 10.093 □ 14 Art. 10.093.01 □ 16 Art. 10.093.02 □ 12 Art. 10.094 Ø 16 Art. 10.094.01 Ø 14 Art. 10.094.02 Ø 12	H.950 mm. Art. 10.101 □ 14 Art. 10.101.01 □ 16 Art. 10.101.02 □ 12 Art. 10.102 Ø 16 Art. 10.102.01 Ø 14 Art. 10.102.02 Ø 12	H.950 mm. Art. 10.108.60 □ 14 Art. 10.108.61 □ 16 Art. 10.108.62 □ 12 Art. 10.108.63 Ø 16 Art. 10.108.64 Ø 14 Art. 10.108.65 Ø 12	H.1000 mm. Art. 10.108.106 □ 14 Art. 10.108.108 □ 12	H.950 mm. Art. 10.109 □ 14 Art. 10.109.01 □ 16 Art. 10.109.02 □ 12 Art. 10.110 Ø 16 Art. 10.110.01 Ø 14 Art. 10.110.02 Ø 12	H.950 mm. Art. 10.117 □ 14 Art. 10.117.01 □ 16 Art. 10.117.02 □ 12 Art. 10.118 Ø 16 Art. 10.118.01 Ø 14 Art. 10.118.02 Ø 12
H.1000 mm. Art. 10.087 □ 14 Art. 10.087.01 □ 16 Art. 10.087.02 □ 12 Art. 10.088 Ø 16 Art. 10.088.01 Ø 14 Art. 10.088.02 Ø 12	H.1000 mm. Art. 10.095 □ 14 Art. 10.095.01 □ 16 Art. 10.095.02 □ 12 Art. 10.096 Ø 16 Art. 10.096.01 Ø 14 Art. 10.096.02 Ø 12	H.1000 mm. Art. 10.103 □ 14 Art. 10.103.01 □ 16 Art. 10.103.02 □ 12 Art. 10.104 Ø 16 Art. 10.104.01 Ø 14 Art. 10.104.02 Ø 12	H.1000 mm. Art. 10.108.66 □ 14 Art. 10.108.67 □ 16 Art. 10.108.68 □ 12 Art. 10.108.69 Ø 16 Art. 10.108.70 Ø 14 Art. 10.108.71 Ø 12	H.1000 mm. Art. 10.108.72 □ 14 Art. 10.108.73 □ 16 Art. 10.108.74 □ 12 Art. 10.108.75 Ø 16 Art. 10.108.76 Ø 14 Art. 10.108.77 Ø 12	H.1000 mm. Art. 10.111 □ 14 Art. 10.111.01 □ 16 Art. 10.111.02 □ 12 Art. 10.112 Ø 16 Art. 10.112.01 Ø 14 Art. 10.112.02 Ø 12	H.1000 mm. Art. 10.119 □ 14 Art. 10.119.01 □ 16 Art. 10.119.02 □ 12 Art. 10.120 Ø 16 Art. 10.120.01 Ø 14 Art. 10.120.02 Ø 12
H.1200 mm. Art. 10.089 □ 14 Art. 10.089.01 □ 16 Art. 10.089.02 □ 12 Art. 10.090 Ø 16 Art. 10.090.01 Ø 14 Art. 10.090.02 Ø 12	H.1200 mm. Art. 10.097 □ 14 Art. 10.097.01 □ 16 Art. 10.097.02 □ 12 Art. 10.098 Ø 16 Art. 10.098.01 Ø 14 Art. 10.098.02 Ø 12	H.1200 mm. Art. 10.105 □ 14 Art. 10.105.01 □ 16 Art. 10.105.02 □ 12 Art. 10.106 Ø 16 Art. 10.106.01 Ø 14 Art. 10.106.02 Ø 12	H.1200 mm. Art. 10.108.72 □ 14 Art. 10.108.73 □ 16 Art. 10.108.74 □ 12 Art. 10.108.75 Ø 16 Art. 10.108.76 Ø 14 Art. 10.108.77 Ø 12	H.1200 mm. Art. 10.108.78 □ 14 Art. 10.108.79 □ 16 Art. 10.108.80 □ 12 Art. 10.108.81 Ø 16 Art. 10.108.82 Ø 14 Art. 10.108.83 Ø 12	H.1200 mm. Art. 10.113 □ 14 Art. 10.113.01 □ 16 Art. 10.113.02 □ 12 Art. 10.114 Ø 16 Art. 10.114.01 Ø 14 Art. 10.114.02 Ø 12	H.1200 mm. Art. 10.121 □ 14 Art. 10.121.01 □ 16 Art. 10.121.02 □ 12 Art. 10.122 Ø 16 Art. 10.122.01 Ø 14 Art. 10.122.02 Ø 12
H.1500 mm. Art. 10.091 □ 14 Art. 10.091.01 □ 16 Art. 10.091.02 □ 12 Art. 10.092 Ø 16 Art. 10.092.01 Ø 14 Art. 10.092.02 Ø 12	H.1500 mm. Art. 10.099 □ 14 Art. 10.099.01 □ 16 Art. 10.099.02 □ 12 Art. 10.100 Ø 16 Art. 10.100.01 Ø 14 Art. 10.100.02 Ø 12	H.1500 mm. Art. 10.107 □ 14 Art. 10.107.01 □ 16 Art. 10.107.02 □ 12 Art. 10.108 Ø 16 Art. 10.108.01 Ø 14 Art. 10.108.02 Ø 12	H.1500 mm. Art. 10.108.78 □ 14 Art. 10.108.79 □ 16 Art. 10.108.80 □ 12 Art. 10.108.81 Ø 16 Art. 10.108.82 Ø 14 Art. 10.108.83 Ø 12	H.1500 mm. Art. 10.108.78 □ 14 Art. 10.108.79 □ 16 Art. 10.108.80 □ 12 Art. 10.108.81 Ø 16 Art. 10.108.82 Ø 14 Art. 10.108.83 Ø 12	H.1500 mm. Art. 10.115 □ 14 Art. 10.115.01 □ 16 Art. 10.115.02 □ 12 Art. 10.116 Ø 16 Art. 10.116.01 Ø 14 Art. 10.116.02 Ø 12	H.1500 mm. Art. 10.123 □ 14 Art. 10.123.01 □ 16 Art. 10.123.02 □ 12 Art. 10.124 Ø 16 Art. 10.124.01 Ø 14 Art. 10.124.02 Ø 12
						
H.950 mm. Art. 10.125 □ 14 Art. 10.125.01 □ 16 Art. 10.125.02 □ 12 Art. 10.126 Ø 16 Art. 10.126.01 Ø 14 Art. 10.126.02 Ø 12	H.950 mm. Art. 10.133 □ 14 Art. 10.133.01 □ 16 Art. 10.133.02 □ 12 Art. 10.134 Ø 16 Art. 10.134.01 Ø 14 Art. 10.134.02 Ø 12	H.950 mm. Art. 10.141 □ 14 Art. 10.141.01 □ 16 Art. 10.141.02 □ 12 Art. 10.142 Ø 16 Art. 10.142.01 Ø 14 Art. 10.142.02 Ø 12	H.950 mm. Art. 10.141 □ 14 Art. 10.141.01 □ 16 Art. 10.141.02 □ 12 Art. 10.142 Ø 16 Art. 10.142.01 Ø 14 Art. 10.142.02 Ø 12	H.950 mm. Art. 10.141 □ 14 Art. 10.141.01 □ 16 Art. 10.141.02 □ 12 Art. 10.142 Ø 16 Art. 10.142.01 Ø 14 Art. 10.142.02 Ø 12		
H.1000 mm. Art. 10.127 □ 14 Art. 10.127.01 □ 16 Art. 10.127.02 □ 12 Art. 10.128 Ø 16 Art. 10.128.01 Ø 14 Art. 10.128.02 Ø 12	H.1000 mm. Art. 10.135 □ 14 Art. 10.135.01 □ 16 Art. 10.135.02 □ 12 Art. 10.136 Ø 16 Art. 10.136.01 Ø 14 Art. 10.136.02 Ø 12	H.1000 mm. Art. 10.143 □ 14 Art. 10.143.01 □ 16 Art. 10.143.02 □ 12 Art. 10.144 Ø 16 Art. 10.144.01 Ø 14 Art. 10.144.02 Ø 12	H.1000 mm. Art. 10.143 □ 14 Art. 10.143.01 □ 16 Art. 10.143.02 □ 12 Art. 10.144 Ø 16 Art. 10.144.01 Ø 14 Art. 10.144.02 Ø 12	H.1000 mm. Art. 10.143 □ 14 Art. 10.143.01 □ 16 Art. 10.143.02 □ 12 Art. 10.144 Ø 16 Art. 10.144.01 Ø 14 Art. 10.144.02 Ø 12		
H.1200 mm. Art. 10.129 □ 14 Art. 10.129.01 □ 16 Art. 10.129.02 □ 12 Art. 10.130 Ø 16 Art. 10.130.01 Ø 14 Art. 10.130.02 Ø 12	H.1200 mm. Art. 10.137 □ 14 Art. 10.137.01 □ 16 Art. 10.137.02 □ 12 Art. 10.138 Ø 16 Art. 10.138.01 Ø 14 Art. 10.138.02 Ø 12	H.1200 mm. Art. 10.145 □ 14 Art. 10.145.01 □ 16 Art. 10.145.02 □ 12 Art. 10.146 Ø 16 Art. 10.146.01 Ø 14 Art. 10.146.02 Ø 12	H.1200 mm. Art. 10.145 □ 14 Art. 10.145.01 □ 16 Art. 10.145.02 □ 12 Art. 10.146 Ø 16 Art. 10.146.01 Ø 14 Art. 10.146.02 Ø 12	H.1200 mm. Art. 10.145 □ 14 Art. 10.145.01 □ 16 Art. 10.145.02 □ 12 Art. 10.146 Ø 16 Art. 10.146.01 Ø 14 Art. 10.146.02 Ø 12		
H.1500 mm. Art. 10.131 □ 14 Art. 10.131.01 □ 16 Art. 10.131.02 □ 12 Art. 10.132 Ø 16 Art. 10.132.01 Ø 14 Art. 10.132.02 Ø 12	H.1500 mm. Art. 10.139 □ 14 Art. 10.139.01 □ 16 Art. 10.139.02 □ 12 Art. 10.140 Ø 16 Art. 10.140.01 Ø 14 Art. 10.140.02 Ø 12	H.1500 mm. Art. 10.147 □ 14 Art. 10.147.01 □ 16 Art. 10.147.02 □ 12 Art. 10.148 Ø 16 Art. 10.148.01 Ø 14 Art. 10.148.02 Ø 12	H.1500 mm. Art. 10.147 □ 14 Art. 10.147.01 □ 16 Art. 10.147.02 □ 12 Art. 10.148 Ø 16 Art. 10.148.01 Ø 14 Art. 10.148.02 Ø 12	H.1500 mm. Art. 10.147 □ 14 Art. 10.147.01 □ 16 Art. 10.147.02 □ 12 Art. 10.148 Ø 16 Art. 10.148.01 Ø 14 Art. 10.148.02 Ø 12		
					Martellato Hammered H.950 mm. Art. 10.148.03 □ 12 Art. 10.148.04 □ 14 Art. 10.148.05 □ 16	H.950 mm. Art. 10.148.50 □ 12 Art. 10.148.51 □ 14 Art. 10.148.52 □ 16
					H.1000 mm. Art. 10.148.06 □ 12 Art. 10.148.07 □ 14 Art. 10.148.08 □ 16	H.1000 mm. Art. 10.148.53 □ 12 Art. 10.148.54 □ 14 Art. 10.148.55 □ 16
					H.1200 mm. Art. 10.148.09 □ 12 Art. 10.148.10 □ 14 Art. 10.148.11 □ 16	H.1200 mm. Art. 10.148.56 □ 12 Art. 10.148.57 □ 14 Art. 10.148.58 □ 16
					H.1500 mm. Art. 10.148.12 □ 12 Art. 10.148.13 □ 14 Art. 10.148.14 □ 16	H.1500 mm. Art. 10.148.59 □ 12 Art. 10.148.60 □ 14 Art. 10.148.61 □ 16

Tutte le parti di questo catalogo - foto comprese - sono di proprietà Euro-Fer. La riproduzione, anche parziale, è vietata in ogni forma e con ogni mezzo. / Every part of this catalogue - photos included - is Euro-Fer's property. All forms of copying are strictly prohibited.

from art. 10.085 to art. 10.148.61

EUROFER 159

NEW

PALLINE PICCOLE / SMALL BALLS

H.950 mm. Art. 10.149 □14 Art. 10.149.01 □16 Art. 10.149.02 □12	H.950 mm. Art. 10.152.03 Ø 14 Art. 10.152.04 Ø 16	H.1000 mm. Art. 10.150 □14 Art. 10.150.01 □16 Art. 10.150.02 □12	H.1000 mm. Art. 10.151 □14 Art. 10.151.01 □16 Art. 10.151.02 □12	H.1500 mm. Art. 10.152 □14 Art. 10.152.01 □16 Art. 10.152.02 □12	H.1200 mm. Art. 10.152.05 Ø 14 Art. 10.152.06 Ø 16	H.1500 mm. Art. 10.152.07 Ø 14 Art. 10.152.08 Ø 16	H.1800 mm. Art. 10.152.09 Ø 14 Art. 10.152.10 Ø 16	H.1000 mm. Art. 10.152.41 □12 Art. 10.152.42 □14	H.1600 mm. Art. 10.152.55 □14	H.1700 mm. Art. 10.152.56 □14	H.1800 mm. Art. 10.152.57 □14	H.1000 mm. Art. 10.152.11 □12 Art. 10.152.12 □14 Art. 10.152.13 □16	H.1200 mm. Art. 10.152.14 □12 Art. 10.152.15 □14 Art. 10.152.16 □16	H.1500 mm. Art. 10.152.17 □12 Art. 10.152.18 □14 Art. 10.152.19 □16	H.1800 mm. Art. 10.152.20 □12 Art. 10.152.21 □14 Art. 10.152.22 □16	H.1000 mm. Art. 10.152.23 Ø 14 Art. 10.152.24 Ø 16	H.1200 mm. Art. 10.152.25 Ø 14 Art. 10.152.26 Ø 16	H.1500 mm. Art. 10.152.27 Ø 14 Art. 10.152.28 Ø 16	H.1800 mm. Art. 10.152.29 Ø 14 Art. 10.152.30 Ø 16	H.950 mm. Art. 10.153 Ø 12 Art. 10.154 Ø 14 Art. 10.155 Ø 16	H.1000 mm. Art. 10.156 Ø 12 Art. 10.157 Ø 14 Art. 10.158 Ø 16	H.1200 mm. Art. 10.159 Ø 12 Art. 10.160 Ø 14 Art. 10.161 Ø 16	H.1500 mm. Art. 10.162 Ø 12 Art. 10.163 Ø 14 Art. 10.164 Ø 16	H.950 mm. Art. 10.165 Ø 12 Art. 10.166 Ø 14 Art. 10.167 Ø 16	H.1000 mm. Art. 10.168 Ø 12 Art. 10.169 Ø 14 Art. 10.170 Ø 16	H.1200 mm. Art. 10.171 Ø 12 Art. 10.172 Ø 14 Art. 10.173 Ø 16	H.1500 mm. Art. 10.174 Ø 12 Art. 10.175 Ø 14 Art. 10.176 Ø 16	H.950 mm. Art. 10.177 Ø 12 Art. 10.178 Ø 14 Art. 10.179 Ø 16	H.1000 mm. Art. 10.180 Ø 12 Art. 10.181 Ø 14 Art. 10.182 Ø 16	H.1200 mm. Art. 10.183 Ø 12 Art. 10.184 Ø 14 Art. 10.185 Ø 16	H.1500 mm. Art. 10.186 Ø 12 Art. 10.187 Ø 14 Art. 10.188 Ø 16
--	---	---	---	---	--	--	--	--	----------------------------------	----------------------------------	----------------------------------	--	--	--	--	--	--	--	--	---	--	--	--	---	--	--	--	---	--	--	--

PALLINE PICCOLE / SMALL BALLS

H.950 mm. Art. 10.189 Ø 12 Art. 10.190 Ø 14 Art. 10.191 Ø 16	H.1000 mm. Art. 10.192 Ø 12 Art. 10.193 Ø 14 Art. 10.194 Ø 16	H.1200 mm. Art. 10.195 Ø 12 Art. 10.196 Ø 14 Art. 10.197 Ø 16	H.1500 mm. Art. 10.198 Ø 12 Art. 10.199 Ø 14 Art. 10.200 Ø 16	H.950 mm. Art. 10.201 Ø 12 Art. 10.202 Ø 14 Art. 10.203 Ø 16	H.1000 mm. Art. 10.204 Ø 12 Art. 10.205 Ø 14 Art. 10.206 Ø 16	H.1200 mm. Art. 10.207 Ø 12 Art. 10.208 Ø 14 Art. 10.209 Ø 16	H.1500 mm. Art. 10.210 Ø 12 Art. 10.211 Ø 14 Art. 10.212 Ø 16	H.950 mm. Art. 10.213 □12 Art. 10.214 □14 Art. 10.215 □16	H.1000 mm. Art. 10.216 □12 Art. 10.217 □14 Art. 10.218 □16	H.1200 mm. Art. 10.219 □12 Art. 10.220 □14 Art. 10.221 □16	H.1500 mm. Art. 10.222 □12 Art. 10.223 □14 Art. 10.224 □16	H.950 mm. Art. 10.225 □12 Art. 10.226 □14 Art. 10.227 □16	H.1000 mm. Art. 10.228 □12 Art. 10.229 □14 Art. 10.230 □16	H.1200 mm. Art. 10.231 □12 Art. 10.232 □14 Art. 10.233 □16	H.1500 mm. Art. 10.234 □12 Art. 10.235 □14 Art. 10.236 □16	H.950 mm. Art. 10.237 □12 Art. 10.238 □14 Art. 10.239 □16	H.1000 mm. Art. 10.240 □12 Art. 10.241 □14 Art. 10.242 □16	H.1200 mm. Art. 10.243 □12 Art. 10.244 □14 Art. 10.245 □16	H.1500 mm. Art. 10.246 □12 Art. 10.247 □14 Art. 10.248 □16	H.950 mm. Art. 10.249 □12 Art. 10.250 □14 Art. 10.251 □16	H.1000 mm. Art. 10.252 □12 Art. 10.253 □14 Art. 10.254 □16	H.1200 mm. Art. 10.255 □12 Art. 10.256 □14 Art. 10.257 □16	H.1500 mm. Art. 10.258 □12 Art. 10.259 □14 Art. 10.260 □16	H.950 mm. Art. 10.261 □12 Art. 10.262 □14 Art. 10.263 □16	H.1000 mm. Art. 10.264 □12 Art. 10.265 □14 Art. 10.266 □16	H.1200 mm. Art. 10.267 □12 Art. 10.268 □14 Art. 10.269 □16	H.1500 mm. Art. 10.270 □12 Art. 10.271 □14 Art. 10.272 □16
---	--	--	--	---	--	--	--	--	---	---	---	--	---	---	---	--	---	---	---	--	---	---	---	--	---	---	---

Tutte le parti di questo catalogo - foto comprese - sono di proprietà Euro-Fer. La riproduzione, anche parziale, è vietata in ogni forma e con ogni mezzo. / Every part of this catalogue - photos included - is Euro-Fer's property. All forms of copying are strictly prohibited.

PALLINE PICCOLE / SMALL BALLS



*Martellato
Hammered*
H.950 mm.
Art. 10.273 □12
Art. 10.274 □14
Art. 10.275 □16
H.1000 mm.
Art. 10.276 □12
Art. 10.277 □14
Art. 10.278 □16
H.1200 mm.
Art. 10.279 □12
Art. 10.280 □14
Art. 10.281 □16
H.1500 mm.
Art. 10.282 □12
Art. 10.283 □14
Art. 10.284 □16

*Martellato
Hammered*
H.950 mm.
Art. 10.285 □12
Art. 10.286 □14
Art. 10.287 □16
H.1000 mm.
Art. 10.288 □12
Art. 10.289 □14
Art. 10.290 □16
H.1200 mm.
Art. 10.291 □12
Art. 10.292 □14
Art. 10.293 □16
H.1500 mm.
Art. 10.294 □12
Art. 10.295 □14
Art. 10.296 □16

*Martellato
Hammered*
H.950 mm.
Art. 10.297 □12
Art. 10.298 □14
Art. 10.299 □16
H.1000 mm.
Art. 10.300 □12
Art. 10.301 □14
Art. 10.302 □16
H.1200 mm.
Art. 10.303 □12
Art. 10.304 □14
Art. 10.305 □16
H.1500 mm.
Art. 10.306 □12
Art. 10.307 □14
Art. 10.308 □16

*Martellato
Hammered*
H.950 mm.
Art. 10.309 □12
Art. 10.310 □14
Art. 10.311 □16
H.1000 mm.
Art. 10.312 □12
Art. 10.313 □14
Art. 10.314 □16
H.1200 mm.
Art. 10.315 □12
Art. 10.316 □14
Art. 10.317 □16
H.1500 mm.
Art. 10.318 □12
Art. 10.319 □14
Art. 10.320 □16

*Martellato
Hammered*
H.950 mm.
Art. 10.321 □12
Art. 10.322 □14
Art. 10.323 □16
H.1000 mm.
Art. 10.324 □12
Art. 10.325 □14
Art. 10.326 □16
H.1200 mm.
Art. 10.327 □12
Art. 10.328 □14
Art. 10.329 □16
H.1500 mm.
Art. 10.330 □12
Art. 10.331 □14
Art. 10.332 □16

Tondo / Round
H.950 mm.
Art. 10.333 Ø 12
Art. 10.334 Ø 14
Art. 10.335 Ø 16
H.1000 mm.
Art. 10.336 Ø 12
Art. 10.337 Ø 14
Art. 10.338 Ø 16
H.1200 mm.
Art. 10.339 Ø 12
Art. 10.340 Ø 14
Art. 10.341 Ø 16
H.1500 mm.
Art. 10.342 Ø 12
Art. 10.343 Ø 14
Art. 10.344 Ø 16

Tondo / Round
H.950 mm.
Art. 10.345 Ø 12
Art. 10.346 Ø 14
Art. 10.347 Ø 16
H.1000 mm.
Art. 10.348 Ø 12
Art. 10.349 Ø 14
Art. 10.350 Ø 16
H.1200 mm.
Art. 10.351 Ø 12
Art. 10.352 Ø 14
Art. 10.353 Ø 16
H.1500 mm.
Art. 10.354 Ø 12
Art. 10.355 Ø 14
Art. 10.356 Ø 16

PALLINE PICCOLE / SMALL BALLS

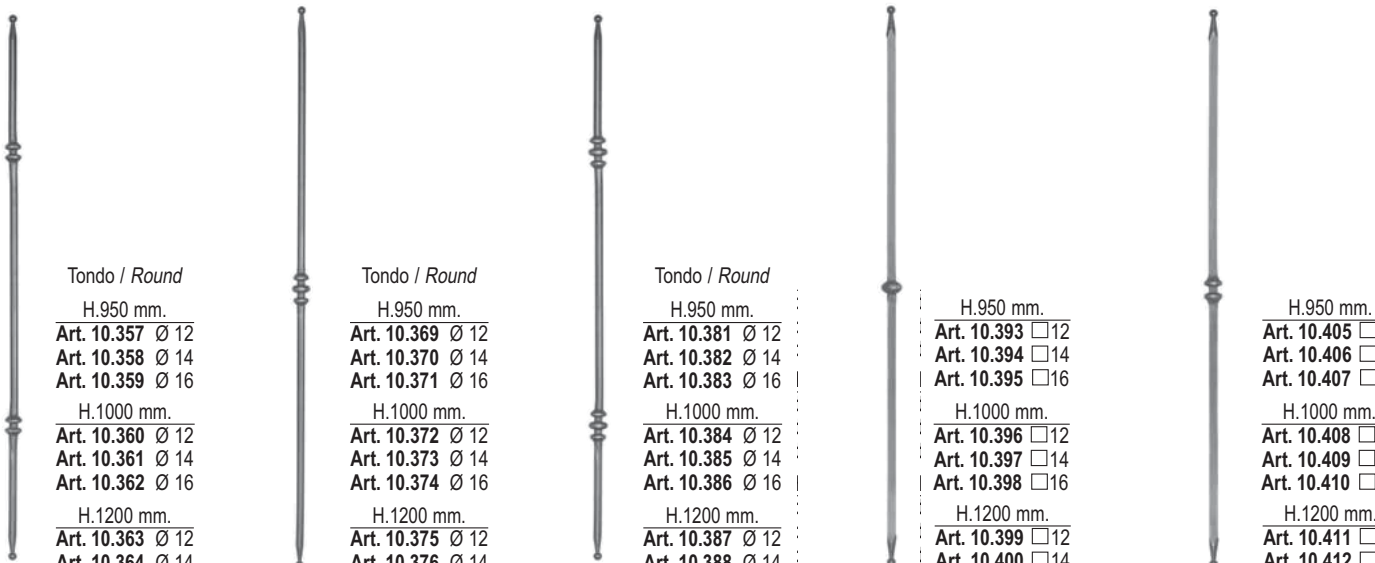

Tondo / Round
H.950 mm.
Art. 10.357 Ø 12
Art. 10.358 Ø 14
Art. 10.359 Ø 16
H.1000 mm.
Art. 10.360 Ø 12
Art. 10.361 Ø 14
Art. 10.362 Ø 16
H.1200 mm.
Art. 10.363 Ø 12
Art. 10.364 Ø 14
Art. 10.365 Ø 16
H.1500 mm.
Art. 10.366 Ø 12
Art. 10.367 Ø 14
Art. 10.368 Ø 16

Tondo / Round
H.950 mm.
Art. 10.369 Ø 12
Art. 10.370 Ø 14
Art. 10.371 Ø 16
H.1000 mm.
Art. 10.372 Ø 12
Art. 10.373 Ø 14
Art. 10.374 Ø 16
H.1200 mm.
Art. 10.375 Ø 12
Art. 10.376 Ø 14
Art. 10.377 Ø 16
H.1500 mm.
Art. 10.378 Ø 12
Art. 10.379 Ø 14
Art. 10.380 Ø 16

Tondo / Round
H.950 mm.
Art. 10.381 Ø 12
Art. 10.382 Ø 14
Art. 10.383 Ø 16
H.1000 mm.
Art. 10.384 Ø 12
Art. 10.385 Ø 14
Art. 10.386 Ø 16
H.1200 mm.
Art. 10.387 Ø 12
Art. 10.388 Ø 14
Art. 10.389 Ø 16
H.1500 mm.
Art. 10.390 Ø 12
Art. 10.391 Ø 14
Art. 10.392 Ø 16

H.950 mm.
Art. 10.393 □12
Art. 10.394 □14
Art. 10.395 □16
H.1000 mm.
Art. 10.396 □12
Art. 10.397 □14
Art. 10.398 □16
H.1200 mm.
Art. 10.399 □12
Art. 10.400 □14
Art. 10.401 □16
H.1500 mm.
Art. 10.402 □12
Art. 10.403 □14
Art. 10.404 □16

H.950 mm.
Art. 10.405 □12
Art. 10.406 □14
Art. 10.407 □16
H.1000 mm.
Art. 10.408 □12
Art. 10.409 □14
Art. 10.410 □16
H.1200 mm.
Art. 10.411 □12
Art. 10.412 □14
Art. 10.413 □16
H.1500 mm.
Art. 10.414 □12
Art. 10.415 □14
Art. 10.416 □16

Tutte le parti di questo catalogo - foto comprese - sono di proprietà Euro-Fer. La riproduzione, anche parziale, è vietata in ogni forma e con ogni mezzo. / Every part of this catalogue - photos included - is Euro-Fer's property. All forms of copying are strictly prohibited.

PALLINE PICCOLE / SMALL BALLS



H.950 mm.
Art. 10.417 12
Art. 10.418 14
Art. 10.419 16

H.950 mm.
Art. 10.429 12
Art. 10.430 14
Art. 10.431 16

H.950 mm.
Art. 10.441 12
Art. 10.442 14
Art. 10.443 16

Martellato
Hammered
H.950 mm.
Art. 10.453 12
Art. 10.454 14
Art. 10.455 16

Martellato
Hammered
H.950 mm.
Art. 10.465 12
Art. 10.466 14
Art. 10.467 16

Martellato
Hammered
H.950 mm.
Art. 10.477 12
Art. 10.478 14
Art. 10.479 16

Martellato
Hammered
H.950 mm.
Art. 10.489 12
Art. 10.490 14
Art. 10.491 16

H.1000 mm.
Art. 10.420 12
Art. 10.421 14
Art. 10.422 16

H.1000 mm.
Art. 10.432 12
Art. 10.433 14
Art. 10.434 16

H.1000 mm.
Art. 10.444 12
Art. 10.445 14
Art. 10.446 16

H.1000 mm.
Art. 10.456 12
Art. 10.457 14
Art. 10.458 16

H.1000 mm.
Art. 10.468 12
Art. 10.469 14
Art. 10.470 16

H.1000 mm.
Art. 10.480 12
Art. 10.481 14
Art. 10.482 16

H.1000 mm.
Art. 10.492 12
Art. 10.493 14
Art. 10.494 16

H.1200 mm.
Art. 10.423 12
Art. 10.424 14
Art. 10.425 16

H.1200 mm.
Art. 10.435 12
Art. 10.436 14
Art. 10.437 16

H.1200 mm.
Art. 10.447 12
Art. 10.448 14
Art. 10.449 16

H.1200 mm.
Art. 10.459 12
Art. 10.460 14
Art. 10.461 16

H.1200 mm.
Art. 10.471 12
Art. 10.472 14
Art. 10.473 16

H.1200 mm.
Art. 10.483 12
Art. 10.484 14
Art. 10.485 16

H.1200 mm.
Art. 10.495 12
Art. 10.496 14
Art. 10.497 16

H.1500 mm.
Art. 10.426 12
Art. 10.427 14
Art. 10.428 16

H.1500 mm.
Art. 10.438 12
Art. 10.439 14
Art. 10.440 16

H.1500 mm.
Art. 10.450 12
Art. 10.451 14
Art. 10.452 16

H.1500 mm.
Art. 10.462 12
Art. 10.463 14
Art. 10.464 16

H.1500 mm.
Art. 10.474 12
Art. 10.475 14
Art. 10.476 16

H.1500 mm.
Art. 10.486 12
Art. 10.487 14
Art. 10.488 16

H.1500 mm.
Art. 10.498 12
Art. 10.499 14
Art. 10.500 16

PALLINE PICCOLE / SMALL BALLS



Martellato
Hammered

H.950 mm.
Art. 10.501 12
Art. 10.502 14
Art. 10.503 16

H.1000 mm.
Art. 10.504 12
Art. 10.505 14
Art. 10.506 16

H.1200 mm.
Art. 10.507 12
Art. 10.508 14
Art. 10.509 16

H.1500 mm.
Art. 10.510 12
Art. 10.511 14
Art. 10.512 16

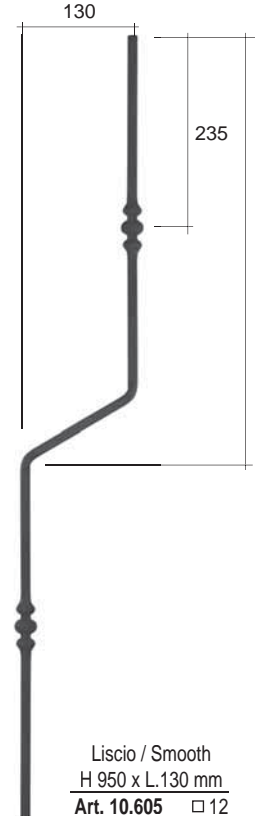

Nuovi ricalcati corteccia e rigati martellati / New forged bars bark model and fluted hammered



Corteccia / Bark model
H.950 mm

- Art. 10.001.CO Ø 16
 - Art. 10.001.01.CO Ø 14
 - Art. 10.001.02.CO Ø 12
 - Art. 10.013.CO □ 14
 - Art. 10.013.01.CO □ 16
 - Art. 10.013.02.CO □ 12
- H.1000 mm
- Art. 10.002.CO Ø 16
 - Art. 10.002.01.CO Ø 14
 - Art. 10.002.02.CO Ø 12
 - Art. 10.014.CO □ 14
 - Art. 10.014.01.CO □ 16
 - Art. 10.014.02.CO □ 12

Corteccia / Bark model
H.950 mm

- Art. 10.040.15.CO □ 12
 - Art. 10.040.16.CO □ 14
 - Art. 10.040.17.CO □ 16
- H.1000 mm
- Art. 10.040.18.CO □ 12
 - Art. 10.040.19.CO □ 14
 - Art. 10.040.20.CO □ 16
- Rigato Martellato /
Fluted Hammered
H.950 mm
- Art. 10.040.15.RM □ 12
 - Art. 10.040.16.RM □ 14
 - Art. 10.040.17.RM □ 16

Corteccia / Bark model
H.950 mm

- Art. 10.005.CO Ø 16
 - Art. 10.005.01.CO Ø 14
 - Art. 10.005.02.CO Ø 12
 - Art. 10.017.CO □ 14
 - Art. 10.017.01.CO □ 16
 - Art. 10.017.02.CO □ 12
- H.1000 mm
- Art. 10.006.CO Ø 16
 - Art. 10.006.01.CO Ø 14
 - Art. 10.006.02.CO Ø 12
 - Art. 10.018.CO □ 14
 - Art. 10.018.01.CO □ 16
 - Art. 10.018.02.CO □ 12

Corteccia / Bark model
H.950 mm

- Art. 10.009.CO Ø 16
 - Art. 10.009.01.CO Ø 14
 - Art. 10.009.02.CO Ø 12
 - Art. 10.021.CO □ 14
 - Art. 10.021.01.CO □ 16
 - Art. 10.021.02.CO □ 12
- H.1000 mm
- Art. 10.010.CO Ø 16
 - Art. 10.010.01.CO Ø 14
 - Art. 10.010.02.CO Ø 12
 - Art. 10.022.CO □ 14
 - Art. 10.022.01.CO □ 16
 - Art. 10.022.02.CO □ 12

Corteccia / Bark model
H.950 mm

- Art. 10.026.CO Ø 16
 - Art. 10.026.01.CO Ø 14
 - Art. 10.026.02.CO Ø 12
 - Art. 10.025.CO □ 14
 - Art. 10.025.01.CO □ 16
 - Art. 10.025.02.CO □ 12
- H.1000 mm
- Art. 10.028.CO Ø 16
 - Art. 10.028.01.CO Ø 14
 - Art. 10.028.02.CO Ø 12
 - Art. 10.027.CO □ 14
 - Art. 10.027.01.CO □ 16
 - Art. 10.027.02.CO □ 12

Corteccia / Bark model
H.950 mm

- Art. 10.034.CO Ø 16
 - Art. 10.034.01.CO Ø 14
 - Art. 10.034.02.CO Ø 12
 - Art. 10.033.CO □ 14
 - Art. 10.033.01.CO □ 16
 - Art. 10.033.02.CO □ 12
- H.1000 mm
- Art. 10.036.CO Ø 16
 - Art. 10.036.01.CO Ø 14
 - Art. 10.036.02.CO Ø 12
 - Art. 10.035.CO □ 14
 - Art. 10.035.01.CO □ 16
 - Art. 10.035.02.CO □ 12

Rigato Martellato /
Fluted Hammered
H.950 mm

- Art. 10.013.RM □ 14
- Art. 10.013.01.RM □ 16
- Art. 10.013.02.RM □ 12

Rigato Martellato /
Fluted Hammered
H.950 mm

- Art. 10.017.RM □ 14
- Art. 10.017.01.RM □ 16
- Art. 10.017.02.RM □ 12

Rigato Martellato /
Fluted Hammered
H.950 mm

- Art. 10.021.RM □ 14
- Art. 10.021.01.RM □ 16
- Art. 10.021.02.RM □ 12

Rigato Martellato /
Fluted Hammered
H.950 mm

- Art. 10.025.RM □ 14
- Art. 10.025.01.RM □ 16
- Art. 10.025.02.RM □ 12

Rigato Martellato /
Fluted Hammered
H.950 mm

- Art. 10.033.RM □ 14
- Art. 10.033.01.RM □ 16
- Art. 10.033.02.RM □ 12

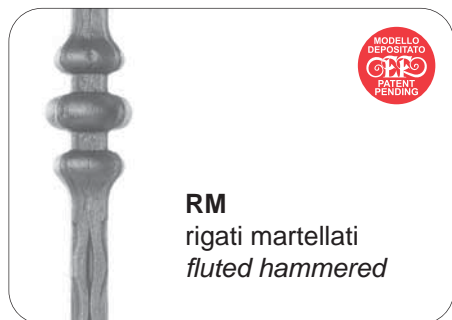

RM
rigati martellati
fluted hammered



CO
corteccia
bark model



CO
corteccia
bark model



CO
corteccia
bark model



CO
corteccia
bark model



CO
corteccia
bark model

Tutte le parti di questo catalogo - foto comprese - sono di proprietà Euro-Fer. La riproduzione, anche parziale, è vietata in ogni forma e con ogni mezzo. / Every part of this catalogue - photos included - is Euro-Fer's property. All forms of copying are strictly prohibited.

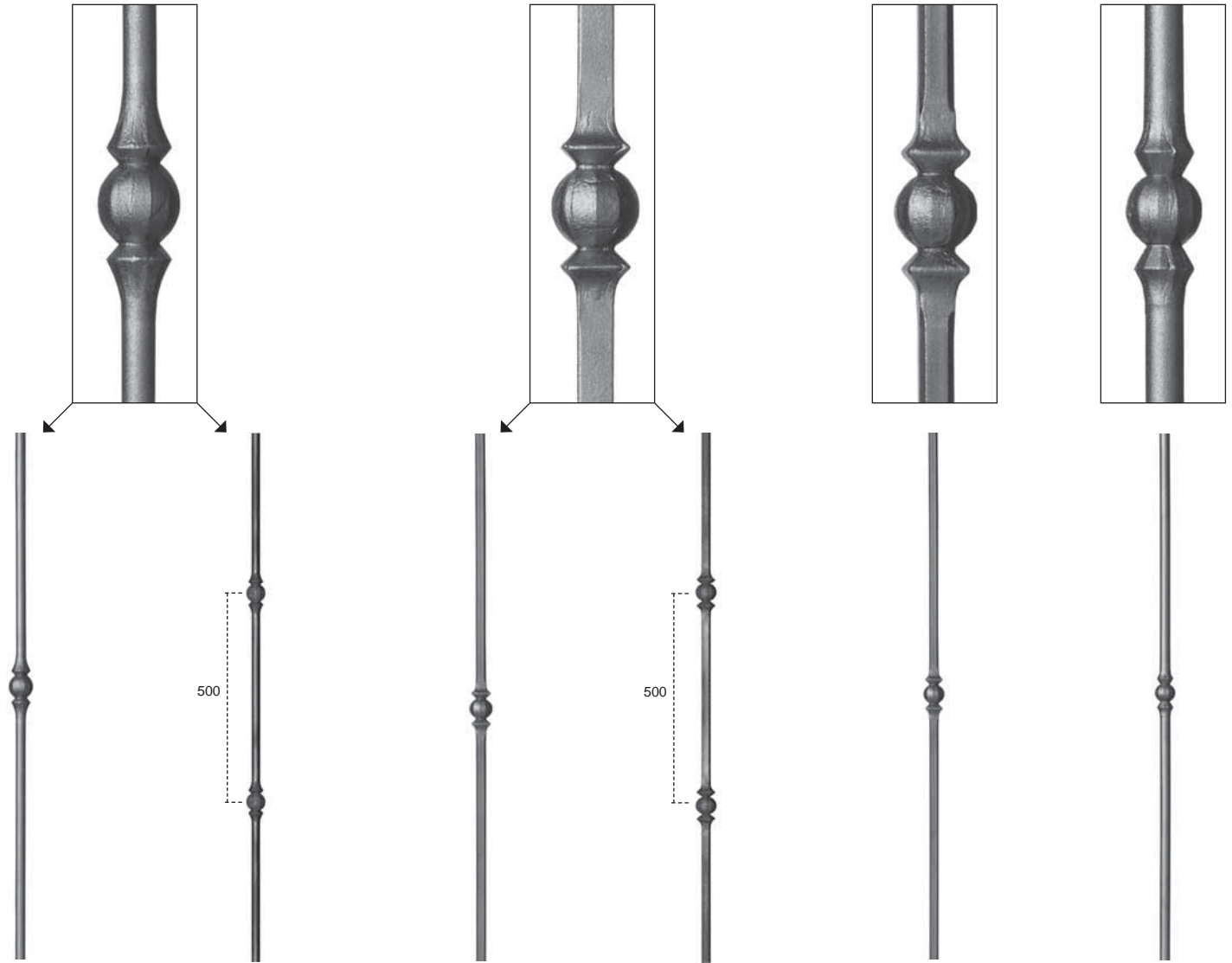

Art.11001L.T12.950
Art.11001L.T12.1000
Art.11001L.T12.1200
Art.11001L.T12.1500

Art.11001L.T14.950
Art.11001L.T14.1000
Art.11001L.T14.1200
Art.11001L.T14.1500

Art.11001L.T16.950
Art.11001L.T16.1000
Art.11001L.T16.1200
Art.11001L.T16.1500

Art.11001.01L.T12.1000
Art.11001.01L.T14.1000
Art.11001.01L.T16.1000

Art.11002L.Q12.950
Art.11002F.Q12.950
Art.11002M.Q12.950

Art.11002L.Q12.1000
Art.11002F.Q12.1000
Art.11002M.Q12.1000

Art.11002L.Q12.1200
Art.11002F.Q12.1200
Art.11002M.Q12.1200

Art.11002L.Q12.1500
Art.11002F.Q12.1500
Art.11002M.Q12.1500

Art.11002L.Q14.950
Art.11002F.Q14.950
Art.11002M.Q14.950

Art.11002L.Q14.1000
Art.11002F.Q14.1000
Art.11002M.Q14.1000

Art.11002L.Q14.1200
Art.11002F.Q14.1200
Art.11002M.Q14.1200

Art.11002L.Q14.1500
Art.11002F.Q14.1500
Art.11002M.Q14.1500

Art.11002L.Q16.950
Art.11002L.Q16.1000
Art.11002L.Q16.1200
Art.11002L.Q16.1500

Art.11003L.Q12.1000
Art.11003F.Q12.1000

Art.11003L.Q14.1000
Art.11003F.Q14.1000

Art.11003L.Q16.1000

Art.11002S.Q12.950
Art.11002S.Q12.1000
Art.11002S.Q12.1200
Art.11002S.Q12.1500

Art.11003.01L.T12.950
Art.11003.01F.T12.950

Art.11003.01L.T12.1000
Art.11003.01F.T12.1000

Art.11003.01L.T12.1200
Art.11003.01F.T12.1200

Art.11003.01L.T12.1500
Art.11003.01F.T12.1500

Art.11003.01L.T14.950
Art.11003.01L.T14.1000
Art.11003.01L.T14.1200
Art.11003.01L.T14.1500

Legenda / Legend

- Q** QUADRO / SQUARE IRON
- T** TONDO / ROUND IRON
- F** FORGIATO / FORGED
- L** LISCIO / SMOOTH
- M** MARTELLATO / HAMMERED
- S** SMUSSATO / BLUNTED

Le misure sono in millimetri
sizes are in mm

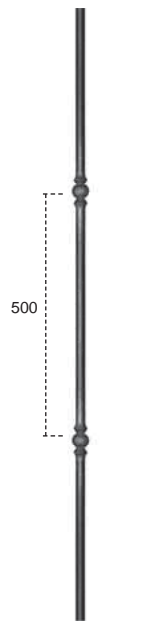

Art.11003.02L.T12.1000
Art.11003.02F.T12.1000

Art. 11004L.Q12.1000
Art. 11004L.Q12.1200
Art. 11004F.Q12.1000
Art. 11004F.Q12.1200

Art.11008L.Q12.950
Art.11008F.Q12.950
Art.11008M.Q12.950

Art.11008L.Q12.1000
Art.11008F.Q12.1000
Art.11008M.Q12.1000

Art.11008L.Q12.1200
Art.11008F.Q12.1200
Art.11008M.Q12.1200

Art.11008L.Q12.1500
Art.11008F.Q12.1500
Art.11008M.Q12.1500

Art.11008L.Q14.950
Art.11008F.Q14.950
Art.11008M.Q14.950
Art.11008L.Q14.1000
Art.11008F.Q14.1000
Art.11008M.Q14.1000

Art.11008L.Q14.1200
Art.11008F.Q14.1200
Art.11008M.Q14.1200
Art.11008L.Q14.1500
Art.11008F.Q14.1500
Art.11008M.Q14.1500

Art.11008.01L.Q12.1000
Art.11008.01F.Q12.1000
Art.11008.01M.Q12.1000

Art.11008.01L.Q14.1000
Art.11008.01F.Q14.1000
Art.11008.01M.Q14.1000

Art.11008S.Q12.950
Art.11008S.Q12.1000
Art.11008S.Q12.1200
Art.11008S.Q12.1500

Art.11008.04L.T12.950
Art.11008.04L.T12.1000
Art.11008.04L.T12.1200
Art.11008.04L.T12.1500

Art.11008.04L.T14.950
Art.11008.04L.T14.1000
Art.11008.04L.T14.1200
Art.11008.04L.T14.1500

Legenda / Legend

- Q** QUADRO / SQUARE IRON
- T** TONDO / ROUND IRON
- F** FORGIATO / FORGED
- L** LISCIO / SMOOTH
- M** MARTELLATO / HAMMERED
- S** SMUSSATO / BLUNTED

Le misure sono in millimetri
sizes are in mm

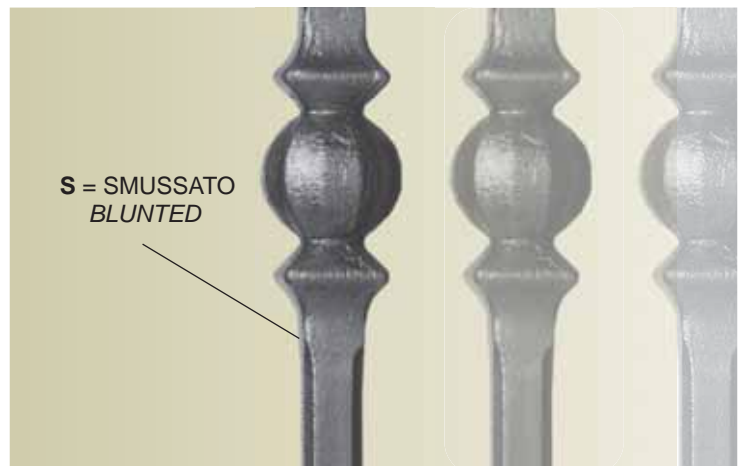

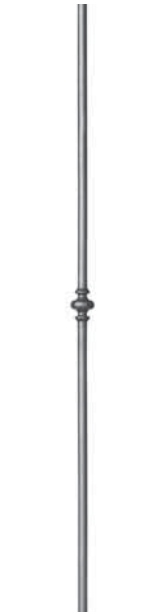

Art. 11014.10L.T12.1000
Art. 11014.10L.T12.1200
Art. 11014.10F.T12.1000
Art. 11014.10F.T12.1200

Art.11017.03L.T12.950
Art.11017.03F.T12.950

Art.11017.03L.T12.1000
Art.11017.03F.T12.1000

Art.11017.01L.T12.950
Art.11017.01F.T12.950

Art.11017.01L.T12.1000
Art.11017.01F.T12.1000

Art.11023.04L.T.12.950
Art.11023.04L.T12.1000
Art.11023.04L.T12.1200
Art.11023.04L.T12.1500

Art. 11041.36L.T12.1000
Art. 11041.36L.T12.1200
Art. 11041.36F.T12.1000
Art. 11041.36F.T12.1200

Art.11017.03L.T12.1200
Art.11017.03F.T12.1200

Art.11017.01L.T12.1200
Art.11017.01F.T12.1200

Art.11017.03L.T12.1500
Art.11017.03F.T12.1500

Art.11017.01L.T12.1500
Art.11017.01F.T12.1500

Art.11017.05L.T14.950
Art.11017.05L.T14.1000
Art.11017.05L.T14.1200
Art.11017.05L.T14.1500

Art.11017.01L.T14.950
Art.11017.01F.T14.950

Art.11017.01L.T14.1000
Art.11017.01F.T14.1000

Art.11017.01L.T14.1200
Art.11017.01F.T14.1200

Art.11017.01L.T14.1500
Art.11017.01F.T14.1500

Legenda Legend

- Q** QUADRO / SQUARE IRON
T TONDO / ROUND IRON
F FORGIATO / FORGED
L LISCIO / SMOOTH
M MARTELLATO / HAMMERED
S SMUSSATO / BLUNTED

Le misure sono in millimetri
sizes are in mm



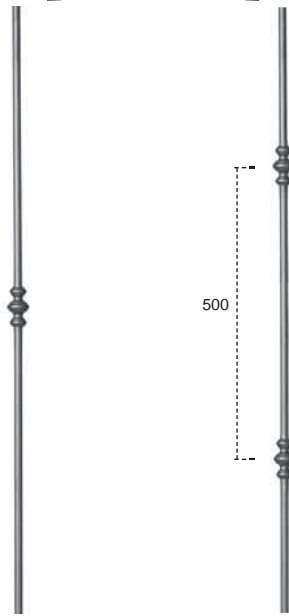
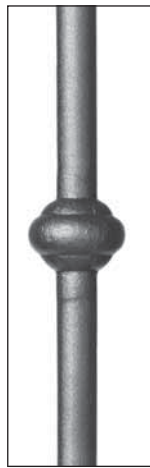

Art.11041.54L.Q12.950
Art.11041.54L.T12.950

Art.11041.55L.Q12.1000
Art.11041.55L.T12.1000

Art.11041.58L.T12.950
Art.11041.58L.Q12.950

Art.11041.60L.Q12.950
Art.11041.60L.Q12.1000

Art.11041.68L.T12.950
Art.11041.68L.T12.1000

Art.11041.70L.Q14.950
Art.11041.70L.Q14.1000
Art.11041.70L.Q14.1200
Art.11041.70L.Q14.1500

Art.11041.54L.Q12.1000
Art.11041.54L.T12.1000

Art.11041.55L.Q14.1000
Art.11041.55L.T14.1000

Art.11041.58L.T12.1000
Art.11041.58L.Q12.1000

Art.11041.54L.Q12.1200
Art.11041.54L.T12.1200

Art.11041.58L.T12.1200
Art.11041.58L.Q12.1200

Art.11041.54L.Q12.1500
Art.11041.54L.T12.1500

Art.11041.58L.T12.1500
Art.11041.58L.Q12.1500

Art.11041.54L.Q14.950
Art.11041.54L.T14.950

Art.11041.58L.T14.1000
Art.11041.58L.Q14.1000







Art.11041.54L.Q14.1000
Art.11041.54L.T14.1000

Art.11041.54L.Q14.1200
Art.11041.54L.T14.1200

Art.11041.54L.Q14.1500
Art.11041.54L.T14.1500

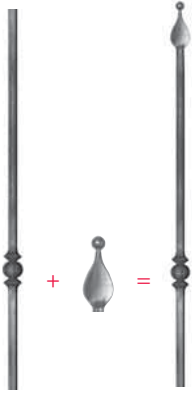
SU RICHIESTA / ON REQUEST

Tutti gli articoli di questo catalogo possono essere realizzati con queste lance / All articles in this catalogue can be realized with these spears.

	P PALLINA PICCOLA SMALL BALL		PP PUNTA A PIRAMIDE PYRAMIDAL END	 <p>Per ordinare i paletti seguire l'esempio To order bars please follow the example:</p>
	A FIAMMA FLAME		CT CODA DI TOPO TAIL END	
	AP FIAMMA E PALLINA GRANDE FLAME AND BIG BALL	$11002L.Q12.950 + AP = 11002L.Q12.950AP$		

Tutte le parti di questo catalogo - foto comprese - sono di proprietà Euro-Fer. La riproduzione, anche parziale, è vietata in ogni forma e con ogni mezzo. / Every part of this catalogue - photos included - is Euro-Fer's property. All forms of copying are strictly prohibited.

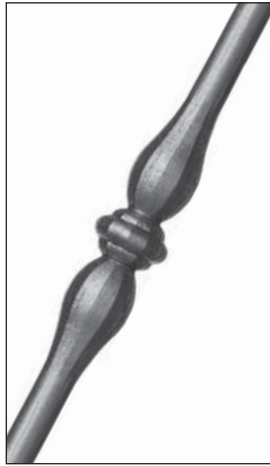

SU RICHIESTA / ON REQUEST

Tutti gli articoli di questo catalogo possono essere realizzati con queste lance / All articles in this catalogue can be realized with these spears.



P = PALLINA PICCOLA / SMALL BALL



A = FIAMMA/FLAME



AP = FIAMMA E PALLINA GRANDE / FLAME AND BIG BALL



PP = PUNTA A PIRAMIDE / PYRAMIDAL END



CT = CODA DI TOPO / TAIL END

Per ordinare i paletti seguire l'esempio / To order bars please follow the example:

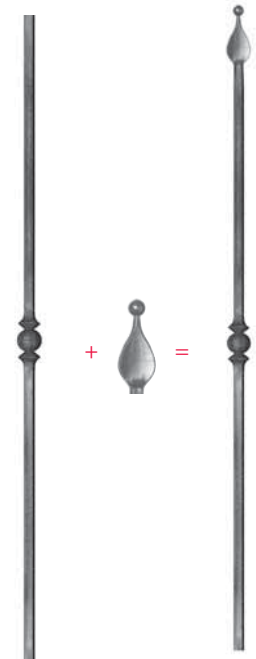

11002L.Q12.950 + AP = 11002L.Q12.950AP



Art.11098.02L.Q14.950
Art.11098.02L.Q14.1200
Art.11098.02L.Q14.1500
Art.11098.02L.Q14.1800



Art.11098.04L.T12.950
Art.11098.04L.T12.1200
Art.11098.04L.T12.1500
Art.11098.04L.T12.1800



Art.11090.01L.Q12.1000
Art.11090.01L.Q12.1200
Art.11090.01L.Q12.1500
Art.11090.01L.Q12.1800



Art.11091.01L.T12.1000
Art.11091.01L.T12.1200
Art.11091.01L.T12.1500
Art.11091.01L.T12.1800

Legenda / Legend

- Q** QUADRO / SQUARE IRON
- T** TONDO / ROUND IRON
- F** FORGIATO / FORGED
- L** LISCIO / SMOOTH
- M** MARTELLATO / HAMMERED
- S** SMUSSATO / BLUNTED

Le misure sono in millimetri
sizes are in mm



I forgiati italiani

Il Forgiato Italiano, la ricerca della qualità assoluta.
EUROFER evolve il classico paletto forgiato standard e crea il FORGIATO ITALIANO.
Con il FORGIATO ITALIANO puoi scegliere la misura, la texture, il decoro.
È fatto interamente in Italia e ti consente di inserire il motivo in ferro forgiato su un paletto liscio, martellato o smussato.

Forged bars made in Italy

The ITALIAN FORGED BARS: the pursuit of absolute quality.
EUROFER evolves the classic standard forged bollard and creates the ITALIAN FORGED BAR. With the ITALIAN FORGED BAR you can choose the size, the texture, the decor and the tip. It's made entirely in Italy and allows you to insert the forged iron motif on a smooth, hammered or beveled stake.



Art. 11002P.Q12.950
Art. 11002P.Q12.1000
Art. 11002P.Q12.1200
Art. 11002P.Q12.1500
Art. 11002P.Q12.3000
Art. 11002P.Q12.6000



Art. 11002P.Q14.950
Art. 11002P.Q14.1000
Art. 11002P.Q14.1200
Art. 11002P.Q14.1500
Art. 11002P.Q14.3000
Art. 11002P.Q14.6000



Art. 11017.01P.T12.950
Art. 11017.01P.T12.1000
Art. 11017.01P.T12.1200
Art. 11017.01P.T12.1500
Art. 11017.01P.T12.3000
Art. 11017.01P.T12.6000



Art. 11017.01P.T14.950
Art. 11017.01P.T14.1000
Art. 11017.01P.T14.1200
Art. 11017.01P.T14.1500
Art. 11017.01P.T14.3000
Art. 11017.01P.T14.6000

ELEMENTI IN FERRO FORGIATO E CAPISALDI
FORGED BARS AND POSTS

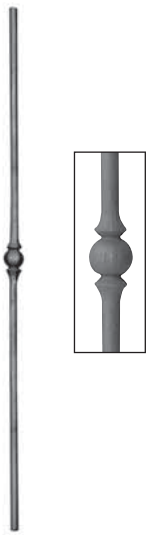

H.1000 mm.
Art. 11.001
Ø 14 circa



H.1000 mm.
Art. 11.001.01
Ø 14 circa

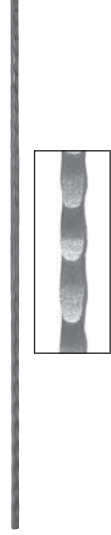

H.1000mm.
Art. 11.002.P □ 14 ca.
Art. 11.002.D.P □ 12 ca.



H.1000 mm.
Art. 11.002 □ 14 circa
Art. 11.002.E □ 10 circa
Art. 11.002.D □ 12 circa



H.1000 mm.
Art. 11.003 □ 14 circa
Art. 11.003.E □ 10 circa
Art. 11.003.D □ 12 circa



Rastrematō / Tapered
H.1000 mm.
Art. 11.003.01.P
Ø 14 circa



H.1000 mm.
Art. 11.003.01
Ø 14 circa
Art. 11.003.01.E
Ø 12 circa



H.1000 mm.
Art. 11.003.02
Ø 14 circa
Art. 11.003.02.E
Ø 12 circa

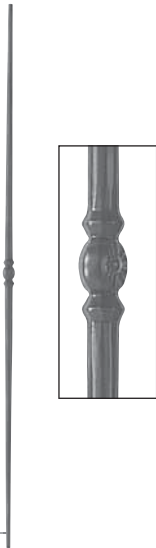

H.1000 mm.
Art. 11.003.03
Ø 14 circa

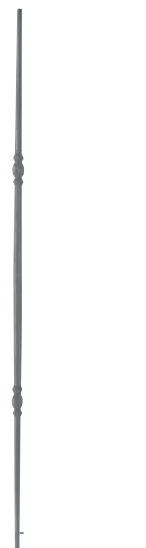

H.1000 mm.
Art. 11.003.04
Ø 14 circa

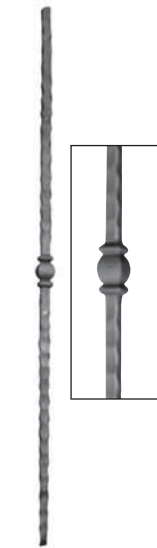

H.1000 mm.
Art. 11.004
□ 14 circa

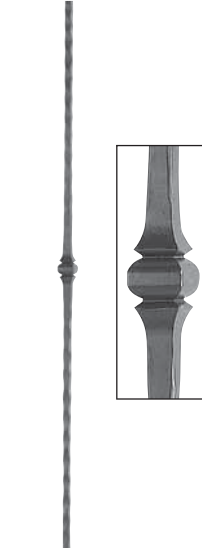

H.1000 mm.
Art. 11.004.01
□ 14 circa

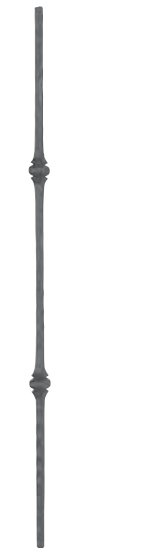

H.1000 mm.
Art. 11.004.02
□ 14 circa

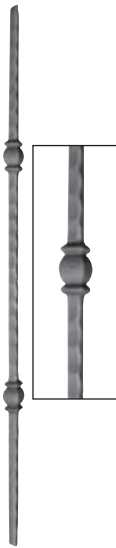

H.1000 mm.
Art. 11.005
□ 14 circa

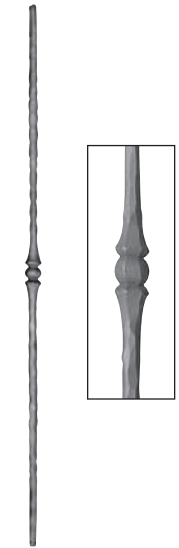

H.1000 mm.
Art. 11.006
□ 14 circa
Art. 11.006.01
Ø 14 circa



H.1000 mm.
Art. 11.007
□ 14 circa
Art. 11.007.01
Ø 14 circa



H.1000 mm.
Art. 11.008
□ 14 circa



H.1000 mm.
Art. 11.008.01
□ 14 circa



H.1000 mm.
Art. 11.008.02
Ø 14 circa



H.1000 mm.
Art. 11.008.03
Ø 14 circa



H.1000 mm.
Art. 11.008.04
Ø 12 circa



H.1000 mm.
Art. 11.008.05
Ø 12 circa

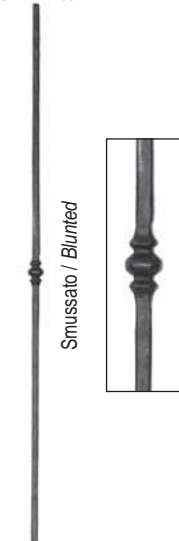

H.1000 mm.
Art. 11.008.06
□ 12 circa



H.1000 mm.
Art. 11.008.07
□ 12 circa

Smussato / Blunted

Smussato / Blunted

Tutte le parti di questo catalogo - foto comprese - sono di proprietà Euro-Fer. La riproduzione, anche parziale, è vietata in ogni forma e con ogni mezzo. / Every part of this catalogue - photos included - is Euro-Fer's property. All forms of copying are strictly prohibited.

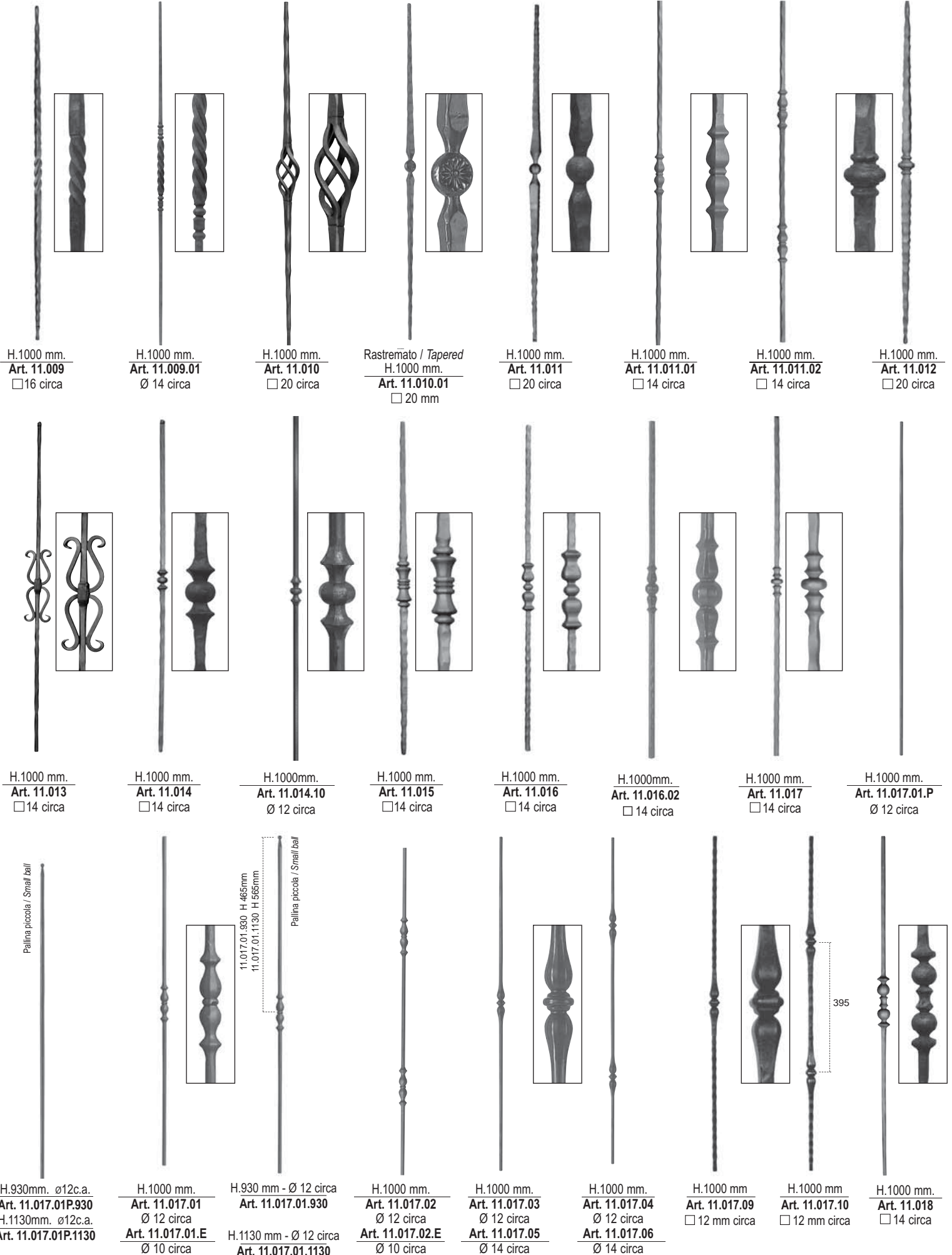

H.1000 mm. Art. 11.009 □ 16 circa
 H.1000 mm. Art. 11.009.01 □ 14 circa
 H.1000 mm. Art. 11.010 □ 20 circa
 Rastremato / Tapered H.1000 mm. Art. 11.010.01 □ 20 mm
 H.1000 mm. Art. 11.011 □ 20 circa
 H.1000 mm. Art. 11.011.01 □ 14 circa
 H.1000 mm. Art. 11.011.02 □ 14 circa
 H.1000 mm. Art. 11.012 □ 20 circa

H.1000 mm. Art. 11.013 □ 14 circa
 H.1000 mm. Art. 11.014 □ 14 circa
 H.1000mm. Art. 11.014.10 □ 12 circa
 H.1000 mm. Art. 11.015 □ 14 circa
 H.1000 mm. Art. 11.016 □ 14 circa
 H.1000mm. Art. 11.016.02 □ 14 circa
 H.1000 mm. Art. 11.017 □ 14 circa
 H.1000 mm. Art. 11.017.01.P □ 12 circa

H.930mm. ø12c.a. Art. 11.017.01P.930
 H.1130mm. ø12c.a. Art. 11.017.01P.1130
 H.1000 mm. Art. 11.017.01 □ 12 circa
 H.1000 mm. Art. 11.017.01.E □ 10 circa
 H.930 mm - Ø 12 circa Art. 11.017.01.930
 H.1130 mm - Ø 12 circa Art. 11.017.01.1130
 H.1000 mm. Art. 11.017.02 □ 12 circa
 H.1000 mm. Art. 11.017.02.E □ 10 circa
 H.1000 mm. Art. 11.017.03 □ 12 circa
 H.1000 mm. Art. 11.017.05 □ 14 circa
 H.1000 mm. Art. 11.017.04 □ 12 circa
 H.1000 mm. Art. 11.017.06 □ 14 circa
 H.1000 mm Art. 11.017.09 □ 12 mm circa
 H.1000 mm Art. 11.017.10 □ 12 mm circa
 H.1000 mm. Art. 11.018 □ 14 circa

ELEMENTI IN FERRO FORGIATO E CAPISALDI
FORGED BARS AND POSTS

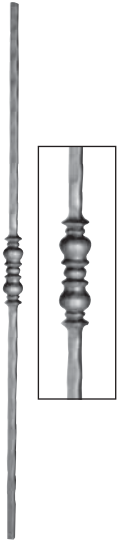

H.1000 mm.
Art. 11.019
□ 14 circa



H.1000 mm.
Art. 11.019.01
Ø 14 mm

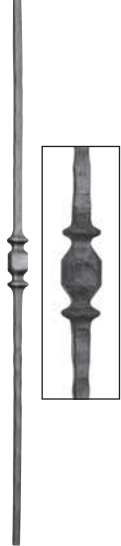

H.1000 mm.
Art. 11.020
□ 14 circa



H.1000 mm.
Art. 11.021
□ 14 circa



H.1000 mm.
Art. 11.021.01
□ 14 circa



H.1000 mm.
Art. 11.022
□ 14 circa

*Fuori Produzione
Out of Production*



H.1000 mm.
Art. 11.023.01
□ 20 circa

*Fuori Produzione
Out of Production*



Art. 11.023.02

*Fuori Produzione
Out of Production*



Art. 11.023.03



H.1000 mm.
Art. 11.023.04
Ø 14 mm



H.1000 mm.
Art. 11.023.05
Ø 14 mm



H.1000 mm.
Art. 11.024
□ 14 circa



H.1000 mm.
Art. 11.025
□ 14 circa



H.1000 mm.
Art. 11.026



H.1000 mm.
Art. 11.027



H.1000 mm.
Art. 11.028



H.1000 mm.
Art. 11.029
□ 14 circa



H.1000 mm.
Art. 11.030
□ 14 circa



H.1000 mm.
Art. 11.031
□ 14 circa



H.1000 mm.
Art. 11.032
□ 14 circa



H.1000 mm.
Art. 11.033
□ 14 circa



H.1000 mm.
Art. 11.034
□ 14 circa



H.1000 mm.
Art. 11.035
□ 14 circa

Tutte le parti di questo catalogo - foto comprese - sono di proprietà Euro-Fer. La riproduzione, anche parziale, è vietata in ogni forma e con ogni mezzo. / Every part of this catalogue - photos included - is Euro-Fer's property. All forms of copying are strictly prohibited.

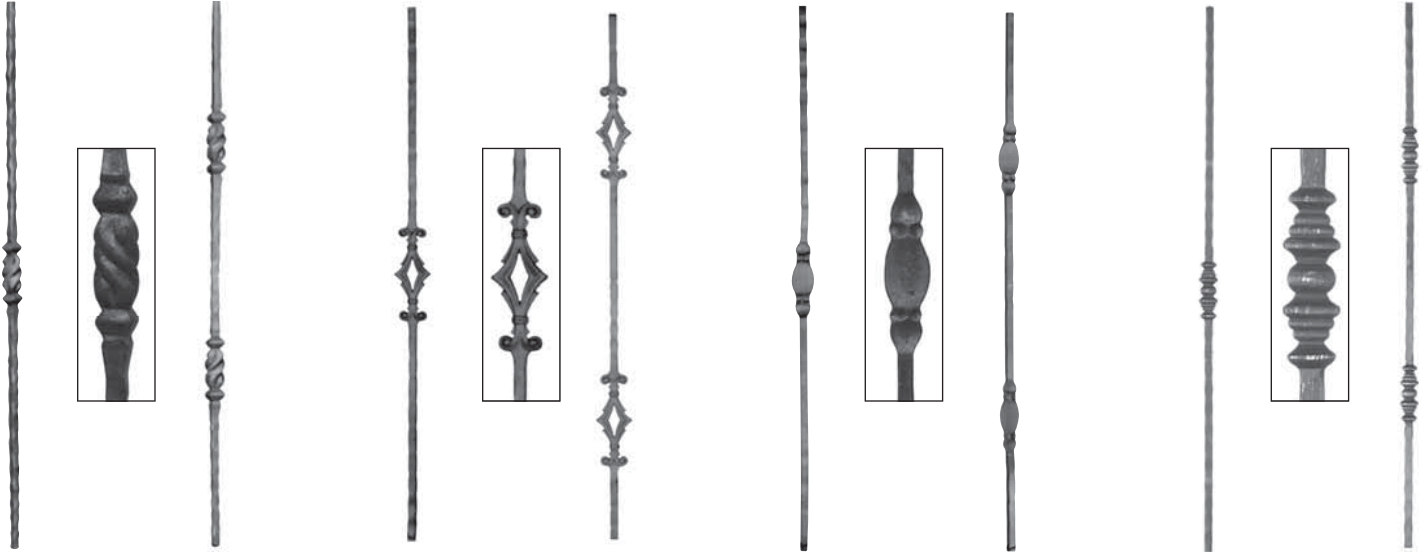

H.1000 mm. Art. 11.036 □ 14 circa
 H.1000 mm. Art. 11.037 □ 14 circa
 H.1000 mm. Art. 11.038 □ 14 circa
 H.1000 mm. Art. 11.039 □ 14 circa
 H.1000 mm. Art. 11.040 □ 12 circa
 H.1000 mm. Art. 11.041 □ 12 circa
 H.1000 mm. Art. 11.041.02 □ 14 circa
 H.1000 mm. Art. 11.041.03 □ 14 circa

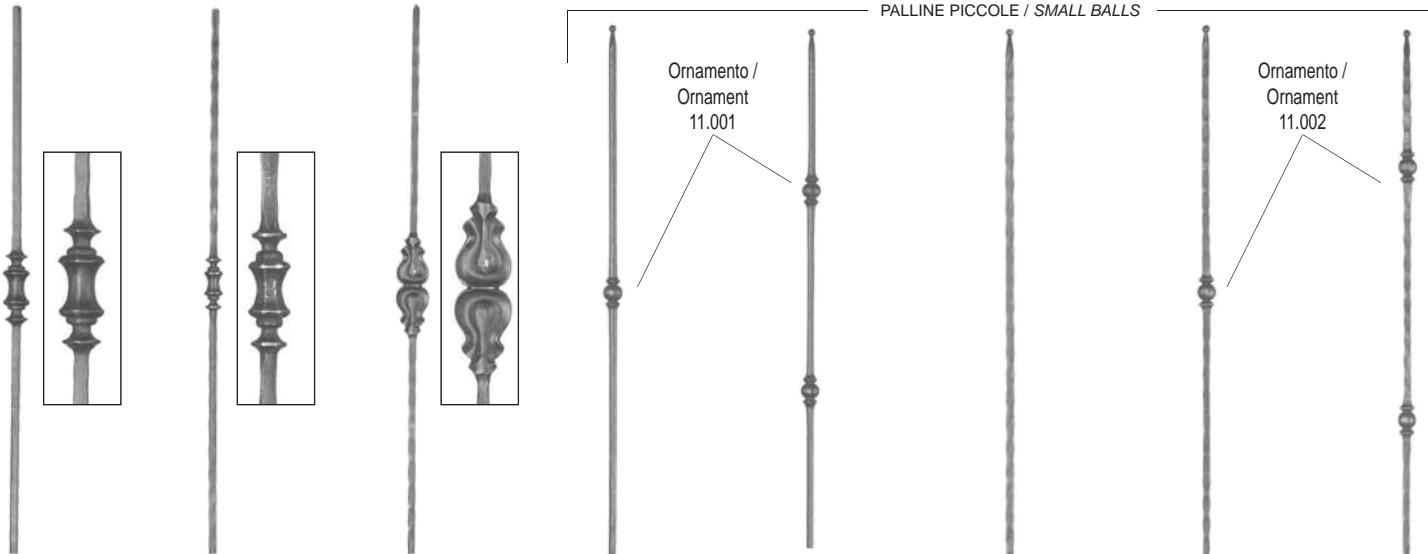

H.1000 mm. Art. 11.041.04 □ 14 circa
 H.1000 mm. Art. 11.041.05 □ 12 circa
 H.1000 mm. Art. 11.041.06 □ 12 circa
 Tondo / Round H.1000 mm. Art. 11.041.07 Ø 14 circa
 Tondo / Round H.1000 mm. Art. 11.041.08 Ø 14 circa
 H.1000 mm. Art. 11.041.09 □ 14 circa
 H.1000 mm. Art. 11.041.10 □ 14 circa
 H.1000 mm. Art. 11.041.11 □ 14 circa

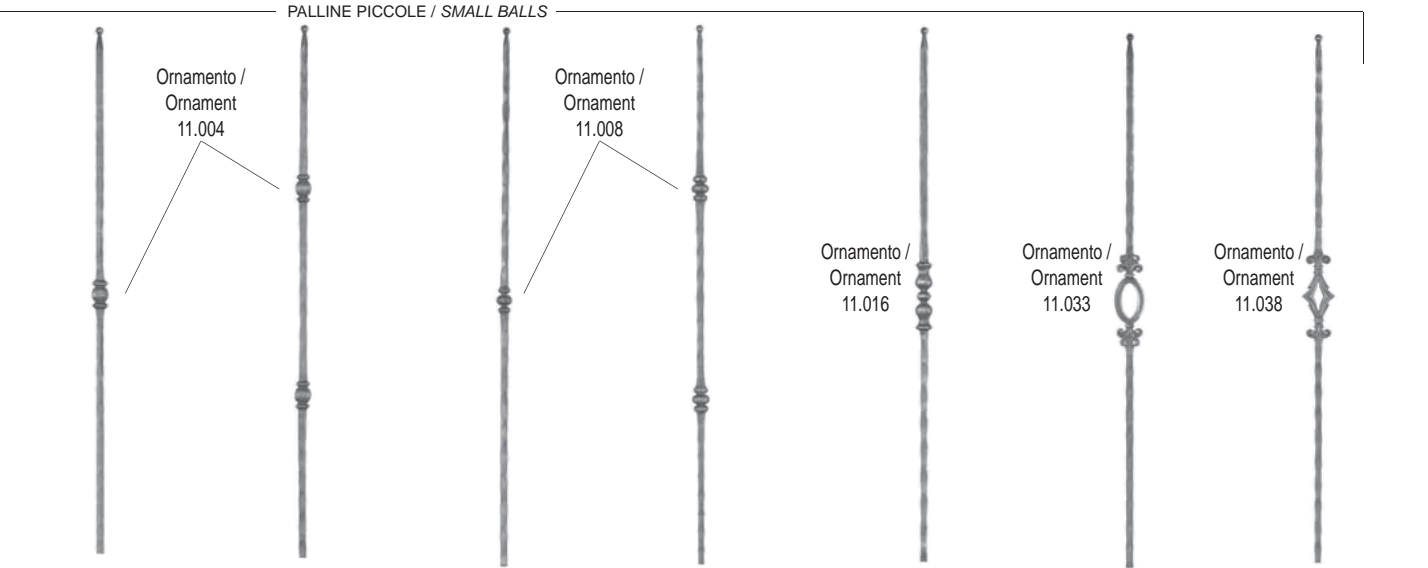

H.1000 mm. Art. 11.041.12 □ 14 circa
 H.1000 mm. Art. 11.041.13 □ 14 circa
 H.1000 mm. Art. 11.041.14 □ 14 circa
 H.1000 mm. Art. 11.041.15 □ 14 circa
 H.1000 mm. Art. 11.041.17 □ 14 circa
 H.1000 mm. Art. 11.041.18 □ 14 circa
 H.1000 mm. Art. 11.041.19 □ 14 circa

Tutte le parti di questo catalogo - foto comprese - sono di proprietà Euro-Fer. La riproduzione, anche parziale, è vietata in ogni forma e con ogni mezzo. / Every part of this catalogue - photos included - is Euro-Fer's property. All forms of copying are strictly prohibited.



PALLINE PICCOLE / SMALL BALLS

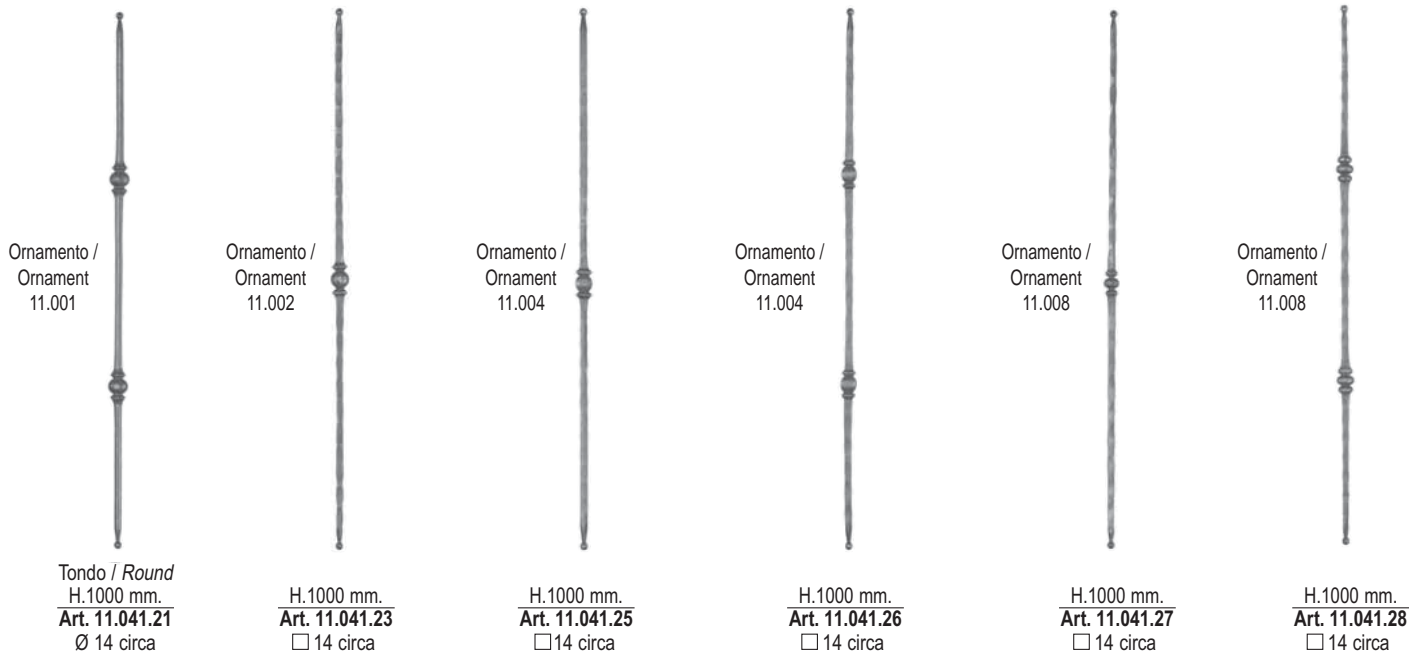

PALLINE PICCOLE / SMALL BALLS

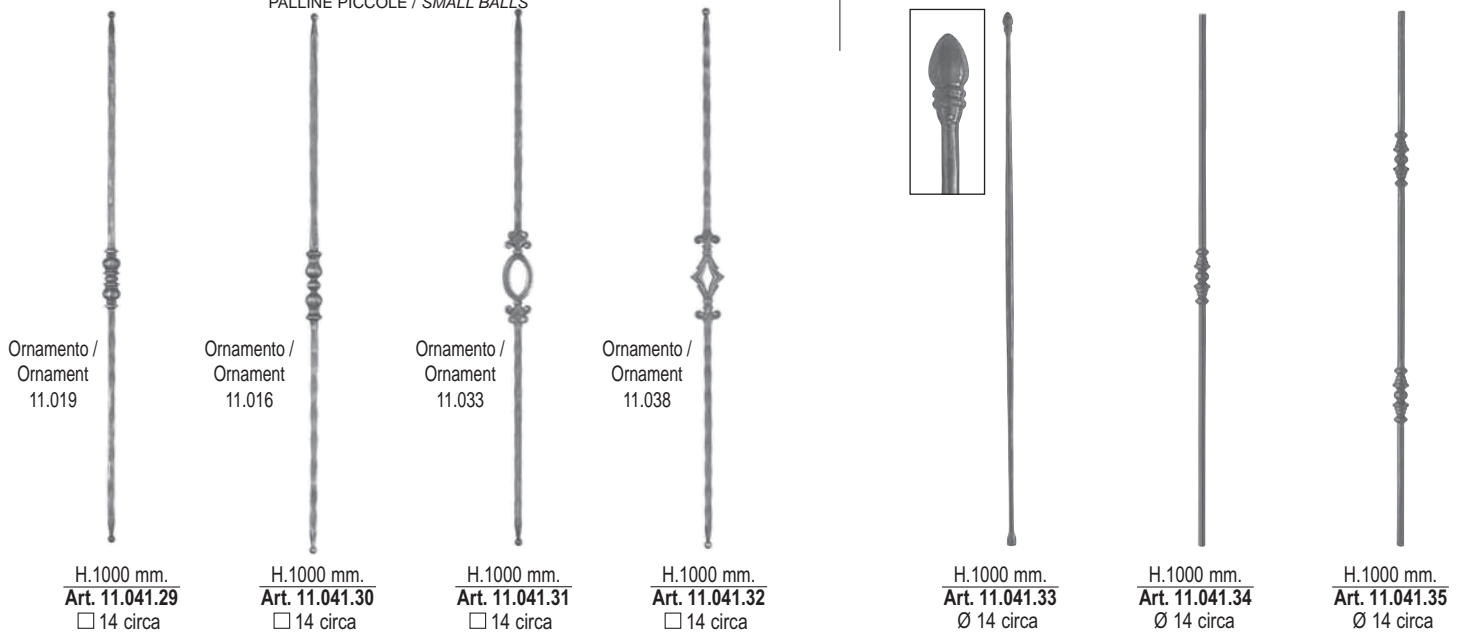

Tutte le parti di questo catalogo - foto comprese - sono di proprietà Euro-Fer. La riproduzione, anche parziale, è vietata in ogni forma e con ogni mezzo. / Every part of this catalogue - photos included - is Euro-Fer's property. All forms of copying are strictly prohibited.

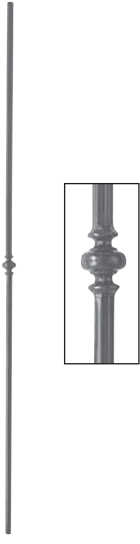

H.1000 mm.
Art. 11.041.36
Ø 12 mm circa



H.1000 mm.
Art. 11.041.37
Ø 12 mm circa



H.1000 mm.
Art. 11.041.38
□ 14 circa



H. 1000 mm
Art. 11.041.39
Ø 12 mm circa



H.1000 mm.
Art. 11.041.40
□ 14 mm circa

Fuori Produzione
Out of Production

Art. 11.041.41



H.1000 mm.
Art. 11.041.42
Ø 14 mm circa

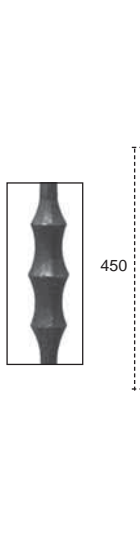

H.1000 mm.
Art. 11.041.43
Ø 14 mm circa



H.1000 mm.
Art. 11.041.44
Ø 14 mm circa



H.1000 mm.
Art. 11.041.45
Ø 14 mm circa



H.1000 mm.
Art. 11.041.46
□ 14 mm circa



H.1000 mm.
Art. 11.041.47
Ø 14 mm circa



H.1000 mm.
Art. 11.041.48
Ø 14 mm circa



H.1000 mm.
Art. 11.041.49
Ø 14 mm circa



H.1000 mm.
Art. 11.041.50
Ø 14 mm circa

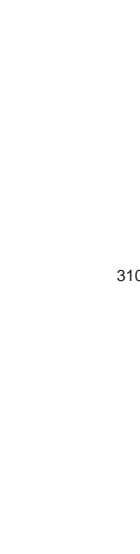

H.1000 mm.
Art. 11.041.51
Ø 14 mm circa



H.1000 mm
Art. 11.041.52
□ 12 mm ca.



H.1000 mm
Art. 11.041.53
□ 12 mm ca.



H.1000 mm
Art. 11.041.54
Ø 12 mm ca.



H.1000 mm
Art. 11.041.55
Ø 12 mm ca.



H.1000 mm
Art. 11.041.68 Ø 12 ca.
Art. 11.041.69 Ø 14 ca.



H.1000 mm
Art. 11.041.70
□ 14 mm ca.

Smussato / Blunted



H.1000 mm
Art. 11.041.71
□ 14 mm ca.

Smussato / Blunted



ELEMENTI IN FERRO FORGIATO E CAPISALDI
FORGED BARS AND POSTS



H.1000 mm
Art. 11.041.72
□ 12 mm ca.

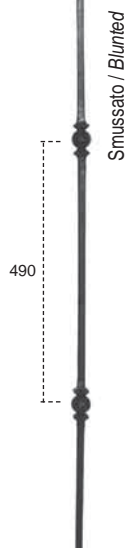

H.1000 mm
Art. 11.041.73
□ 12 mm ca.



H.1000 x L.120 mm
Art. 11.041.79
□ 14 mm ca.

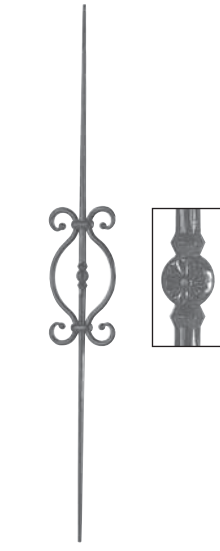

H.1000 X L.135. mm
Art. 11.041.80
Ø 14 mm circa



H.1000 X L.135 mm
Art. 11.041.81
Ø 14 mm circa

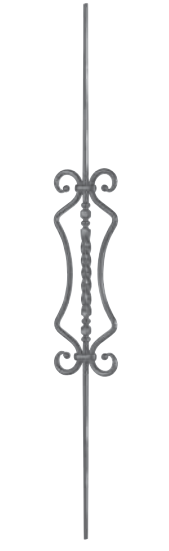

H.1000 X L.135 mm.
Art. 11.041.82
Ø 14 mm circa



H.1000 X L.135 mm.
Art. 11.041.83
Ø 12 mm circa



H.1000 X L.125 mm.
Art. 11.041.84
□ 14 mm circa



H.1000 X L.125 mm.
Art. 11.041.85
Ø 14 mm circa



H.1000 X L.125 mm.
Art. 11.041.86
□ 14 mm circa



Liscio / Smooth
H. 1000 mm
Art. 11.041.100 Ø 12 c.a.



Art. 11.041.104



Art. 11.041.105



Art. 11.041.108



Forgiato / Forged
H.1000 mm
Art. 11.041.109 Ø 12 ca.



Art. 11.041.110



Forgiato / Forged
H.1000 mm
Art. 11.041.111 Ø12 ca.

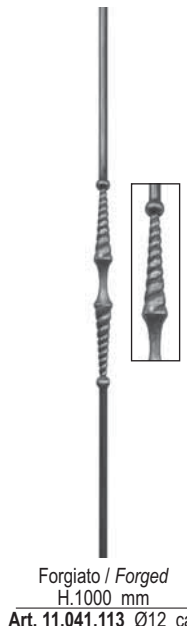

Forgiato / Forged
H.1000 mm
Art. 11.041.113 Ø12 ca.

Tutte le parti di questo catalogo - foto comprese - sono di proprietà Euro-Fer. La riproduzione, anche parziale, è vietata in ogni forma e con ogni mezzo. / Every part of this catalogue - photos included - is Euro-Fer's property. All forms of copying are strictly prohibited.

Fuori Produzione
Out of Production

Art. 11.041.115



Smussato / Blunted
H.1000 mm
Art. 11.041.118 □ 13 ca



Battuto / Beaten
H.1100 mm.
Art. 11.042 □ 20



Battuto / Beaten
H.1100 mm.
Art. 11.043 □ 25
Art. 11.044 □ 30



H.1100 mm.
Art. 11.044.01 □ 20



H.1100 mm.
Art. 11.044.02 □ 25
Art. 11.044.03 □ 30



H.1100 mm.
Art. 11.044.04 □ 20



H.1100 mm.
Art. 11.044.04 □ 20
Art. 11.044.05 □ 25
Art. 11.044.06 □ 30



H.1200 mm.
Art. 11.044.07 □ 20
Art. 11.044.08 □ 25
Art. 11.044.09 □ 30

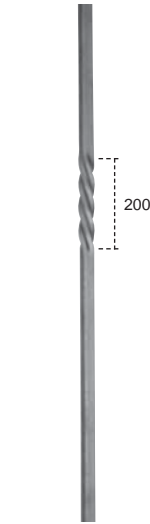

In Spigolo / Edged Bar
H.1200 mm.
Art. 11.045 □ 25
Art. 11.046 □ 30



H.1100 mm.
Art. 11.047 □ 20
Art. 11.048 □ 25
Art. 11.049 □ 30



Martellato / Hammered
H.1100 mm.
Art. 11.049.01 □ 20
Art. 11.049.02 □ 25
Art. 11.049.03 □ 30



Liscio / Smooth
H.1200 mm
Art. 11.049.08
Ø 25 circa

Fuori Produzione
Out of Production

Art. 11.049.11

Fuori Produzione
Out of Production

Art. 11.049.12



In Spigolo / Edged Bar
H.1200 mm.
Art. 11.050 □ 25
Art. 11.051 □ 30



Martellato / Hammered
H.1100 mm.
Art. 11.052 □ 20
Art. 11.052.01 □ 25
Art. 11.052.02 □ 30



H.1100 mm.
Art. 11.053 □ 20
Art. 11.053.01 □ 25
Art. 11.053.02 □ 30



H.1200 mm.
Art. 11.053.03 □ 25
Art. 11.053.04 □ 30



H.1200 mm.
Art. 11.053.05 □ 25
Art. 11.053.06 □ 30

Tutte le parti di questo catalogo - foto comprese - sono di proprietà Euro-Fer. La riproduzione, anche parziale, è vietata in ogni forma e con ogni mezzo. / Every part of this catalogue - photos included - is Euro-Fer's property. All forms of copying are strictly prohibited.

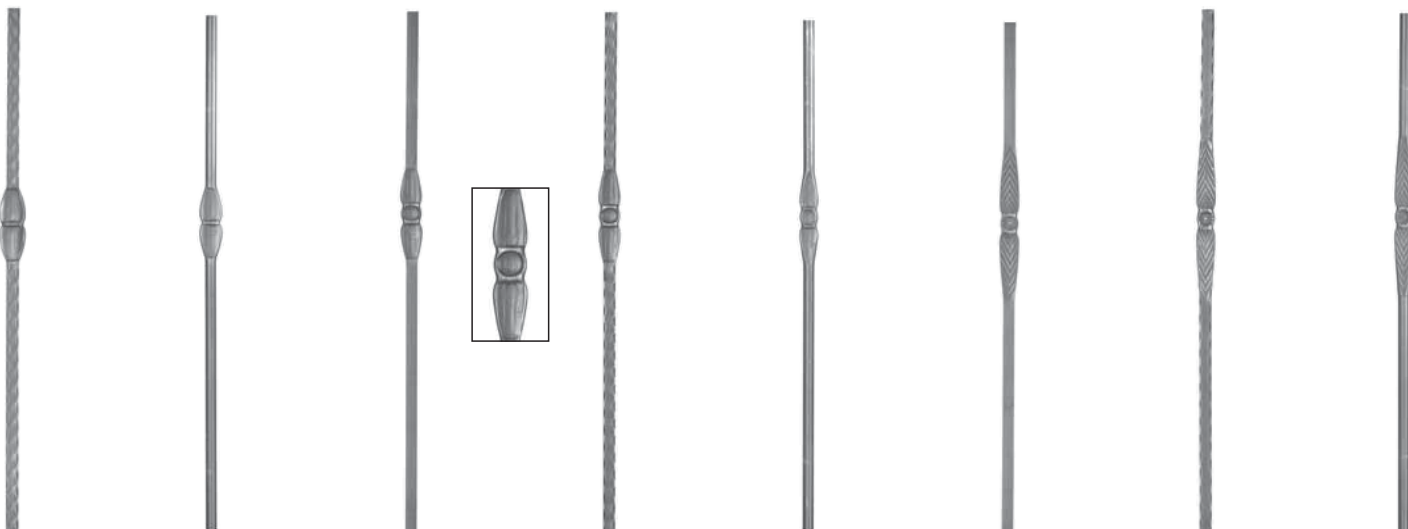

Martellato / Hammered
H.1200 mm.
Art. 11.053.07 □ 25
Art. 11.053.08 □ 30

Tondo / Round
H.1200 mm.
Art. 11.053.09 Ø 25
Art. 11.053.10 Ø 30

H.1200 mm.
Art. 11.053.11 □ 25
Art. 11.053.12 □ 30

Martellato / Hammered
H.1200 mm.
Art. 11.053.13 □ 25
Art. 11.053.14 □ 30

Tondo / Round
H.1200 mm.
Art. 11.053.15 Ø 25
Art. 11.053.16 Ø 30

H.1200 mm.
Art. 11.053.17 □ 20
Art. 11.053.18 □ 25
Art. 11.053.19 □ 30

Martellato / Hammered
H.1200 mm.
Art. 11.053.20 □ 20
Art. 11.053.21 □ 25
Art. 11.053.22 □ 30

Tondo / Round
H.1200 mm.
Art. 11.053.23 Ø 25
Art. 11.053.24 Ø 30

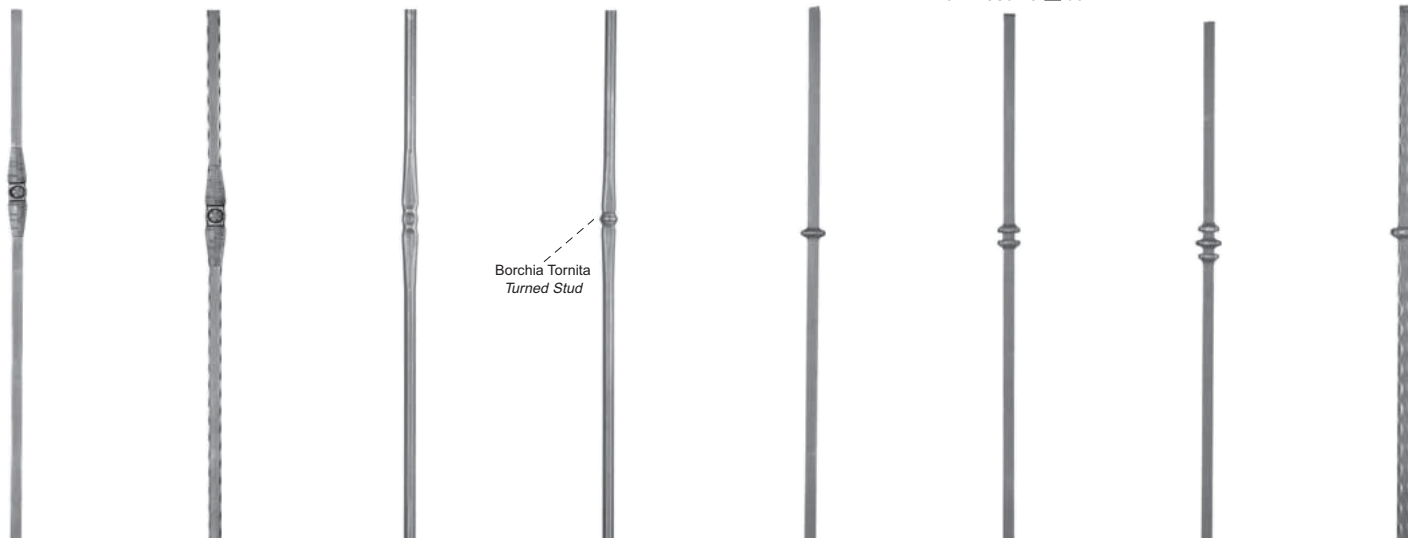

H.1200 mm.
Art. 11.053.25 □ 25
Art. 11.053.26 □ 30

Martellato / Hammered
H.1200 mm.
Art. 11.053.27 □ 25
Art. 11.053.28 □ 30

Tondo / Round
H.1200 mm.
Art. 11.053.29 Ø 25

Tondo / Round
H.1200 mm.
Art. 11.053.30 Ø 25

H.1200 mm.
Art. 11.053.31 □ 25
Art. 11.053.32 □ 30

H.1200 mm.
Art. 11.053.33 □ 25
Art. 11.053.34 □ 30

H.1200 mm.
Art. 11.053.35 □ 25
Art. 11.053.36 □ 30

Martellato / Hammered
H.1200 mm.
Art. 11.053.37 □ 25
Art. 11.053.38 □ 30

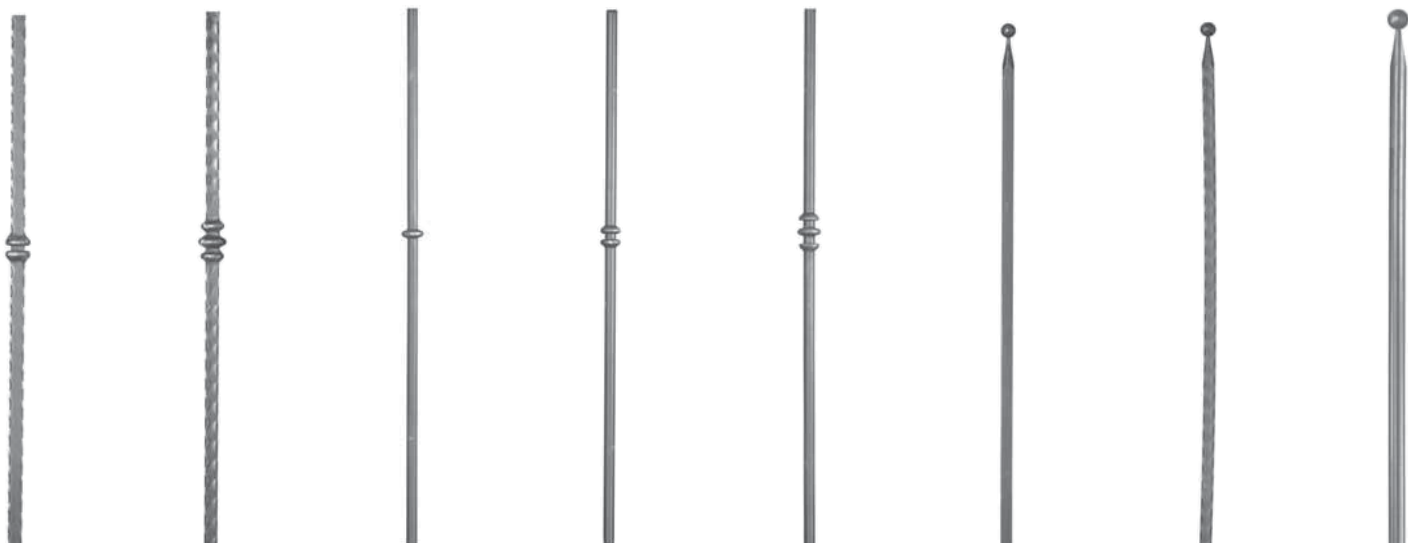

Martellato / Hammered
H.1200 mm.
Art. 11.053.39 □ 25
Art. 11.053.40 □ 30

Martellato / Hammered
H.1200 mm.
Art. 11.053.41 □ 25
Art. 11.053.42 □ 30

Tondo / Round
H.1200 mm.
Art. 11.053.43 Ø 25
Art. 11.053.44 Ø 30

Tondo / Round
H.1200 mm.
Art. 11.053.45 Ø 25
Art. 11.053.46 Ø 30

Tondo / Round
H.1200 mm.
Art. 11.053.47 Ø 25
Art. 11.053.48 Ø 30

H.1200 mm.
Art. 11.053.49 □ 25
Art. 11.053.50 □ 30

Martellato / Hammered
H.1200 mm.
Art. 11.053.51 □ 25
Art. 11.053.52 □ 30

Tondo / Round
H.1200 mm.
Art. 11.053.53 Ø 25
Art. 11.053.54 Ø 30

Tutte le parti di questo catalogo - foto comprese - sono di proprietà Euro-Fer. La riproduzione, anche parziale, è vietata in ogni forma e con ogni mezzo. / Every part of this catalogue - photos included - is Euro-Fer's property. All forms of copying are strictly prohibited.



H.1200 mm.
Art. 11.053.55 □ 25
Art. 11.053.56 □ 30

Martellato / *Hammered*
H.1200 mm.
Art. 11.053.57 □ 25
Art. 11.053.58 □ 30

Tondo / *Round*
H.1200 mm.
Art. 11.053.59 Ø 25
Art. 11.053.60 Ø 30

H.1200 mm.
Art. 11.053.61 □ 25
Art. 11.053.62 □ 30

Martellato / *Hammered*
H.1200 mm.
Art. 11.053.63 □ 25
Art. 11.053.64 □ 30

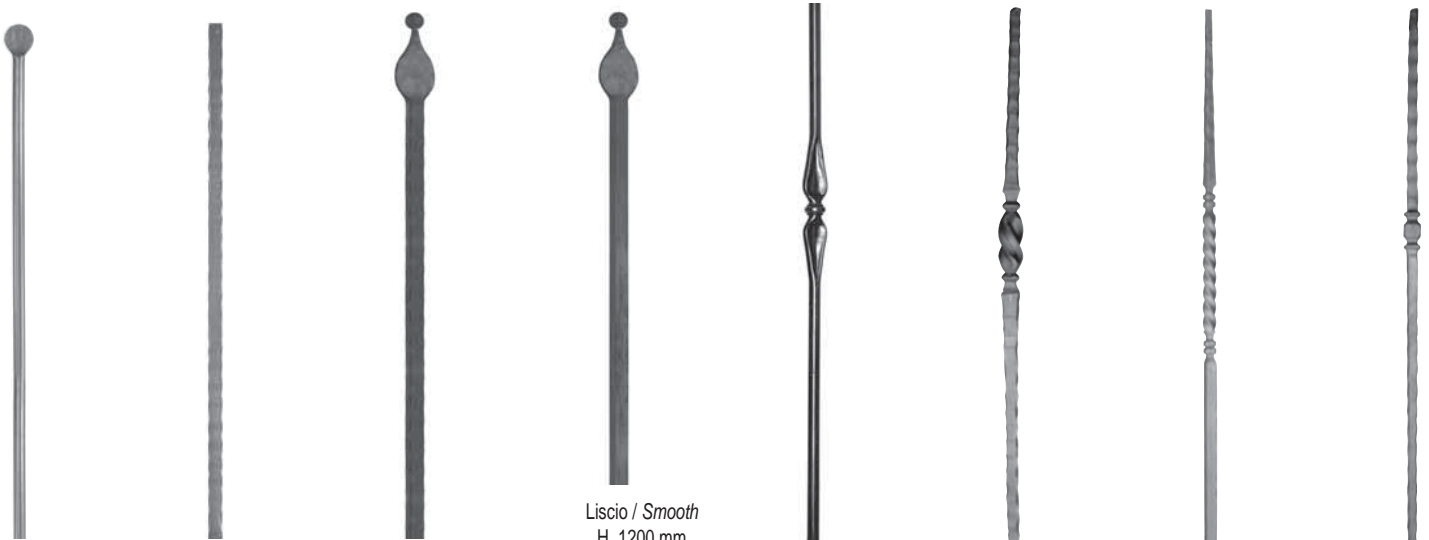

Tondo / *Round*
H.1200 mm.
Art. 11.053.65 Ø 25
Art. 11.053.66 Ø 30

Martellato / *Hammered*
H.1200 mm.
Art. 11.053.67 □ 25 circa
Art. 11.053.68 □ 30 circa

H. 1200 mm
Martellato / *Hammered*
Art. 11.053.69 □ 30x30
Art. 11.053.70 □ 25x25

Liscio / *Smooth*
H. 1200 mm
Art. 11.053.71 □ 30x30
Art. 11.053.72 □ 25x25
Art. 11.053.73 Ø 30
Art. 11.053.74 Ø 25

Liscio / *Smooth*
H.1200 mm
Art. 11.053.90
Ø 25 circa

H.1200 mm.
Art. 11.054
□ 25 circa

H.1200 mm.
Art. 11.055
□ 25 circa

H.1200 mm.
Art. 11.056
□ 25 circa

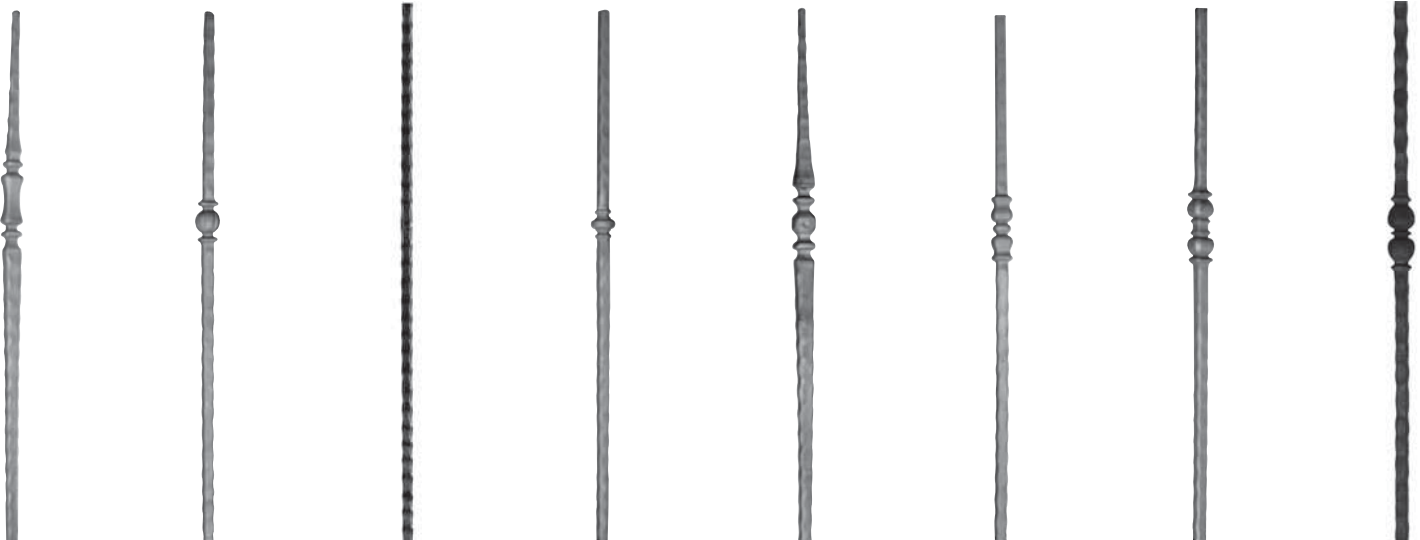

H.1200 mm.
Art. 11.057 □ 25 circa
Art. 11.058 □ 30 circa

H.1200 mm.
Art. 11.059 □ 25 circa
Art. 11.060 □ 30 circa

H.1200 mm.
Art. 11.059.P
□ 25 circa

H.1200 mm.
Art. 11.061 □ 25 circa
Art. 11.062 □ 30 circa

H.1200 mm.
Art. 11.063
□ 25 circa

H.1200 mm.
Art. 11.064
□ 25 circa

H.1200 mm.
Art. 11.065
□ 25 circa

H.1200 mm.
Art. 11.066
□ 25 circa

Tutte le parti di questo catalogo - foto comprese - sono di proprietà Euro-Fer. La riproduzione, anche parziale, è vietata in ogni forma e con ogni mezzo. / Every part of this catalogue - photos included - is Euro-Fer's property. All forms of copying are strictly prohibited.

ELEMENTI IN FERRO FORGIATO E CAPISALDI
FORGED BARS AND POSTS



H.1200 mm.
Art. 11.067
□ 25 circa

H.1200 mm
Art. 11.067.01
Ø 25 circa

H.1200 mm.
Art. 11.068
Ø 25 mm

H.1200 mm.
Art. 11.068.01
Ø 25 mm

H.1200 mm.
Art. 11.069
Ø 30 circa

H.1200 mm.
Art. 11.070
□ 25 mm

Smussato / Blunted
H.1200 mm
Art. 11.070.01
□ 25 mm ca.



H.1200 mm.
Art. 11.071
□ 25 mm

Forgiato / Forged
H.1200 mm
Art. 11.071.01
□ 25 circa

H.1200 mm.
Art. 11.072
Ø 25 mm

H.1200 mm.
Art. 11.073
□ 25 mm

Martellato / Hammered
H.1200 mm.
Art. 11.074
□ 25 mm

Liscio / Smooth
H.1200 mm.
Art. 11.075
Ø 25 mm

H.240 x L.200 mm
Art. 11.077.01 Ø 40 mm ca.



Tondo Lavorato / Round Hammered
H.1100 X L.400 mm.
Art. 11.077
Ø 30 mm



H.870 X L.480 mm.
Art. 11.078



Art. 11.079



H.1100 x L.480 mm
Art. 11.080

Tutte le parti di questo catalogo - foto comprese - sono di proprietà Euro-Fer. La riproduzione, anche parziale, è vietata in ogni forma e con ogni mezzo. / Every part of this catalogue - photos included - is Euro-Fer's property. All forms of copying are strictly prohibited.

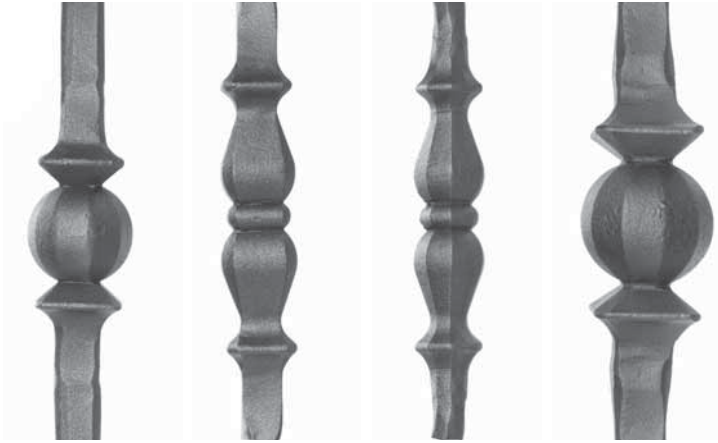

H.160 mm.
Art. 11.100
□ 14 mm circa

H.160 mm.
Art. 11.101
□ 14 mm circa

H.160 mm.
Art. 11.102
Ø 12 mm circa

H.200 mm.
Art. 11.150
□ 24 mm circa

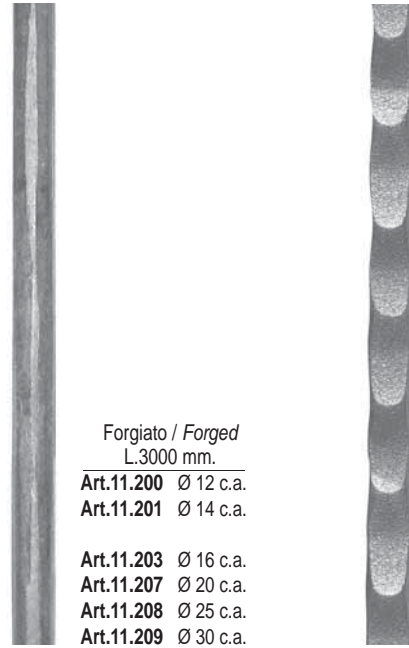

Forgiato / Forged
L.3000 mm.

Art.11.200 Ø 12 c.a.

Art.11.201 Ø 14 c.a.

Art.11.203 Ø 16 c.a.

Art.11.207 Ø 20 c.a.

Art.11.208 Ø 25 c.a.

Art.11.209 Ø 30 c.a.

Forgiato / Forged
L.3000 mm.

Art.11.210 □ 12 c.a.

Art.11.211 □ 14 c.a.



Rose Collection
CRYSTALS FROM
SWAROVSKI®

www.rosecollection.it





H.3000 mm.		H.6000 mm.	
Art. 12.001	≅ 25 X 6	Art. 12.007	≅ 25 X 6
Art. 12.002	≅ 25 X 8	Art. 12.008	≅ 25 X 8
Art. 12.003	≅ 30 X 6	Art. 12.009	≅ 30 X 6
Art. 12.004	≅ 30 X 8	Art. 12.010	≅ 30 X 8
Art. 12.004.01	≅ 35 X 8	Art. 12.010.01	≅ 35 X 8
Art. 12.005	≅ 40 X 8	Art. 12.011	≅ 40 X 8
Art. 12.006	≅ 50 X 10	Art. 12.012	≅ 50 X 10
Art. 12.006.01	≅ 20 X 5	Art. 12.012.01	≅ 20 X 5
Art. 12.006.02	≅ 20 X 6	Art. 12.012.02	≅ 20 X 6
Art. 12.006.03	≅ 20 X 8	Art. 12.012.03	≅ 20 X 8
Art. 12.006.04	≅ 25 X 10	Art. 12.012.04	≅ 25 X 10
Art. 12.006.05	≅ 25 X 12	Art. 12.012.05	≅ 25 X 12
Art. 12.006.06	≅ 30 X 4	Art. 12.012.06	≅ 30 X 4
Art. 12.006.07	≅ 30 X 10	Art. 12.012.07	≅ 30 X 10
Art. 12.006.08	≅ 30 X 12	Art. 12.012.08	≅ 30 X 12
Art. 12.006.09	≅ 35 X 10	Art. 12.012.09	≅ 35 X 10
Art. 12.006.10	≅ 40 X 6	Art. 12.012.10	≅ 40 X 6
Art. 12.006.11	≅ 40 X 10	Art. 12.012.11	≅ 40 X 10
Art. 12.006.12	≅ 50 X 8	Art. 12.012.12	≅ 50 X 8
Art. 12.006.13	≅ 100 X 10	Art. 12.012.13	≅ 100 X 10
Art. 12.006.14	≅ 100 X 8	Art. 12.012.14	≅ 100 X 8
Art. 12.006.15	≅ 100 X 6	Art. 12.012.15	≅ 100 X 6
Art. 12.006.16	≅ 70 X 6	Art. 12.012.16	≅ 70 X 6
Art. 12.006.17	≅ 50 X 6	Art. 12.012.17	≅ 50 X 6
Art. 12.006.18	≅ 60 X 6	Art. 12.012.18	≅ 60 X 6

Martellato su due spigoli
Hammered on the upper edges

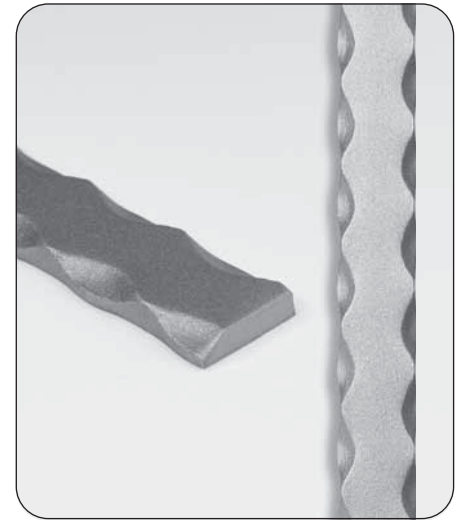

H.400 X L.100 mm.
Art. 12.013 ≅ 40 X 8
Art. 12.014 ≅ 50 X 10
Art. 12.014.01 ≅ 50 X 8



H.400 X L.130 mm.
Art. 12.015 ≅ 40 X 8
Art. 12.016 ≅ 50 X 10
Art. 12.016.01 ≅ 50 X 8



H.400 X L.100 mm.
Art. 12.017 ≅ 40 X 8
Art. 12.018 ≅ 50 X 10



H.400 X L.180 mm.
Art. 12.018.01 ≅ 40 X 8



H.450 mm.
Art. 12.019 ≅ 40 X 8



H.460 mm.
Art. 12.020 ≅ 40 X 8



H.680 X L.140 mm.
Art. 12.021 ≅ 40 X 8
Art. 12.022 ≅ 50 X 10
Art. 12.022.02 ≅ 50 X 8



H.840 X L.140 mm.
Art. 12.022.01 ≅ 40 X 8
Art. 12.022.03 ≅ 50 X 8



H.400 X L.400 mm.
Art. 12.023 ≅ 25 X 8
Art. 12.024 ≅ 30 X 8
Art. 12.025 ≅ 40 X 8
Art. 12.025.01 ≅ 35 X 8
Art. 12.025.02 ≅ 50 X 8



H.200 X L.200 mm.
Art. 12.026 ≅ 25 X 8 (mis. int. 130)
Art. 12.027 ≅ 30 X 8 (mis. int. 125)
Art. 12.028 ≅ 40 X 8 (mis. int. 120)

Martellato su due spigoli e rigato
Hammered on the upper edges and fluted

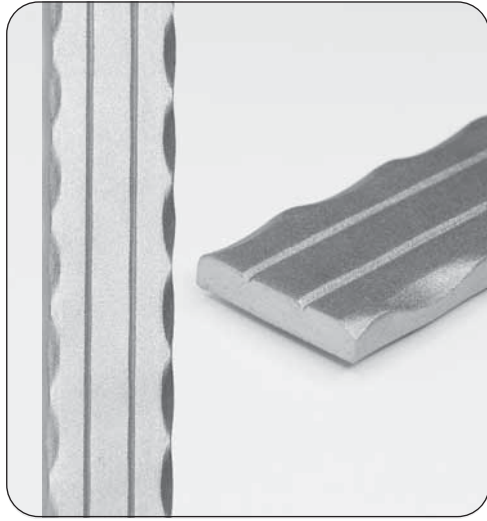

H.3000 mm.
Art. 12.029 ≙ 40 X 8
Art. 12.029.01 ≙ 50 X 10
Art. 12.029.02 ≙ 40 X 6
Art. 12.029.03 ≙ 30 X 8

H.6000 mm.
Art. 12.030 ≙ 40 X 8
Art. 12.030.01 ≙ 50 X 10
Art. 12.030.02 ≙ 40 X 6
Art. 12.030.03 ≙ 30 X 8

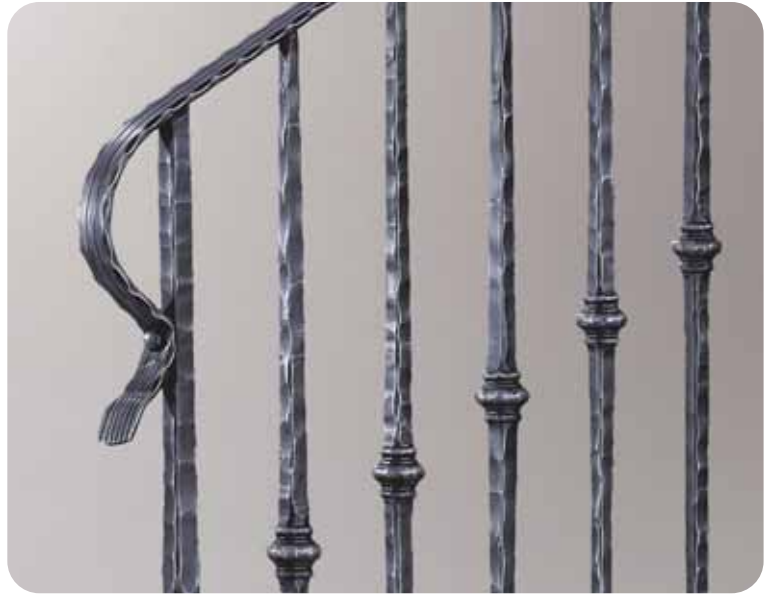

H.460 mm.
Art. 12.031 ≙ 40 X 8

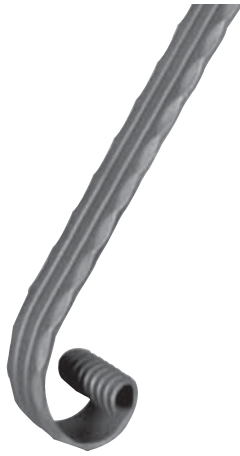

H.400 X L.100 mm.
Art. 12.032 ≙ 40 X 8
Art. 12.032.02 ≙ 50 X 10



H.400 X L.180 mm.
Art. 12.032.01 ≙ 40 X 8
Art. 12.032.03 ≙ 50 X 10



H.450 mm.
Art. 12.033 ≙ 40 X 8



H.680 X L.140 mm.
Art. 12.034 ≙ 40 X 8
Art. 12.034.03 ≙ 50 X 10



H.840 X L.140 mm.
Art. 12.034.01 ≙ 40 X 8
Art. 12.034.04 ≙ 50 X 10



H.720 X L.250 mm.
Art. 12.034.02 ≙ 40 X 8



H.200 X L.200 mm.
Art. 12.036 ≙ 40 X 8 (mis. int. 120)



H.400 X L.400 mm.
Art. 12.035 ≙ 40 X 8
Art. 12.035.01 ≙ 50 X 10

Martellato su due spigoli e decorato
Hammered on the upper edges and decorated



H.3000 mm.
Art. 12.037 \neq 40 X 4
Art. 12.038 \neq 40 X 8
H.6000 mm.
Art. 12.039 \neq 40 X 4
Art. 12.040 \neq 40 X 8



H.400 X L.180 mm.
Art. 12.040.01 \neq 40 X 8



H.200 X L.200 mm.
Art. 12.041 \neq 40 X 8 (mis. int. 120)



H.830 X L.140 mm.
Art. 12.042 \neq 40 X 8



H.400 X L.100 mm.
Art. 12.042.01 \neq 40 X 8



H.460 mm.
Art. 12.043 \neq 40 X 8



H.680 mm.
Art. 12.043.01 \neq 40 X 8



H.400 X L.400 mm.
Art. 12.044 \neq 40 X 8

Tutte le parti di questo catalogo - foto comprese - sono di proprietà Euro-Fer. La riproduzione, anche parziale, è vietata in ogni forma e con ogni mezzo. / Every part of this catalogue - photos included - is Euro-Fer's property. All forms of copying are strictly prohibited.

Martellato su due spigoli e decorato
Hammered on the upper edges and decorated

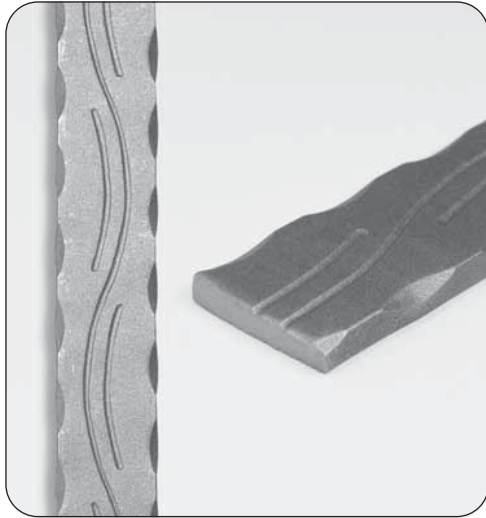

≠ 40 X 8
Art. 12.045 H.3000 mm.
Art. 12.046 H.6000 mm.



H.400 X L.180 mm.
Art. 12.046.01 ≠ 40 X 8

H.400 X L.100 mm.
Art. 12.047 ≠ 40 X 8

H.400 X L.400 mm.
Art. 12.047.01 ≠ 40 X 8

H.460 mm.
Art. 12.048 ≠ 40 X 8

H.650 mm.
Art. 12.048.01 ≠ 40 X 8

H.200 X L.200 mm.
Art. 12.049 ≠ 40 X 8 (mis. int. 120)

Martellato su due spigoli e decorato
Hammered on the upper edges and decorated



≠ 40 X 8
Art. 12.050 H.3000 mm.
Art. 12.051 H.6000 mm.

H.400 X L.400 mm.
Art. 12.051.01 ≠ 40 X 8

H.460 mm.
Art. 12.052 ≠ 40 X 8

H.200 X L.200 mm.
Art. 12.052.01 ≠ 40 X 8 (mis. int. 120)

Corrimano classico
Classic handrail



H.6000 mm.
Art. 12.053.02 ≙ 40 X 8
Art. 12.054.02 ≙ 50 X 10

H.3000 mm.
Art. 12.053 ≙ 40 X 8
Art. 12.054 ≙ 50 X 10



H.450 mm.
Art. 12.053.01 ≙ 40 X 8
Art. 12.054.01 ≙ 50 X 10



H.400 X L.400 mm.
Art. 12.055 ≙ 40 X 8
Art. 12.055.01 ≙ 50 X 10



H.330 X L.100 mm.
Art. 12.056 ≙ 40 X 8
H.330 X L.135 mm.
Art. 12.057 ≙ 50 X 10



H.400 X L.180 mm.
Art. 12.056.01 ≙ 40 X 8
Art. 12.057.01 ≙ 50 X 10



H.460 X L.140 mm.
Art. 12.057.02 ≙ 50 X 10
Art. 12.058 ≙ 40 X 8



H.200 X L.200 mm. (mis. int. 120)
Art. 12.058.01 ≙ 40 X 8
Art. 12.058.02 ≙ 50 X 10



Mezzotondo
Half round

H.3000 mm.	
Art. 12.059	≠ 30 X 8
Art. 12.059.02	≠ 25 X 7
Art. 12.060	≠ 30 X 10
Art. 12.061	≠ 35 X 8
Art. 12.062	≠ 35 X 10
Art. 12.063	≠ 40 X 8
Art. 12.064	≠ 40 X 10
Art. 12.065	≠ 40 X 12
Art. 12.066	≠ 50 X 10
Art. 12.067	≠ 50 X 12

H.6000 mm.	
Art. 12.059.01	≠ 30 X 8
Art. 12.060.01	≠ 30 X 10
Art. 12.061.01	≠ 35 X 8
Art. 12.062.01	≠ 35 X 10
Art. 12.063.01	≠ 40 X 8
Art. 12.064.01	≠ 40 X 10
Art. 12.065.01	≠ 40 X 12
Art. 12.066.01	≠ 50 X 10
Art. 12.067.01	≠ 50 X 12



H.400 X L.400 mm.	
Art. 12.067.02	≠ 30 X 8
Art. 12.067.03	≠ 30 X 10
Art. 12.067.04	≠ 35 X 8
Art. 12.067.05	≠ 35 X 10
Art. 12.067.06	≠ 40 X 8
Art. 12.067.07	≠ 40 X 10
Art. 12.067.08	≠ 40 X 12
Art. 12.067.09	≠ 50 X 10
Art. 12.067.10	≠ 50 X 12



H.400 X L.35 mm.

Art. 12.067.11	≠ 30 X 10
Art. 12.067.12	≠ 35 X 10
Art. 12.067.13	≠ 40 X 8
Art. 12.067.14	≠ 40 X 10
Art. 12.067.15	≠ 40 X 12
Art. 12.067.16	≠ 50 X 10
Art. 12.067.17	≠ 50 X 12

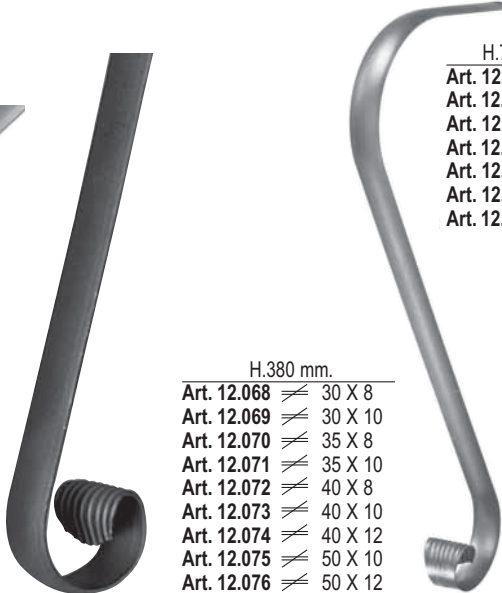

H.380 mm.

Art. 12.068	≠ 30 X 8
Art. 12.069	≠ 30 X 10
Art. 12.070	≠ 35 X 8
Art. 12.071	≠ 35 X 10
Art. 12.072	≠ 40 X 8
Art. 12.073	≠ 40 X 10
Art. 12.074	≠ 40 X 12
Art. 12.075	≠ 50 X 10
Art. 12.076	≠ 50 X 12

H.720 X L.250 mm.	
Art. 12.076.01	≠ 30 X 10
Art. 12.076.02	≠ 35 X 10
Art. 12.076.03	≠ 40 X 8
Art. 12.076.04	≠ 40 X 10
Art. 12.076.05	≠ 40 X 12
Art. 12.076.06	≠ 50 X 10
Art. 12.076.07	≠ 50 X 12

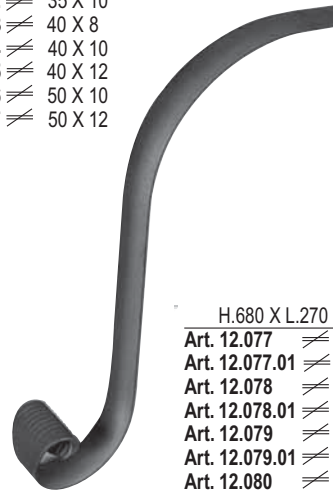

H.680 X L.270 mm.

Art. 12.077	≠ 30 X 10
Art. 12.077.01	≠ 35 X 10
Art. 12.078	≠ 40 X 8
Art. 12.078.01	≠ 40 X 10
Art. 12.079	≠ 40 X 12
Art. 12.079.01	≠ 50 X 12
Art. 12.080	≠ 50 X 10



H.200 X L.200 mm. (mis. int. 120)

Art. 12.080.01	≠ 30 X 8
Art. 12.080.02	≠ 40 X 8
Art. 12.080.03	≠ 50 X 10
Art. 12.080.04	≠ 40 X 10

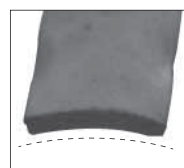
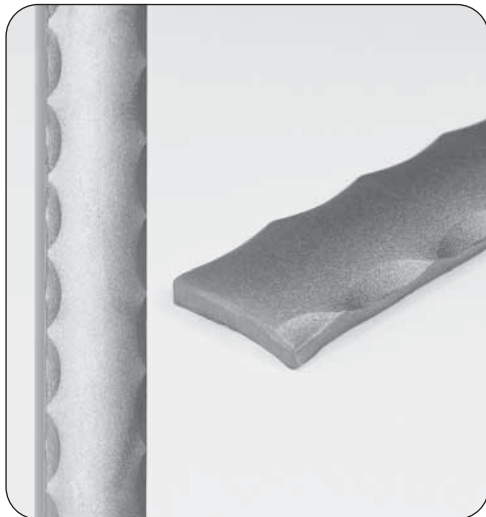
Ferro stondato
Rounded shape

≠ 40 X 8
Art. 12.081 H.3000 mm.
Art. 12.082 H.6000 mm.



H.380 X L.180 mm.
Art. 12.082.01 ≠ 40 X 8



H.400 X L.100 mm.
Art. 12.083 ≠ 40 X 8



H.400 X L.400 mm.
Art. 12.083.01 ≙ 50 X 14
Art. 12.083.02 ≙ 40 X 12
Art. 12.083.03 ≙ 45 X 12
Art. 12.083.04 ≙ 60 X 16



H.3000 mm.
Art. 12.084 ≙ 50 X 14
Art. 12.084.01 ≙ 40 X 12
Art. 12.084.02 ≙ 45 X 12
Art. 12.084.03 ≙ 60 X 16

H.6000 mm.
Art. 12.085 ≙ 50 X 14
Art. 12.085.01 ≙ 40 X 12
Art. 12.085.02 ≙ 45 X 12
Art. 12.085.03 ≙ 60 X 16



Corrimano sagomato
Shaped hand rail



H.400 mm.
Art. 12.086 ≙ 50 X 14
Art. 12.086.01 ≙ 40 X 12
Art. 12.086.02 ≙ 45 X 12
Art. 12.086.03 ≙ 60 X 16



H.300 X L.80 mm.
Art. 12.086.04 ≙ 50 X 14
Art. 12.086.05 ≙ 40 X 12
Art. 12.086.06 ≙ 45 X 12
Art. 12.086.07 ≙ 60 X 16



H.400 X L.35 mm.
Art. 12.086.08 ≙ 50 X 14
Art. 12.086.09 ≙ 40 X 12
Art. 12.086.10 ≙ 45 X 12
Art. 12.086.11 ≙ 60 X 16



H.100 X L.400 mm.
Art. 12.086.12 ≙ 50 X 14
Art. 12.086.13 ≙ 40 X 12
Art. 12.086.14 ≙ 45 X 12
Art. 12.086.15 ≙ 60 X 16



H.170 X L.400 mm.
Art. 12.087 ≙ 50 X 14
Art. 12.087.01 ≙ 40 X 12
Art. 12.087.02 ≙ 45 X 12
Art. 12.087.03 ≙ 60 X 16



H.680 mm.
Art. 12.087.04 ≙ 50 X 14
Art. 12.087.05 ≙ 40 X 12
Art. 12.087.06 ≙ 45 X 12
Art. 12.087.07 ≙ 60 X 16

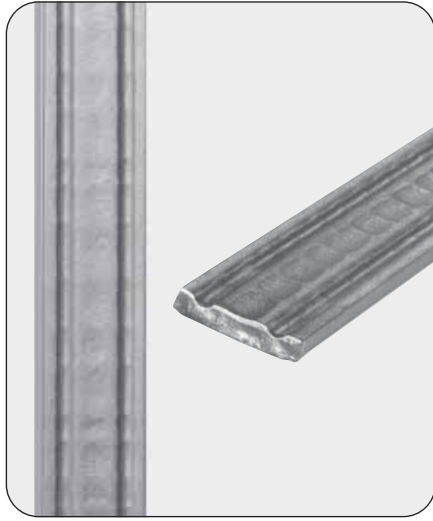

Corrimano rustico
Rustic handrail

≠ 40 X 8
Art. 12.087.08 H.3000 mm.
Art. 12.087.09 H.6000 mm.

H.100 X L.400 mm.
Art. 12.087.10 ≠ 40 X 8

H.180 X L.400 mm.
Art. 12.087.11 ≠ 40 X 8

H.840 X L.140 mm.
Art. 12.087.12 ≠ 40 X 8



H.680 mm.
Art. 12.087.13 ≠ 40 X 8

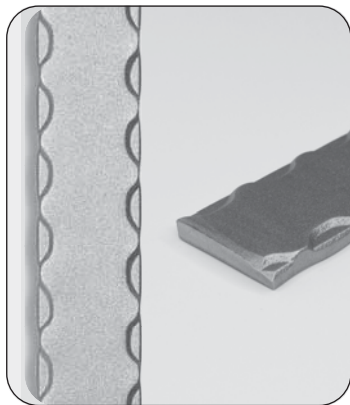

H.400 X L.400 mm.
Art. 12.087.14 ≠ 40 X 8

Battuto su due spigoli superiori (mod. DUNE)
Hammered on the upper edges (mod. DUNE)

≠ 40 X 8
Art. 12.087.15 H.3000 mm.
Art. 12.087.16 H.6000 mm.

H.100 X L.400 mm.
Art. 12.087.17 ≠ 40 X 8

H.180 X L.400 mm.
Art. 12.087.18 ≠ 40 X 8

H.680 mm.
Art. 12.087.19 ≠ 40 X 8

H.840 mm.
Art. 12.087.20 ≠ 40 X 8

H.400 X L.400 mm.
Art. 12.087.21 ≠ 40 X 8

Tutte le parti di questo catalogo - foto comprese - sono di proprietà Euro-Fer. La riproduzione, anche parziale, è vietata in ogni forma e con ogni mezzo. / Every part of this catalogue - photos included - is Euro-Fer's property. All forms of copying are strictly prohibited.

Martellato su due spigoli e decorato
Hammered on the upper edges and decorated



≠ 40 X 8
Art. 12.087.22 H.3000 mm.
Art. 12.087.23 H.6000 mm.

H.100 X L.400 mm.
Art. 12.087.24 ≠ 40 X 8

H.180 X L.400 mm.
Art. 12.087.25 ≠ 40 X 8

H.680 mm.
Art. 12.087.26 ≠ 40 X 8

H.460 mm.
Art. 12.087.27 ≠ 40 X 8

H.400 X L.400 mm.
Art. 12.087.28 ≠ 40 X 8

Martellato su due spigoli e decorato
Hammered on the upper edges and decorated

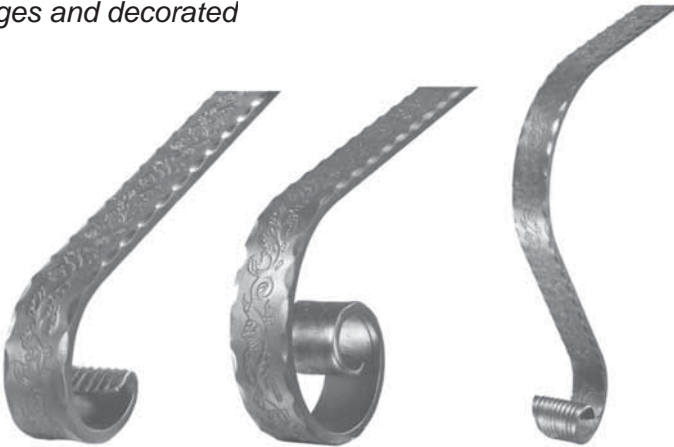

H.3000 mm
Art. 12.087.29 ≠ 50 X 10
Art. 12.087.36 ≠ 50 X 8
Art. 12.087.43 ≠ 40 X 8

H.6000 mm
Art. 12.087.30 ≠ 50 X 10
Art. 12.087.37 ≠ 50 X 8
Art. 12.087.44 ≠ 40 X 8

H.400 X L.100 mm.
Art. 12.087.31 ≠ 50 X 10
Art. 12.087.38 ≠ 50 X 8

H.400 X L.180 mm.
Art. 12.087.32 ≠ 50 X 10
Art. 12.087.39 ≠ 50 X 8

H.680 mm.
Art. 12.087.33 ≠ 50 X 10
Art. 12.087.40 ≠ 50 X 8

Art. 12.087.34
Art. 12.087.41

Art. 12.087.35
Art. 12.087.42

Non Prod. / Not Prod.

Non Prod. / Not Prod.



Tutte le parti di questo catalogo - foto comprese - sono di proprietà Euro-Fer. La riproduzione, anche parziale, è vietata in ogni forma e con ogni mezzo. / Every part of this catalogue - photos included - is Euro-Fer's property. All forms of copying are strictly prohibited.

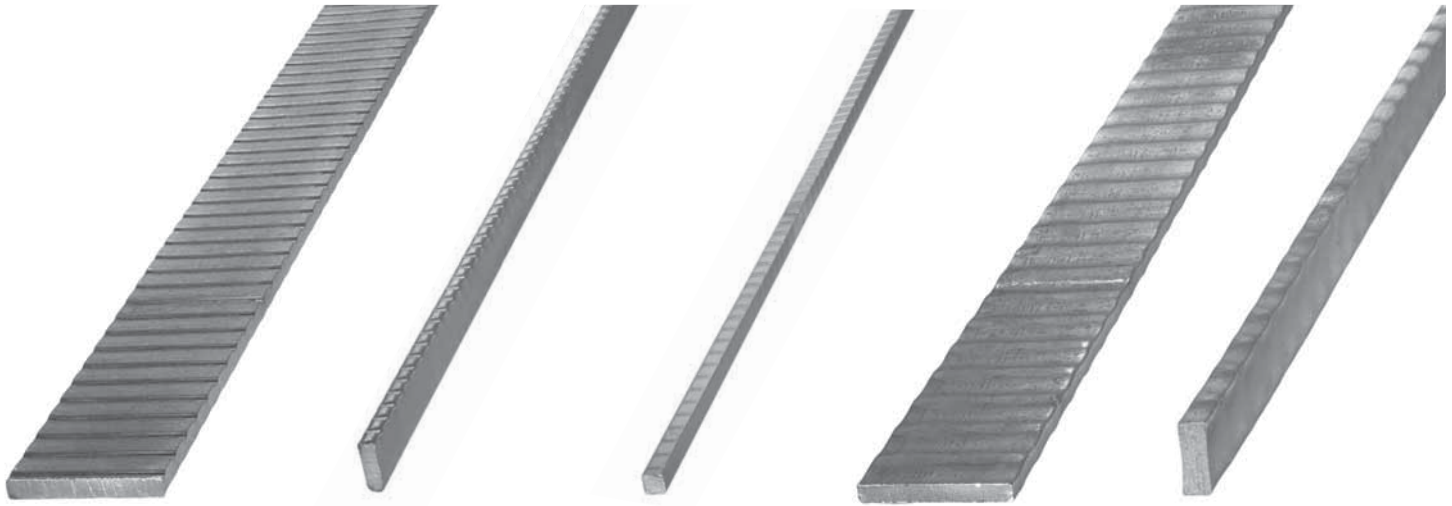

Piatto mod. scala battuto sopra e sotto / *Flat scala model beaten over and below (2 sides)*

H.3000 mm.	
Art. 12.088	≡ 30 X 8
Art. 12.089	≡ 40 X 8
Art. 12.090	≡ 40 X 10
Art. 12.091	≡ 50 X 10
Art. 12.091.01	≡ 60 X 8
H.6000 mm.	
Art. 12.092	≡ 30 X 8
Art. 12.093	≡ 40 X 8
Art. 12.094	≡ 40 X 10
Art. 12.095	≡ 50 X 10
Art. 12.095.01	≡ 60 X 8

Piatto mod. scala battuto sugli spessori / *Flat scala model beaten on the thicknesses (2 sides)*

H.3000 mm.	
Art. 12.095.02	≡ 10 X 5
Art. 12.095.03	≡ 12 X 6
Art. 12.095.04	≡ 14 X 6
Art. 12.095.05	≡ 16 X 6
Art. 12.095.06	≡ 20 X 6
Art. 12.095.30	≡ 16 X 8
H.6000 mm.	
Art. 12.095.07	≡ 14 X 6
Art. 12.095.08	≡ 16 X 6
Art. 12.095.09	≡ 20 X 6
Art. 12.095.31	≡ 16 X 8

Quadro mod. scala battuto sopra e sotto / *Square scala model beaten over and below (2 sides)*

H.3000 mm.	
Art. 12.095.10	□ 8

Piatto battuto sopra e sotto / *Flat bar beaten over and below (2 sides)*

H.3000 mm.	
Art. 12.095.11	≡ 60 X 8
H.6000 mm.	
Art. 12.095.12	≡ 60 X 8

Piatto battuto sugli spessori / *Flat bar beaten on the thickness (2 sides)*

H.3000 mm.	
Art. 12.095.13	≡ 25 X 10
Art. 12.095.14	≡ 30 X 10
H.6000 mm.	
Art. 12.095.15	≡ 25 X 10
Art. 12.095.16	≡ 30 X 10

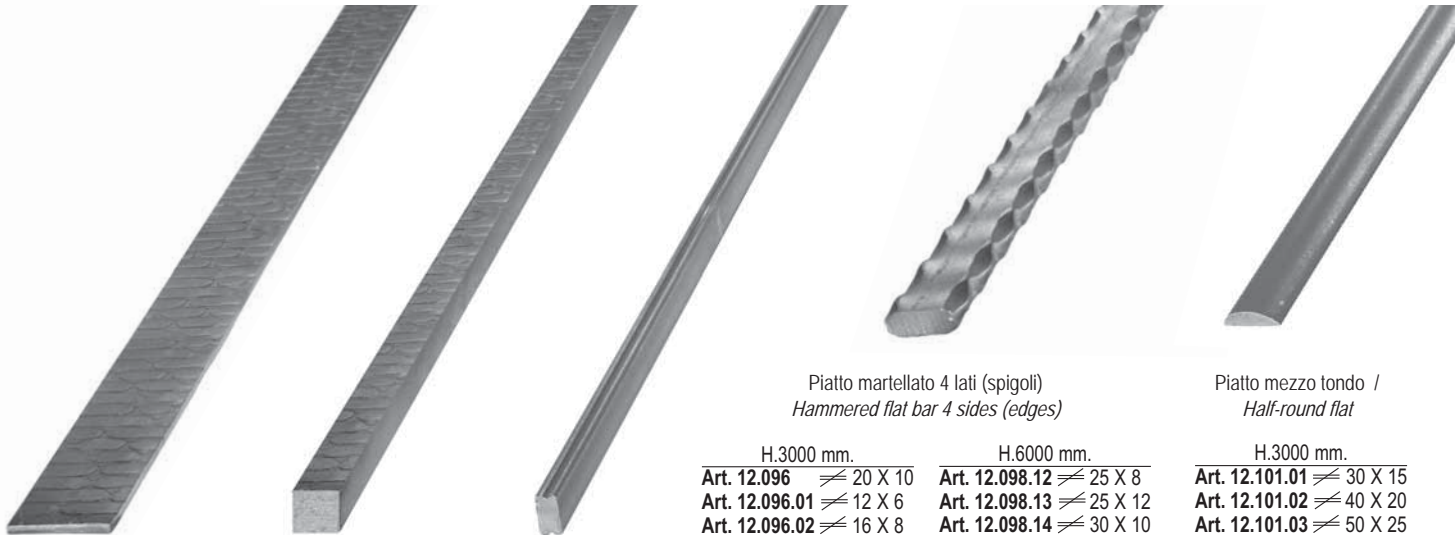

Piatto modello mattone battuto sopra e sotto / *Flat brick model beaten over and below (2 sides)*

H.3000 mm.	
Art. 12.095.17	≡ 20 X 4
Art. 12.095.18	≡ 25 X 4
Art. 12.095.19	≡ 25 X 6
Art. 12.095.20	≡ 25 X 8
Art. 12.095.21	≡ 30 X 4
Art. 12.095.22	≡ 30 X 6
Art. 12.095.23	≡ 30 X 8
Art. 12.095.24	≡ 40 X 4
Art. 12.095.25	≡ 40 X 6
Art. 12.095.26	≡ 40 X 8

Quadro modello mattone su 2 lati / *Square brick model beaten on 2 sides*

H.3000 mm.	
Art. 12.095.27	□ 12
Art. 12.095.32	□ 14

Piatto rigato sugli spessori / *Flat bar fluted on the thickness (2 sides)*

H.3000 mm.	
Art. 12.095.28	≡ 12 X 6
Art. 12.095.29	≡ 16 X 8

Piatto martellato 4 lati (spigoli) / *Hammered flat bar 4 sides (edges)*

H.3000 mm.		H.6000 mm.	
Art. 12.096	≡ 20 X 10	Art. 12.098.12	≡ 25 X 8
Art. 12.096.01	≡ 12 X 6	Art. 12.098.13	≡ 25 X 12
Art. 12.096.02	≡ 16 X 8	Art. 12.098.14	≡ 30 X 10
Art. 12.097	≡ 25 X 10	Art. 12.098.15	≡ 30 X 20
Art. 12.098	≡ 30 X 8	Art. 12.098.16	≡ 35 X 8
Art. 12.098.01	≡ 16 X 5	Art. 12.098.17	≡ 35 X 10
Art. 12.098.02	≡ 20 X 6	Art. 12.098.18	≡ 40 X 8
Art. 12.098.03	≡ 25 X 6	Art. 12.098.19	≡ 40 X 10
Art. 12.098.04	≡ 25 X 8	Art. 12.098.23	≡ 35 X 15
Art. 12.098.05	≡ 25 X 12	Art. 12.098.24	≡ 30 X 6
Art. 12.098.06	≡ 30 X 10	Art. 12.098.25	≡ 50 X 8
Art. 12.098.07	≡ 30 X 20	Art. 12.099	≡ 20 X 10
Art. 12.098.08	≡ 35 X 8	Art. 12.100	≡ 25 X 10
Art. 12.098.09	≡ 35 X 10	Art. 12.101	≡ 30 X 8
Art. 12.098.10	≡ 40 X 8	Art. 12.098.27	≡ 30 X 15
Art. 12.098.11	≡ 40 X 10		
Art. 12.098.20	≡ 35 X 15		
Art. 12.098.21	≡ 30 X 6		
Art. 12.098.22	≡ 50 X 8		
Art. 12.098.26	≡ 30 X 15		

Piatto mezzo tondo / *Half-round flat*

H.3000 mm.	
Art. 12.101.01	≡ 30 X 15
Art. 12.101.02	≡ 40 X 20
Art. 12.101.03	≡ 50 X 25
Art. 12.101.04	≡ 60 X 30
Art. 12.101.09	≡ 16 X 8
Art. 12.101.10	≡ 20 X 10
Art. 12.101.11	≡ 35 X 15
Art. 12.101.12	≡ 40 X 15
H.6000 mm.	
Art. 12.101.05	≡ 30 X 15
Art. 12.101.06	≡ 40 X 20
Art. 12.101.07	≡ 50 X 25
Art. 12.101.08	≡ 60 X 30
Art. 12.101.13	≡ 16 X 8
Art. 12.101.14	≡ 20 X 10
Art. 12.101.15	≡ 35 X 15
Art. 12.101.16	≡ 40 X 15
Art. 12.101.20	≡ 60 X 20

BARRE PER FASCETTE / COLLAR BARS



H.4000 mm.
Art. 12.108 \neq 14 X 4

H.3000 mm.

- Art. 12.108.01 \neq 25 X 8
- Art. 12.108.02 \neq 30 X 8
- Art. 12.108.05 \neq 40 X 8

H.6000 mm.

- Art. 12.108.03 \neq 25 X 8
- Art. 12.108.04 \neq 30 X 8
- Art. 12.108.06 \neq 40 X 8
- Art. 12.108.08 \neq 40 X 13



H.4000 mm.
Art. 12.109 \neq 18 X 6



H.4000 mm.
Art. 12.110 \neq 18 X 5



H.4000 mm.
Art. 12.111 \neq 14 X 4



H.3000 mm.
Art. 12.112 \neq 10 X 3

- Art. 12.113 \neq 12 X 3
- Art. 12.114 \neq 14 X 3
- Art. 12.115 \neq 16 X 4
- Art. 12.116 \neq 20 X 4

Non Prod. / Not Prod.



H.4000 mm.
Art. 12.117 \neq 11 X 3
Art. 12.118 \neq 14 X 4
Art. 12.119 \neq 16 X 5
Art. 12.120 \neq 21 X 6

NEW

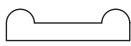

H. 3000 mm.
Art. 12.108.10 \neq 25 X 8
Art. 12.108.11 \neq 30 X 8

Barra Tacchettato/Scala / Collar bar Scala Model



H.3000 mm.
Art. 12.120.02 \neq 15 X 3



H.3000 mm.
Art. 12.120.03 \neq 20 X 4



\neq 14 X 4 mm.
Art. 12.122 2 \neq 12 X 6
Art. 12.123 2 \neq 12 X 6
+ 1 \square 12 X 12
Art. 12.124 2 \square 8 X 8



\neq 18 X 6 mm.
Art. 12.125 1 \square 20 X 20



\neq 14 X 4 mm.
Art. 12.126 2 \neq 12 X 6
Art. 12.127 2 \neq 12 X 6
+ 1 \square 12 X 12
Art. 12.128 2 \square 8 X 8
Art. 12.129 3 \square 8 X 8



\neq 18 X 5 mm.
Art. 12.130 2 \neq 12 X 6
+ 1 \square 12 X 12

Art. 12.130.01 1 \neq 12 X 6
+ 1 \square 12 X 12

Art. 12.130.02 1 \neq 14 X 6
+ 1 \square 14 X 14

Art. 12.130.03 2 \neq 14 X 6
+ 1 \square 14 X 14

Art. 12.130.04 1 \neq 16 X 6
+ 1 \square 16 X 16

Art. 12.130.05 2 \neq 16 X 6
+ 1 \square 16 X 16



\neq 14 X 4 mm.
Art. 12.131 2 \neq 20 X 6
Art. 12.132 3 \neq 20 X 4
Art. 12.133 3 \neq 20 X 6
Art. 12.134 2 \neq 12 X 6
+ 1 \square 12 X 12

Art. 12.134.01 1 \neq 12 X 6
+ 1 \square 12 X 12

Art. 12.134.02 1 \neq 14 X 6
+ 1 \square 14 X 14

Art. 12.134.03 2 \neq 14 X 6
+ 1 \square 14 X 14

Art. 12.134.04 1 \neq 16 X 6
+ 1 \square 16 X 16

Art. 12.134.05 2 \neq 16 X 6
+ 1 \square 16 X 16



Quadro martellato sui 4 spigoli / Hammered square on the 4 edges

H.3000 mm.	H.3000 mm.
Art. 12.135 ≡ 16 X 4	Art. 12.143 □ 6 X 6
Art. 12.136 ≡ 20 X 4	Art. 12.144 □ 8 X 8
Art. 12.137 ≡ 30 X 4	Art. 12.145 □ 10 X 10
Art. 12.138 ≡ 25 X 5	Art. 12.146 □ 12 X 12
H.6000 mm.	H.6000 mm.
Art. 12.139 ≡ 16 X 4	Art. 12.147 □ 14 X 14
Art. 12.140 ≡ 20 X 4	Art. 12.148 □ 16 X 16
Art. 12.141 ≡ 30 X 4	Art. 12.149 □ 18 X 18
Art. 12.142 ≡ 25 X 5	Art. 12.150 □ 20 X 20
	Art. 12.151 □ 25 X 25
	Art. 12.152 □ 30 X 30
	Art. 12.153 □ 35 X 35
	Art. 12.154 □ 40 X 40
	H.6000 mm.
	Art. 12.155 □ 6 X 6
	Art. 12.156 □ 8 X 8
	Art. 12.157 □ 10 X 10
	Art. 12.158 □ 12 X 12
	Art. 12.159 □ 14 X 14
	Art. 12.160 □ 16 X 16
	Art. 12.161 □ 18 X 18
	Art. 12.162 □ 20 X 20
	Art. 12.163 □ 25 X 25
	Art. 12.164 □ 30 X 30
	Art. 12.165 □ 35 X 35
	Art. 12.166 □ 40 X 40

c.

Mod. Liquirizia
Liquorice Model

H.3000 mm.

Art. 12.166.01 □ 12 X 12
Art. 12.166.02 □ 14 X 14
Art. 12.166.03 □ 16 X 16

Funi con Tondino

H.5700 mm.

Art. 12.167 Ø 16 4 tondini / 4 rods Ø 6mm.
Art. 12.168 Ø 20 4 tondini / 4 rods Ø 8mm.
Art. 12.169 Ø 25 4 tondini / 4 rods Ø 10mm.
Art. 12.170 Ø 30 4 tondini / 4 rods Ø 12mm.

Funi con Quadro

H.5700 mm.

Art. 12.171 □ 23 X 23
Art. 12.172 □ 28 X 28
Art. 12.173 □ 34 X 34
Art. 12.174 □ 39 X 39

Quadro Martellato
Hammered Square

H.3000 mm.

Art. 12.175 □ 12 X 12
Art. 12.176 □ 14 X 14
Art. 12.177 □ 16 X 16
Art. 12.178 □ 20 X 20
Art. 12.179 □ 25 X 25
Art. 12.180 □ 30 X 30
Art. 12.181 □ 40 X 40
Art. 12.181.01 □ 18 X 18
Art. 12.181.02 □ 35 X 35

H.6000 mm.

Art. 12.182 □ 12 X 12
Art. 12.183 □ 14 X 14
Art. 12.184 □ 16 X 16
Art. 12.185 □ 20 X 20
Art. 12.186 □ 25 X 25
Art. 12.187 □ 30 X 30
Art. 12.188 □ 40 X 40
Art. 12.188.01 □ 18 X 18
Art. 12.188.02 □ 35 X 35

Tondo Martellato
Hammered Round

H.3000 mm.

Art. 12.175.01 Ø 12
Art. 12.176.01 Ø 14
Art. 12.176.02 Ø 16
Art. 12.176.03 Ø 18
Art. 12.176.04 Ø 20
Art. 12.176.05 Ø 25
Art. 12.176.06 Ø 30
H.6000 mm.
Art. 12.182.01 Ø 12
Art. 12.183.01 Ø 14
Art. 12.183.02 Ø 16
Art. 12.183.03 Ø 18
Art. 12.183.04 Ø 20
Art. 12.183.05 Ø 25
Art. 12.183.06 Ø 30





Rigato e martellato
su 4 facce
*Hammered and Fluted
on 4 sides*

H.3000 mm.
Art. 12.189 12 X 12
Art. 12.190 14 X 14

H.6000 mm.
Art. 12.191 12 X 12
Art. 12.192 14 X 14



Barre in Spigolo
Edged Bar

H.3000 mm.
Art. 12.192.01 12 X 12
Art. 12.192.02 14 X 14
Art. 12.192.03 16 X 16
Art. 12.192.04 18 X 18
Art. 12.192.05 20 X 20

H.6000 mm.
Art. 12.192.06 12 X 12
Art. 12.192.07 14 X 14
Art. 12.192.08 16 X 16
Art. 12.192.09 18 X 18
Art. 12.192.10 20 X 20
Art. 12.192.11 25 X 25
Art. 12.192.12 30 X 30



Rigato 4 facce
Fluted 4 faces

H.3000 mm.
Art. 12.193 12 X 12
Art. 12.194 14 X 14
Art. 12.194.01 16 X 16

H.6000 mm.
Art. 12.195 12 X 12
Art. 12.196 14 X 14
Art. 12.194.02 16 X 16

Rigato 2 facce
Fluted 2 faces

H.3000 mm.
Art. 12.194.03 12
Art. 12.194.04 14
Art. 12.194.05 16

H.6000 mm.
Art. 12.194.06 12
Art. 12.194.07 14
Art. 12.194.08 16



Modello Corteccia
Bark Model

H.3000 mm.
Art. 12.196.01 Ø 14
Art. 12.196.02 Ø 16
Art. 12.196.03 Ø 20
Art. 12.196.04 Ø 22
Art. 12.196.09 Ø 18
Art. 12.196.10 Ø 25
Art. 12.196.11 Ø 30
Art. 12.196.15 Ø 12

H.6000 mm.
Art. 12.196.05 Ø 14
Art. 12.196.06 Ø 16
Art. 12.196.07 Ø 20
Art. 12.196.08 Ø 22
Art. 12.196.12 Ø 18
Art. 12.196.13 Ø 25
Art. 12.196.14 Ø 30
Art. 12.196.16 Ø 12



Modello Corteccia
Bark Model

H.3000 mm.
Art. 12.196.50 12
Art. 12.196.51 14
Art. 12.196.52 16

H.6000 mm.
Art. 12.196.61 12
Art. 12.196.62 14
Art. 12.196.63 16



Modello Scala
Scala Model

H.3000 mm.
Art. 12.197 12 X 12
Art. 12.198 14 X 14
Art. 12.199 16 X 16
Art. 12.200 18 X 18
Art. 12.201 20 X 20
Art. 12.202 25 X 25
Art. 12.203 30 X 30
Art. 12.204 40 X 40

H.6000 mm.
Art. 12.205 12 X 12
Art. 12.206 14 X 14
Art. 12.207 16 X 16
Art. 12.208 18 X 18
Art. 12.209 20 X 20
Art. 12.210 25 X 25
Art. 12.211 30 X 30
Art. 12.212 40 X 40



Piatto Modello Scala
Flat Scala Model

H.3000 mm.
Art. 12.204.01 30 X 20

H.6000 mm.
Art. 12.212.01 30 X 20



Quadro battuto 4 lati
Square Bars Hammered on 4 sides

H.3000 mm.
Art. 12.213 12 X 12
Art. 12.214 14 X 14
Art. 12.215 16 X 16
Art. 12.216 18 X 18
Art. 12.217 20 X 20
Art. 12.218 25 X 25
Art. 12.219 30 X 30
Art. 12.220 35 X 35
Art. 12.221 40 X 40

H.6000 mm.
Art. 12.222 12 X 12
Art. 12.223 14 X 14
Art. 12.224 16 X 16
Art. 12.225 18 X 18
Art. 12.226 20 X 20
Art. 12.227 25 X 25
Art. 12.228 30 X 30
Art. 12.229 35 X 35
Art. 12.230 40 X 40



Piatto battuto 2 lati
Flat Bars Hammered on 2 sides

H.3000 mm.
Art. 12.221.01 30 X 20

H.6000 mm.
Art. 12.228.01 30 X 20

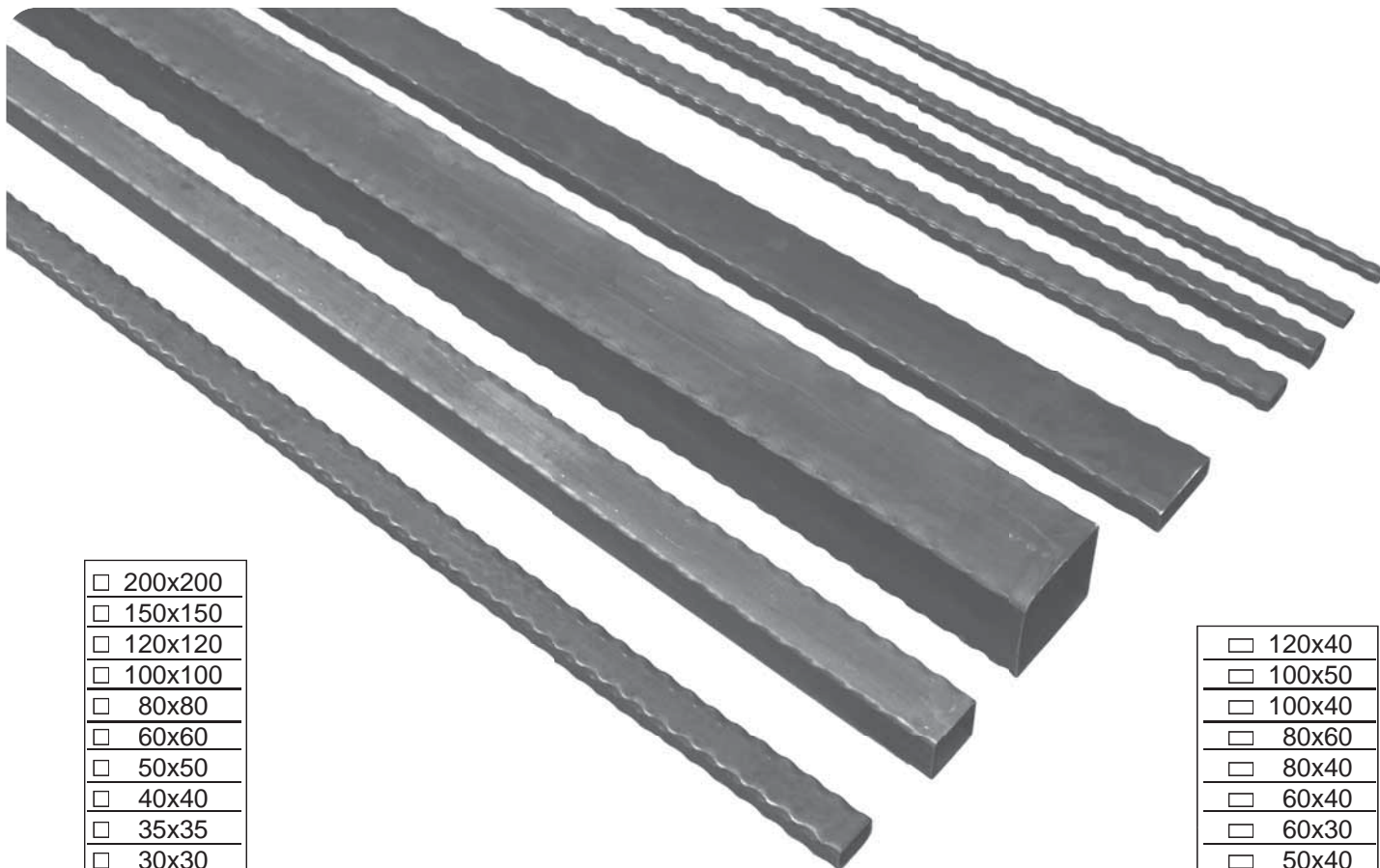
Tubo martellato / *Hammered Tube*

□ 200x200
□ 150x150
□ 120x120
□ 100x100
□ 80x80
□ 60x60
□ 50x50
□ 40x40
□ 35x35
□ 30x30
□ 25x25
□ 20x20
□ 15x15
□ 12x12



□ 120x40
□ 100x50
□ 100x40
□ 80x60
□ 80x40
□ 60x40
□ 60x30
□ 50x40
□ 50x30
□ 40x30
□ 40x20
□ 30x20

□ 200 X 200 X 4 mm.
Art. 12.230.07 H.3000 mm.
Art. 12.230.08 H.6000 mm.

□ 50 X 50 X 2,5 mm.
Art. 12.235 H.3000 mm.
Art. 12.236 H.6000 mm.

□ 120 X 40 X 3 mm.
Art. 12.244.08 H.3000 mm.
Art. 12.244.11 H.6000 mm.

□ 60 X 30 X 2,5 mm.
Art. 12.246.01 H.3000 mm.
Art. 12.246.02 H.6000 mm.

□ 150 X 150 X 4 mm.
Art. 12.230.05 H.3000 mm.
Art. 12.230.06 H.6000 mm.

□ 40 X 40 X 2,5 mm.
Art. 12.237 H.3000 mm.
Art. 12.238 H.6000 mm.

□ 100 X 50 X 3 mm.
Art. 12.244.07 H.3000 mm.
Art. 12.244.10 H.6000 mm.

□ 50 X 40 X 2,5 mm.
Art. 12.247 H.3000 mm.
Art. 12.248 H.6000 mm.

□ 120 X 120 X 3 mm.
Art. 12.230.01 H.3000 mm.
Art. 12.230.02 H.6000 mm.

□ 35 X 35 X 3 mm.
Art. 12.238.01 H.3000 mm.
Art. 12.238.02 H.6000 mm.

□ 100 X 40 X 3 mm.
Art. 12.244.03 H.3000 mm.
Art. 12.244.04 H.6000 mm.

□ 50 X 30 X 2,5 mm.
Art. 12.249 H.3000 mm.
Art. 12.250 H.6000 mm.

□ 100 X 100 X 3 mm.
Art. 12.230.03 H.3000 mm.
Art. 12.230.04 H.6000 mm.

□ 30 X 30 X 2,5 mm.
Art. 12.239 H.3000 mm.
Art. 12.240 H.6000 mm.

□ 80 X 60 X 3 mm.
Art. 12.244.09 H.3000 mm.
Art. 12.244.12 H.6000 mm.

□ 40 X 30 X 2,5 mm.
Art. 12.250.01 H.3000 mm.
Art. 12.250.02 H.6000 mm.

□ 80 X 80 X 2,5 mm.
Art. 12.231 H.3000 mm.
Art. 12.232 H.6000 mm.

□ 25 X 25 X 2,5 mm.
Art. 12.241 H.3000 mm.
Art. 12.242 H.6000 mm.

□ 80 X 40 X 2,5 mm.
Art. 12.244.05 H.3000 mm.
Art. 12.244.06 H.6000 mm.

□ 40 X 20 X 2 mm.
Art. 12.251 H.3000 mm.
Art. 12.252 H.6000 mm.

□ 60 X 60 X 2,5 mm.
Art. 12.233 H.3000 mm.
Art. 12.234 H.6000 mm.

H.3000 mm.
Art. 12.243 □ 20 X 20 X 2
Art. 12.244.01 □ 12 X 12 X 1,5
Art. 12.244.02 □ 15 X 15 X 1,5
H.6000 mm.
Art. 12.244 □ 20 X 20 X 2

□ 60 X 40 X 2,5 mm.
Art. 12.245 H.3000 mm.
Art. 12.246 H.6000 mm.

□ 30 X 20 X 2 mm.
Art. 12.253 H.3000 mm.
Art. 12.254 H.6000 mm.

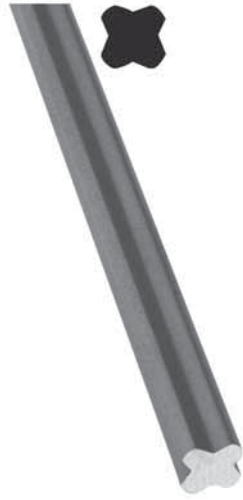
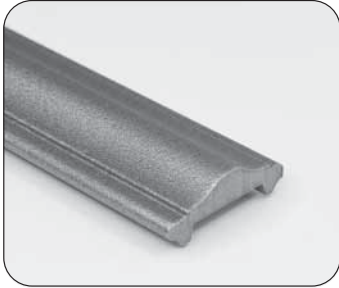
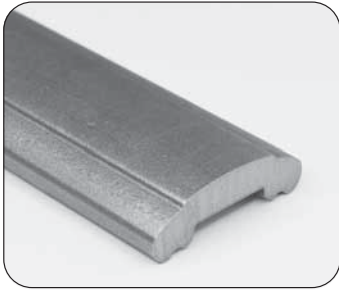

H.3000 mm.
Art. 12.261 □ 16 mm



H.3000 mm.
Art. 12.262 □ 15 mm



H.4000 mm.
Art. 12.263 ≡ 20 X 12 mm

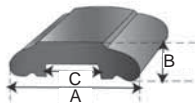

H.3000 mm
Art. 12.270 ≡ A = 55 / B = 17 / C = 25 mm
Art. 12.270.01 ≡ A = 45 / B = 15 / C = 22 mm

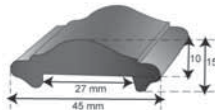

H.3000 mm
Art. 12.271 ≡ 45 X 15

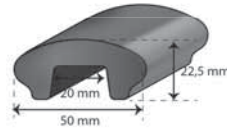

H.6000 mm
Art. 12.272
≡ A = 50 / B = 22,5 / C = 20 mm

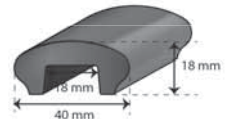

H.6000 mm
Art. 12.272.01
≡ A = 40 / B = 18 / C = 18 mm

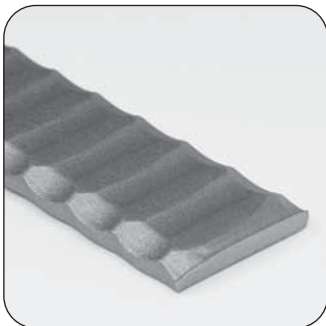

Martellato / Hammered
H.3000 mm.
Art. 12.273 ≡ 40 X 8 mm
H.6000 mm.
Art. 12.273.01 ≡ 40 X 8 mm



Lavorato / Worked
H.3000 mm.
Art.12.274 ≡ 40 x 8 mm



PARTENZone



Stop agli allineamenti e alla saldatura tra partenza e corrimano.

Ecco la prima rampa della tua scala in un unico pezzo già pronta per l'installazione e facilmente adattabile alle tue esigenze con un semplice taglio.



PARTENZone



Stop alignments and welding between start and handrails.

Here is the first flight of your staircase in one piece ready for installation that can easily be adapted to your needs with a simple cut.

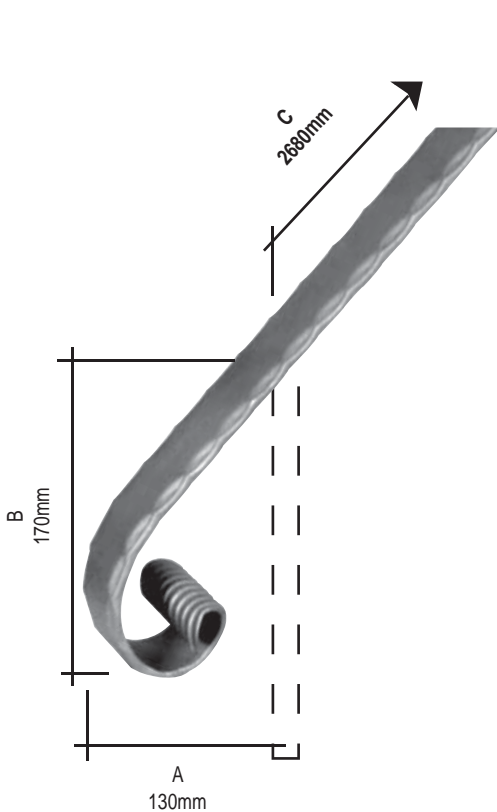
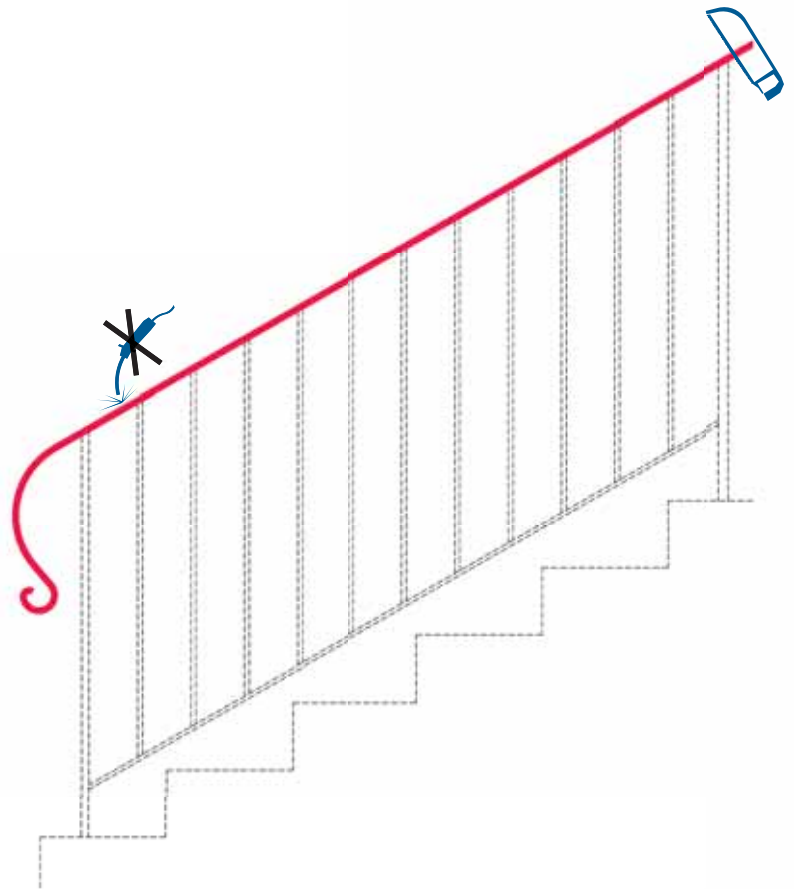

Martellato / Hammered
Art.12.P1.013 \neq 40 x 8 mm

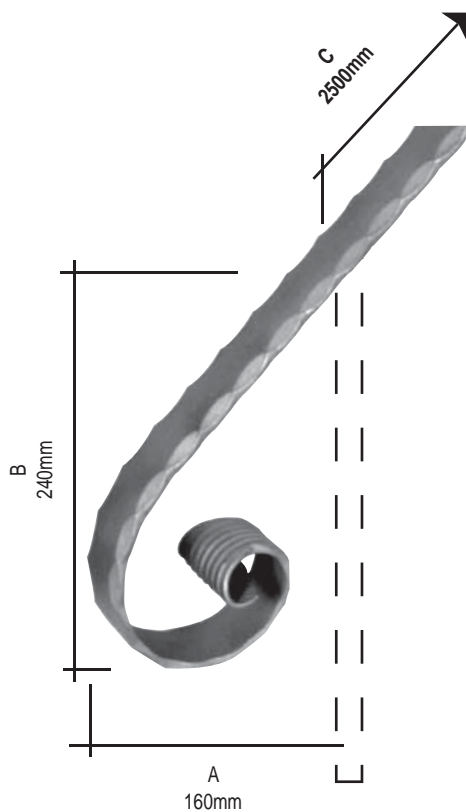

Martellato / Hammered
Art.12.P1.015 \neq 40 x 8 mm

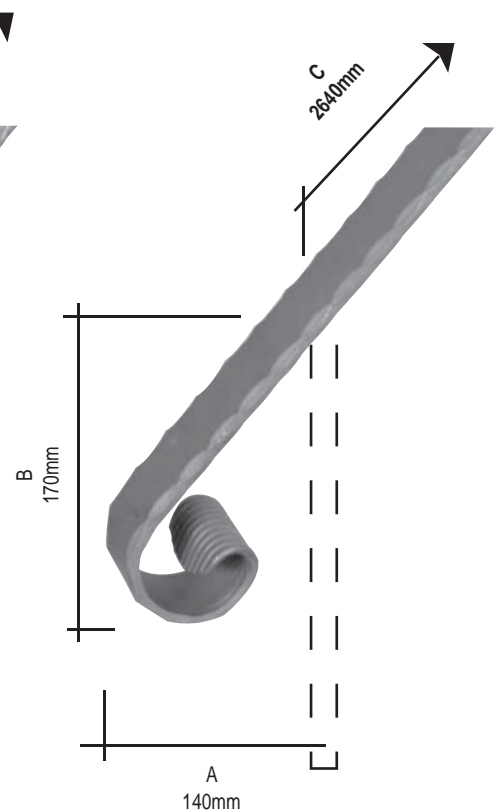

Martellato / Hammered
Art.12.P1.017 \neq 40 x 8 mm
Art.12.P1.018 \neq 50 x 10 mm

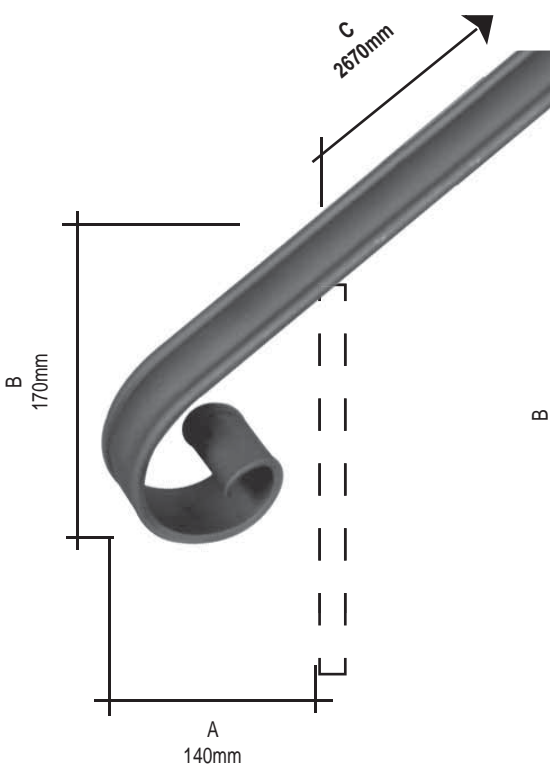

Art.12.P1.056 40 x 8 mm

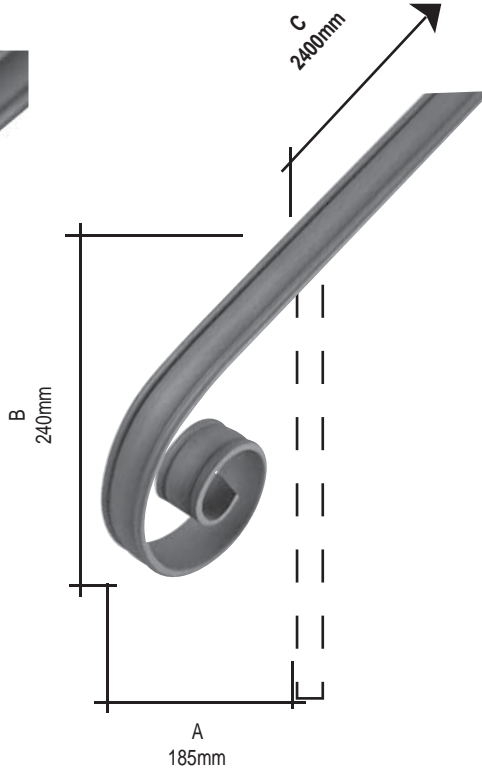

Art.12.P1.056.01 40 x 8 mm

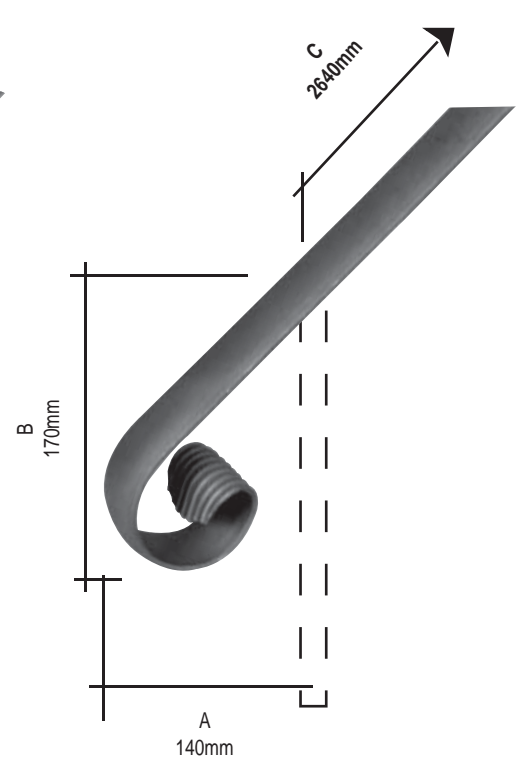

Art.12.P1.072 40 x 8 mm
Art.12.P1.073 40 x 10 mm
Art.12.P1.074 40 x 12 mm
Art.12.P1.075 50 x 10 mm

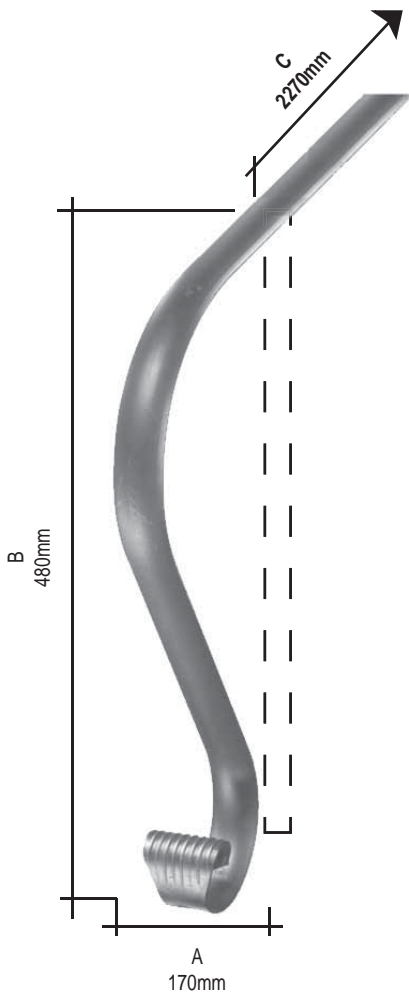

Art.12.P1.078.01 40 x 10 mm
Art.12.P1.079 40 x 12 mm

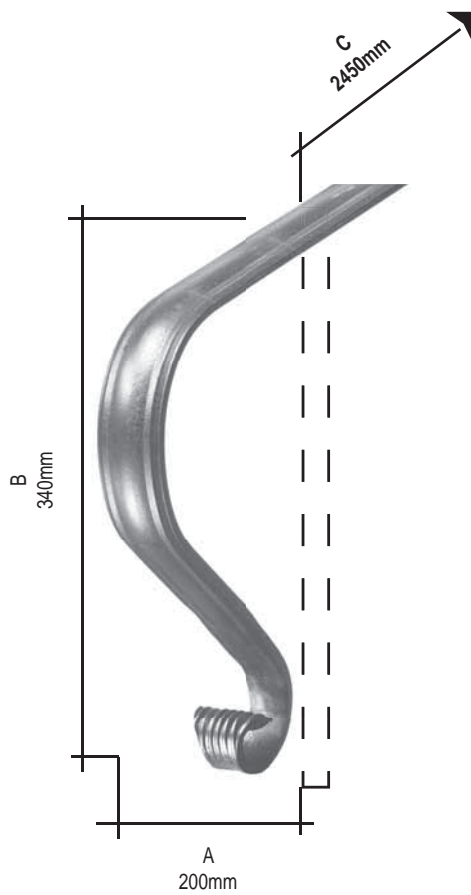

Art.12.P1.086 50 x 14 mm
Art.12.P1.086.01 40 x 12 mm
Art.12.P1.086.02 45 x 12 mm

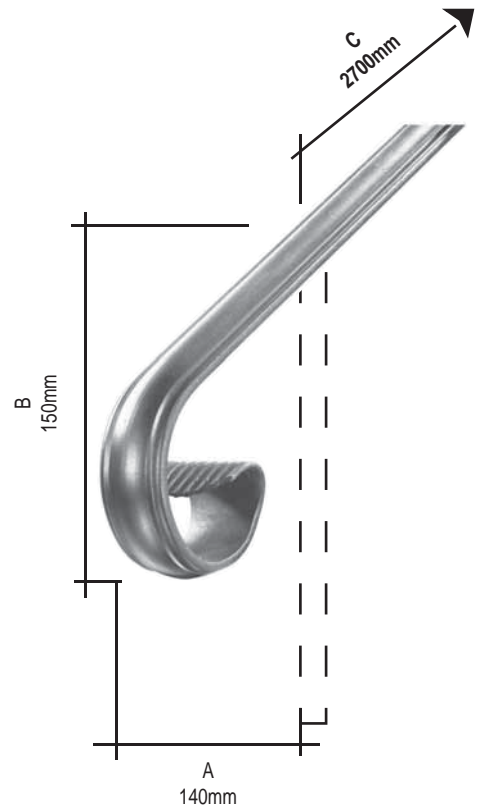

Art.12.P1.086.12 50 x 14 mm
Art.12.P1.086.13 40 x 12 mm
Art.12.P1.086.14 45 x 12 mm
Art.12.P1.086.15 60 x 16 mm

Tutte le parti di questo catalogo - foto comprese - sono di proprietà Euro-Fer. La riproduzione, anche parziale, è vietata in ogni forma e con ogni mezzo. / Every part of this catalogue - photos included - is Euro-Fer's property. All forms of copying are strictly prohibited.

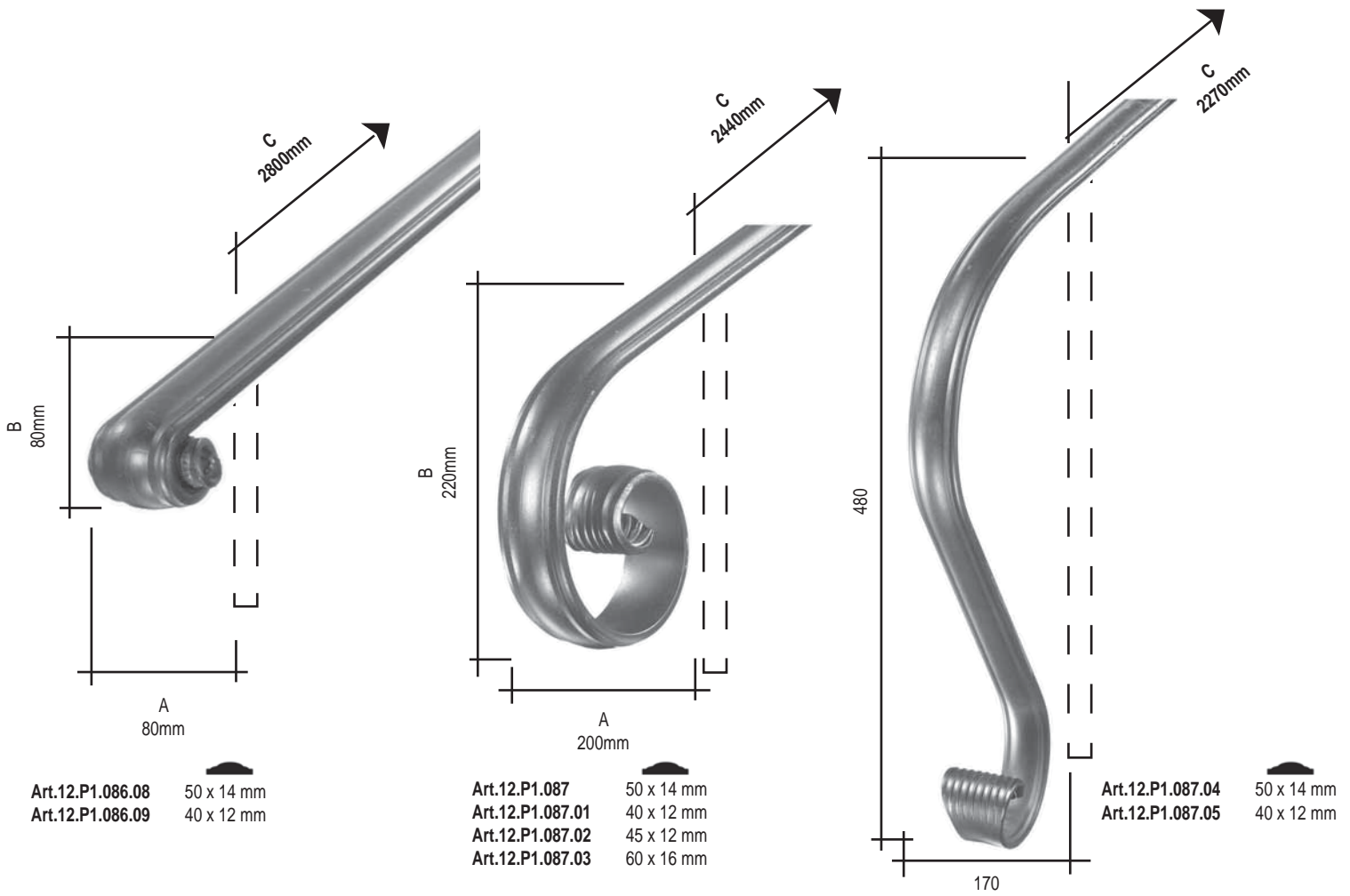

			C
<input type="checkbox"/>	Art.12.P1.013	40 x 8 mm	2680 mm
<input type="checkbox"/>	Art.12.P1.015	40 x 8 mm	2500 mm
<input type="checkbox"/>	Art.12.P1.017	40 x 8 mm	2640 mm
<input type="checkbox"/>	Art.12.P1.018	50 x 10 mm	2640 mm
<input type="checkbox"/>	Art.12.P1.056	40 x 8 mm	2670 mm
<input type="checkbox"/>	Art.12.P1.056.01	40 x 8 mm	2400 mm
<input type="checkbox"/>	Art.12.P1.072	40 x 8 mm	2640 mm
<input type="checkbox"/>	Art.12.P1.073	40 x 10 mm	2640 mm
<input type="checkbox"/>	Art.12.P1.074	40 x 12 mm	2640 mm
<input type="checkbox"/>	Art.12.P1.075	50 x 10 mm	2640 mm
<input type="checkbox"/>	Art.12.P1.078.01	40 x 10 mm	2270 mm
<input type="checkbox"/>	Art.12.P1.079	40 x 12 mm	2270 mm
<input type="checkbox"/>	Art.12.P1.086	50 x 14 mm	2450 mm
<input type="checkbox"/>	Art.12.P1.086.01	40 x 12 mm	2450 mm
<input type="checkbox"/>	Art.12.P1.086.02	45 x 12 mm	2450 mm
<input type="checkbox"/>	Art.12.P1.086.08	50 x 14 mm	2800 mm
<input type="checkbox"/>	Art.12.P1.086.09	40 x 12 mm	2800 mm
<input type="checkbox"/>	Art.12.P1.086.12	50 x 14 mm	2700 mm
<input type="checkbox"/>	Art.12.P1.086.13	40 x 12 mm	2700 mm
<input type="checkbox"/>	Art.12.P1.086.14	45 x 12 mm	2700 mm
<input type="checkbox"/>	Art.12.P1.086.15	60 x 16 mm	2700 mm
<input type="checkbox"/>	Art.12.P1.087	50 x 14 mm	2440 mm
<input type="checkbox"/>	Art.12.P1.087.01	40 x 12 mm	2440 mm
<input type="checkbox"/>	Art.12.P1.087.02	45 x 12 mm	2440 mm
<input type="checkbox"/>	Art.12.P1.087.03	60 x 16 mm	2440 mm
<input type="checkbox"/>	Art.12.P1.087.04	50 x 14 mm	2270 mm
<input type="checkbox"/>	Art.12.P1.087.05	40 x 12 mm	2270 mm

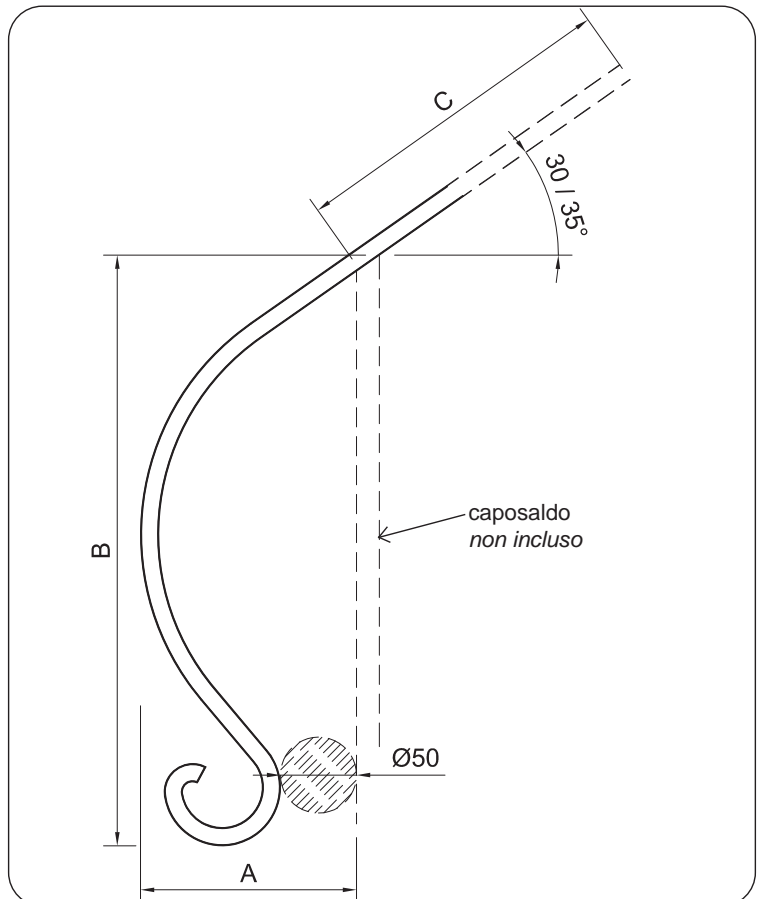





TONDO
MARTELLATO
HAMMERED
ROUND



RIGATO +
MARTELLATO
HAMMERED
FLUTED



QUADRO
BATTUTO
4 LATI
SQUARE BARS
HAMMERED
ON 4 SIDES



MODELLO
CORTECCIA
BARK MODEL

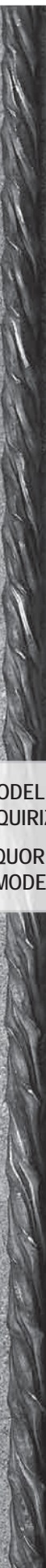

MODELLO
LIQUIRIZIA
LIQUORICE
MODEL



RIGATO
4 FACCE
FLUTED
4 FACES



H.200 mm.
Art. 13.001 12
Art. 13.002 14
Art. 13.003 16



Fiamma Grande / Big Flame
Liscio / Smooth
H.250X L.48 mm
Art. 13.001.02 12
H.250X L.51 mm
Art. 13.001.03 14
H.250X L.54 mm
Art. 13.001.04 16



Martellato / Hammered
H.200 mm.
Art. 13.003.01 12
Art. 13.003.02 14
Art. 13.003.03 16



Tondo / Round
H.200 mm.
Art. 13.003.04 12
Art. 13.003.05 14
Art. 13.003.06 16



Fiamma Grande / Big Flame
Tondo / Round
H.250X L.48 mm
Art. 13.003.07 12
H.250X L.51 mm
Art. 13.003.08 14
H.250X L.54 mm
Art. 13.003.09 16



Fiamma Grande / Big Flame
Martellato / Hammered
H.250X L.48 mm
Art. 13.003.10 12
H.250X L.51 mm
Art. 13.003.11 14
H.250X L.54 mm
Art. 13.003.12 16



H.200 mm.
Art. 13.004 12
Art. 13.005 14
Art. 13.006 16



Martellato / Hammered
H.200 mm.
Art. 13.006.01 12
Art. 13.006.02 14
Art. 13.006.03 16



Tondo / Round
H.200 mm.
Art. 13.006.04 12
Art. 13.006.05 14
Art. 13.006.06 16



H.250 mm.
Art. 13.007 12
Art. 13.008 14
Art. 13.009 16



Martellato / Hammered
H.250 mm.
Art. 13.009.01 12
Art. 13.009.02 14
Art. 13.009.03 16



Tondo / Round
H.250 mm.
Art. 13.009.04 14
Art. 13.009.05 16



H.200 mm.
Art. 13.010 12
Art. 13.011 14
Art. 13.012 16



Martellato / Hammered
H.200 mm.
Art. 13.012.01 12
Art. 13.012.02 14
Art. 13.012.03 16



Tondo / Round
H.200 mm.
Art. 13.012.04 12
Art. 13.012.05 14
Art. 13.012.06 16



Fiamma grande / Big flame

Liscio / Smooth
H.250X L.48 mm
Art. 13.012.20 12
H.250X L.51 mm
Art. 13.012.21 14
H.250X L.54 mm
Art. 13.012.22 16
H.250X L.48 mm
Art. 13.012.23 12
H.250X L.51 mm
Art. 13.012.24 14
H.250X L.54 mm
Art. 13.012.25 16



H.200 mm.
Art. 13.013 12
Art. 13.014 14
Art. 13.015 16



Martellato / Hammered
H.200 mm.
Art. 13.015.01 12
Art. 13.015.02 14
Art. 13.015.03 16



Tondo / Round
H.200 mm.
Art. 13.015.04 12
Art. 13.015.05 14
Art. 13.015.06 16



H.150 mm.
Art. 13.016 12
Art. 13.017 14
Art. 13.018 16



Fiamma grande / Big flame

Tondo / Round
H.250 mm.
Art. 13.015.20 12



Martellato / Hammered
H.150 mm.
Art. 13.018.01 12
Art. 13.018.02 14
Art. 13.018.03 16



Tondo / Round
H.150 mm.
Art. 13.018.04 12
Art. 13.018.05 14
Art. 13.018.06 16



H.200 mm.
Art. 13.018.07 12
Art. 13.018.08 14
Art. 13.018.09 16



Martellato / Hammered
H.200 mm.
Art. 13.018.10 12
Art. 13.018.11 14
Art. 13.018.12 16



H.200 mm.
Art. 13.018.13 12
Art. 13.018.14 14
Art. 13.018.15 16



Martellato / Hammered
H.200 mm.
Art. 13.018.16 12
Art. 13.018.17 14
Art. 13.018.18 16



Modello Catania / Catania model



H.200 mm.
Art. 13.018.19 12
Art. 13.018.20 14
Art. 13.018.21 16

Martellato / Hammered
H.200 mm.
Art. 13.018.22 12
Art. 13.018.23 14
Art. 13.018.24 16

H.200 mm.
Art. 13.019 12
Art. 13.020 14
Art. 13.021 16

H.200 mm.
Art. 13.022 12
Art. 13.023 14
Art. 13.024 16

Liscio / Smooth
H.200 mm
Art. 13.024.50 12
Art. 13.024.51 14
Art. 13.024.52 16
Art. 13.024.53 18
Art. 13.024.54 20

Liscio / Smooth
H.200 mm
Art. 13.024.55 12
Art. 13.024.56 14
Art. 13.024.57 16
Art. 13.024.58 18
Art. 13.024.59 20

Liscio / Smooth
H.200 mm
Art. 13.024.100 12
Art. 13.024.101 14

Liscio / Smooth
H.200 mm
Art. 13.024.110 12
Art. 13.024.111 14

Liscio / Smooth
H.200 mm

Liscio / Smooth
H.200 mm

Sfera / Sphere Ø20 Art. 13.024.145 <input type="checkbox"/> 12	Sfera / Sphere Ø35 Art. 13.024.159 <input type="checkbox"/> 12 Art. 13.024.160 <input type="checkbox"/> 16
Sfera / Sphere Ø25 Art. 13.024.150 <input type="checkbox"/> 12 Art. 13.024.151 <input type="checkbox"/> 14 Art. 13.024.153 <input type="checkbox"/> 12	Sfera / Sphere Ø25 / Forged Sphere Ø 25 Art. 13.024.161 <input type="checkbox"/> 12 Art. 13.024.162 <input type="checkbox"/> 14
Sfera / Sphere Ø30 Art. 13.024.156 <input type="checkbox"/> 12 Art. 13.024.157 <input type="checkbox"/> 14	Sfera Forgiata Ø 25 / Forged Sphere Ø 25 Art. 13.024.170 <input type="checkbox"/> 12



PALLINE GRANDI / LARGE BALLS

H.200 mm. Art. 13.025 <input type="checkbox"/> 12 Art. 13.026 <input type="checkbox"/> 14 Art. 13.027 <input type="checkbox"/> 16 Art. 13.027.01 <input type="checkbox"/> 18	Martellato / Hammered H.200 mm. Art. 13.027.02 <input type="checkbox"/> 12 Art. 13.027.03 <input type="checkbox"/> 14 Art. 13.027.04 <input type="checkbox"/> 16 Art. 13.027.05 <input type="checkbox"/> 18	Tondo / Round H.200 mm. Art. 13.027.06 <input type="checkbox"/> 12 Art. 13.027.07 <input type="checkbox"/> 14 Art. 13.027.08 <input type="checkbox"/> 16 Art. 13.027.09 <input type="checkbox"/> 18 Art. 13.027.10 <input type="checkbox"/> 20
--	--	--

Liscio / Smooth
H.250 mm
Art. 13.027.40 12
Art. 13.027.41 14

Liscio / Smooth
H.250 mm
Art. 13.027.43 12
Art. 13.027.44 14
Art. 13.027.45 16

Liscio / Smooth
H.200 mm
Art. 13.027.50 12
Art. 13.027.51 14
Art. 13.027.52 16

Liscio / Smooth
H.200 mm
Art. 13.027.55 12
Art. 13.027.56 14
Art. 13.027.57 16

Punta a piramide Pyramid Point H.200 mm. Art. 13.028 <input type="checkbox"/> 12 Art. 13.029 <input type="checkbox"/> 14 Art. 13.030 <input type="checkbox"/> 16 Art. 13.030.01 <input type="checkbox"/> 18 Art. 13.030.02 <input type="checkbox"/> 20	Punta a matita → Pencil Point Martellato / Hammered H.200 mm. Art. 13.030.03 <input type="checkbox"/> 12 Art. 13.030.04 <input type="checkbox"/> 14 Art. 13.030.05 <input type="checkbox"/> 16 Art. 13.030.06 <input type="checkbox"/> 18 Art. 13.030.07 <input type="checkbox"/> 20	Tondo / Round H.200 mm. Art. 13.030.08 <input type="checkbox"/> 12 Art. 13.030.09 <input type="checkbox"/> 14 Art. 13.030.10 <input type="checkbox"/> 16 Art. 13.030.11 <input type="checkbox"/> 18 Art. 13.030.12 <input type="checkbox"/> 20
---	--	--

H.230 mm. Art. 13.030.13 <input type="checkbox"/> 12 Art. 13.030.14 <input type="checkbox"/> 14 Art. 13.030.15 <input type="checkbox"/> 16	Martellato / Hammered H.230 mm. Art. 13.030.16 <input type="checkbox"/> 12 Art. 13.030.17 <input type="checkbox"/> 14 Art. 13.030.18 <input type="checkbox"/> 16	Tondo / Round H.230 mm. Art. 13.030.19 <input type="checkbox"/> 12 Art. 13.030.20 <input type="checkbox"/> 14 Art. 13.030.21 <input type="checkbox"/> 16
---	--	--

H.230 mm.
Art. 13.031 14

H.250 mm.
Art. 13.031.01 12
Art. 13.031.02 16
Art. 13.031.03 12 **NEW**
Art. 13.031.04 14
Art. 13.031.05 16

NEW

H.300 mm.
Art. 13.031.50 12
Art. 13.031.51 14
Art. 13.031.52 16
Art. 13.031.53 12
Art. 13.031.54 14
Art. 13.031.55 16

Pallina Grande / Large Ball
H.200 mm.
Art. 13.031.70 12
Art. 13.031.71 14 **NEW**
Art. 13.031.72 16

H.230 mm.
Art. 13.032 14

H.1400 mm.
Art. 13.031.73 14 **NEW**









H.1700 mm.
Art. 13.031.74 14 **NEW**









L.75 mm.
Art. 13.032.04 16 H.290
Art. 13.032.06 12 H.270
Art. 13.032.07 14 H.280
Art. 13.032.08 18 H.310









L.75 mm.
Art. 13.032.09 12 H.270
Art. 13.032.10 14 H.280
Art. 13.032.11 16 H.290
Art. 13.032.12 18 H.310







Lancia forgiata a caldo / Hot forged spear

Tutte le parti di questo catalogo - foto comprese - sono di proprietà Euro-Fer. La riproduzione, anche parziale, è vietata in ogni forma e con ogni mezzo. / Every part of this catalogue - photos included - is Euro-Fer's property. All forms of copying are strictly prohibited.

					PALLINE GRANDI / LARGE BALLS		
			NEW	NEW			
H.230 mm.	Martellato / Hammered H.230 mm.	Tondo / Round H.230 mm.	H.270 mm.	H.300 mm.	H.230 mm.	Martellato / Hammered H.230 mm.	Tondo / Round H.230 mm.
Art. 13.033 □ 14 Art. 13.033.01 □ 16 Art. 13.033.02 □ 12	Art. 13.033.03 □ 12 Art. 13.033.04 □ 14 Art. 13.033.05 □ 16	Art. 13.033.06 ∅ 12 Art. 13.033.07 ∅ 14 Art. 13.033.08 ∅ 16	Art. 13.033.10 □ 12 Art. 13.033.11 □ 14 Art. 13.033.12 □ 16 Art. 13.033.13 ∅ 12 Art. 13.033.14 ∅ 14 Art. 13.033.15 ∅ 16	Art. 13.033.50 □ 12 Art. 13.033.51 □ 14 Art. 13.033.52 □ 16 Art. 13.033.53 ∅ 12 Art. 13.033.54 ∅ 14 Art. 13.033.55 ∅ 16	Art. 13.034 □ 14 Art. 13.034.01 □ 16 Art. 13.034.02 □ 12	Art. 13.034.03 □ 12 Art. 13.034.04 □ 14 Art. 13.034.05 □ 16	Art. 13.034.06 ∅ 12 Art. 13.034.07 ∅ 14 Art. 13.034.08 ∅ 16

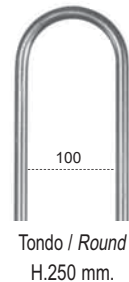
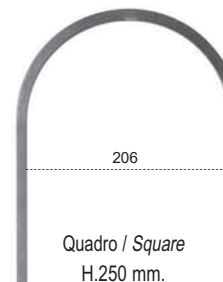
PALLINE GRANDI / LARGE BALLS					PALLINE GRANDI / LARGE BALLS			
								
	H.230 mm.	H.180 mm.	Martellato / Hammered H.180 mm.	Tondo / Round H.180 mm.	H.230 mm.	Martellato / Hammered H.230 mm.	Tondo / Round H.230 mm.	H.230 mm.
	Art. 13.034.50 □ 12 Art. 13.034.49 □ 16 Art. 13.035 □ 14 Art. 13.034.46 ∅ 12 Art. 13.034.47 ∅ 14 Art. 13.034.48 ∅ 16	Art. 13.035.01 □ 12 Art. 13.035.02 □ 14 Art. 13.035.03 □ 16	Art. 13.035.04 □ 12 Art. 13.035.05 □ 14 Art. 13.035.06 □ 16	Art. 13.035.07 ∅ 12 Art. 13.035.08 ∅ 14 Art. 13.035.09 ∅ 16	Art. 13.035.10 □ 12 Art. 13.035.11 □ 14 Art. 13.035.12 □ 16 Art. 13.035.13 □ 18	Art. 13.035.14 □ 12 Art. 13.035.15 □ 14 Art. 13.035.16 □ 16 Art. 13.035.17 □ 18	Art. 13.035.19 ∅ 14 Art. 13.035.20 ∅ 16 Art. 13.035.21 ∅ 18	Art. 13.035.22 □ 12 Art. 13.035.23 □ 14 Art. 13.035.24 □ 16 Art. 13.035.25 □ 18

							
H.250 mm.	Martellato / Hammered H.250 mm.	Tondo / Round H.250 mm.	Fascetta inserita a caldo Hot-inserted clip H.250 mm.	Fascetta inserita a caldo Hot-inserted clip Martellato / Hammered H.250 mm.	Fascetta inserita a caldo Hot-inserted clip Tondo / Round H.250 mm.	H.280 mm.	Martellato / Hammered H.280 mm.
Art. 13.035.26 □ 14 Art. 13.035.27 □ 16	Art. 13.035.28 □ 14 Art. 13.035.29 □ 16	Art. 13.035.30 ∅ 14 Art. 13.035.31 ∅ 16	Art. 13.035.32 □ 14 Art. 13.035.33 □ 16	Art. 13.035.34 □ 14 Art. 13.035.35 □ 16	Art. 13.035.36 ∅ 14 Art. 13.035.37 ∅ 16	Art. 13.035.38 □ 14 Art. 13.035.39 □ 16 Art. 13.035.40 □ 18	Art. 13.035.41 □ 14 Art. 13.035.42 □ 16 Art. 13.035.43 □ 18

				PALLINE PICCOLE / SMALL BALLS		
						
Tondo / Round H.280 mm.	Tondo Lavorato Worked Round Bar H.280 mm.	Tondo / Round H.250 mm.	Quadro / Square H.250 mm.	H.200 mm.	Martellato / Hammered H.200 mm.	Tondo / Round H.200 mm.
Art. 13.035.44 ∅ 14 Art. 13.035.45 ∅ 16 Art. 13.035.46 ∅ 18	Art. 13.035.47 ∅ 14 Art. 13.035.48 ∅ 16 Art. 13.035.49 ∅ 18	Art. 13.035.50 ∅ 12 Art. 13.035.51 ∅ 14 Quadro / Square H.250 mm. Art. 13.035.52 □ 12 Art. 13.035.53 □ 14	Art. 13.035.54 □ 12 Art. 13.035.55 □ 14 Tondo / Round H.250 mm. Art. 13.035.56 ∅ 12 Art. 13.035.57 ∅ 14	Art. 13.035.58 □ 12 Art. 13.035.59 □ 14 Art. 13.035.60 □ 16 Art. 13.035.61 □ 18 Art. 13.035.62 □ 20	Art. 13.035.63 □ 12 Art. 13.035.64 □ 14 Art. 13.035.65 □ 16 Art. 13.035.66 □ 18 Art. 13.035.67 □ 20	Art. 13.035.68 ∅ 12 Art. 13.035.69 ∅ 14 Art. 13.035.70 ∅ 16 Art. 13.035.71 ∅ 18

Tutte le parti di questo catalogo - foto comprese - sono di proprietà Euro-Fer. La riproduzione, anche parziale, è vietata in ogni forma e con ogni mezzo. / Every part of this catalogue - photos included - is Euro-Fer's property. All forms of copying are strictly prohibited.



Pallina piccola / *Small ball*
Liscio / *Smooth*
H.200 mm
Art. 13.035.80 □ 12
Art. 13.035.81 □ 14
Art. 13.035.82 □ 16



Pallina piccola / *Small ball*
Martellato / *Hammered*
H.200 mm
Art. 13.035.85 □ 12
Art. 13.035.86 □ 14
Art. 13.035.87 □ 16

Modello mezza luna / *Half moon model*



Liscio / *Smooth*
H. 190 X L.120 mm
Art. 13.035.100
2 x ≠ 16 X 8 mm
Art. 13.035.101
2 x ≠ 12 X 6 mm



Liscio / *Smooth*
H. 210 X L.130 mm
Art. 13.035.110
2 x ≠ 16 X 8 mm
Art. 13.035.111
2 x ≠ 12 X 6 mm



Schiacciata sullo spigolo / *Ornament on the edge*
H.200 mm
Art. 13.035.140 □ 12
Art. 13.035.141 □ 14
Art. 13.035.142 □ 16
Liscio / *Smooth*



Martellato / *Hammered*
H.200 mm
Art. 13.035.150 □ 12
Art. 13.035.151 □ 14
Art. 13.035.152 □ 16



Liscio / *Smooth*
H.200 mm
Art. 13.035.153 □ 12
Art. 13.035.154 □ 14
Art. 13.035.155 □ 16



Liscio / *Smooth*
H.200 mm
Art. 13.035.300
≠ 25 x 8 mm
Art. 13.035.301
≠ 30 x 8 mm



H.150 X L.40 mm.
Art. 13.036 □ 12



H.180 X L.45 mm.
Art. 13.037 □ 14



H.190 X L.50 mm.
Art. 13.038 □ 16



H.200 X L.55 mm.
Art. 13.039 □ 18



H.210 X L.62 mm.
Art. 13.040 □ 20



H.125 X L.60 mm.
Art. 13.041 Ø 13



H.155 X L.70 mm.
Art. 13.042 Ø 16



H.190 X L.90 mm.
Art. 13.043 Ø 16



H.130 X L.50 mm.
Art. 13.044 Ø 15



H.130 X L.53 mm.
Art. 13.045 Ø 13



H.160 X L.65 mm.
Art. 13.046 Ø 17



H.195 X L.75 mm.
Art. 13.047 Ø 17



H.110 X L.60 mm.
Art. 13.048 Ø 20

Fornite con inserto di plastica separato / *Provided with separate plastic thread*

Esempio di utilizzo
Example of use

H.125 X L.58 mm.
Art. 13.051.01
Fuori Produzione
Out of Production

H.155 X L.70 mm.
Art. 13.051.03
Fuori Produzione
Out of Production

H.125 X L.60 mm.
Art. 13.051.05
Fuori Produzione
Out of Production

H.155 X L.70 mm.
Art. 13.051.07
base Ø 30 mm.
foro Ø 16,5 mm.

Art. 13.051.02
Fuori Produzione
Out of Production

Art. 13.051.04
Fuori Produzione
Out of Production

Art. 13.051.06
base Ø 26 mm.
foro □ 12,5 mm.

Art. 13.051.08
base Ø 30 mm.
foro □ 14,5 mm.

Tutte le parti di questo catalogo - foto comprese - sono di proprietà Euro-Fer. La riproduzione, anche parziale, è vietata in ogni forma e con ogni mezzo. / Every part of this catalogue - photos included - is Euro-Fer's property. All forms of copying are strictly prohibited.

from art. 13.035.80 to art. 13.051.08

EUROFER

205



H.130 X L.60 mm.
Art. 13.052 Ø12



H.130 X L.60 mm.
Art. 13.052.01 Ø12



H.130 X L.60 mm.
Art. 13.052.02
base Ø 12 mm.



H.155 X L.70 mm.
Art. 13.053 Ø 17



H.190 X L.95 mm.
Art. 13.054 Ø 20



H.80 X L.45 mm.
Art. 13.055 Ø 20



H.78 X L.45 mm.
Art. 13.055.F12 Ø 12



H.125 X L.65 mm.
Art. 13.056 Ø 25



H.140 X L.80 mm.
Art. 13.057 Ø 38



H.120 X L.55 mm.
Art. 13.058 Ø 20



H.135 X L.65 mm.
Art. 13.059 Ø 25



H.125 X L.63 mm.
Art. 13.059.01 Ø 24

H.138 X L.67 mm.
Art. 13.059.02 Ø 25
H.163 X L.83 mm.
Art. 13.059.03 Ø 30



H.115 X L.58 mm.
Art. 13.060 Ø 20



H.115 X L.58 mm.
Art. 13.060.02
base Ø 21,5 mm.

H.140 X L.70 mm.
Art. 13.061.02
base Ø 26 mm.



H.113 X L.57 mm.
Art. 13.060.F12 Ø 12



H.140 X L.70 mm.
Art. 13.061 Ø 26



H.70 X L.60 mm.
Art. 13.062 □ 12



H.130 X L.60 mm.
Art. 13.063.01 □ 14

Decorazioni con vetro colorato / Coloured glass decorations



H.140 X L.60 mm.
Art. 13.064 ≙ 14X 8



H.125 mm.
Art. 13.064.01
base Ø 15 mm.
H.100 mm.
Art. 13.064.02
base Ø 12 mm.



H.125 mm.
Art. 13.064.03
base Ø 15 mm.
H.100 mm.
Art. 13.064.04
base Ø 12 mm.



H.120 X L.42 mm.
Art. 13.065 □12
H.140 X L.46 mm.
Art. 13.066 □14



H.150 mm.
Art. 13.067 □ 14



H.125 mm. - base Ø 15 mm.
Art. 13.067.01 Rosso / Red
Art. 13.067.02 Azzurro Int. / Intense Azure
Art. 13.067.03 Verde Smeraldo / Green
Art. 13.067.04 Giallo Vivace / Vivid Yellow
Art. 13.067.06 Blu Oltremare / Dark Blue



H.100 mm. - base Ø 12 mm.
Art. 13.067.07 Rosso / Red
Art. 13.067.09 Verde Smeraldo / Green



H.170 X L.52 mm.
Art. 13.068 □ 14



H.150 X L.45 mm.
Art. 13.070 □ 14
base Ø28



H.150 X L.40 mm.
Art. 13.070.01
base □ 16



H.125 X L.40 mm.
Art. 13.071 Ø 25



H.135 X L.40 mm.
Art. 13.072 Ø 25



H.160 X L.50 mm.
Art. 13.073 Ø 30



H.190 X L.55 mm.
Art. 13.074 Ø 32



H.175 X L.60 mm.
Art. 13.075 Ø 35



H.195 X L.55 mm.
Art. 13.076 Ø 38

Tutte le parti di questo catalogo - foto comprese - sono di proprietà Euro-Fer. La riproduzione, anche parziale, è vietata in ogni forma e con ogni mezzo. / Every part of this catalogue - photos included - is Euro-Fer's property. All forms of copying are strictly prohibited.



H.125 X L.60 mm.
Art. 13.077 Ø 32



H.110 mm.
Art. 13.077.01
base Ø 25 mm.



H.110 mm.
Art. 13.077.02
base Ø 25 mm.



H.110 X L.60 mm.
Art. 13.077.04



H.125 X L.65 mm.
Art. 13.077.05



H.140 X L.70 mm.
Art. 13.077.06



H.140 X L.60 mm.
Art. 13.078 □ 15



H.130 X L.70 mm.
Art. 13.079 □ 20

H.125 mm.
Art. 13.077.03
base Ø 32 mm.



H.155 X L.65 mm.
Art. 13.080 Ø 16



H.190 mm.
Art. 13.080.01
base Ø 35 mm.



H.200 mm.
Art. 13.080.03
base Ø 32 mm.



H.150 mm.
Art. 13.080.07
base Ø 16 mm.



H.125 X L.45 mm.
Art. 13.083 Ø 25



H.140 X L.57 mm.
Art. 13.084 Ø 33



H.190 X L.68 mm.
Art. 13.085 Ø 40

H.142 mm.
Art. 13.080.02
base Ø 28 mm.

H.125 x L.50 mm
Art. 13.080.08 Ø 25 mm

H.160 mm.
Art. 13.080.04
base Ø 26 mm.

H.110 mm.
Art. 13.080.06
base Ø 18 mm.



H.133 mm.
Art. 13.085.01
base □ 20



H.260 X L.24 mm.
Art. 13.086 Ø 17



H.260 mm.
Art. 13.086.01
base Ø 50 mm.



H.150 mm.
Art. 13.086.03
base Ø 30 mm.



H.110 X L.36 mm.
Art. 13.086.04
base Ø 25 mm.



H.200 mm.
Art. 13.086.05 Ø 12
Art. 13.086.06 Ø 14
Art. 13.086.09 Ø 25



H.110 X L.27 mm.
Art. 13.087 Ø 27



H.130 x L.32 mm
Art. 13.087.01 □ 30

H.180 mm.
Art. 13.086.02
base Ø 35 mm.



H.150 mm.
Art. 13.090.01
base □ 40 mm.

H.125 mm.
Art. 13.090.03
base □ 25 mm.



H.125 X L.32 mm.
Art. 13.088 Ø 32



H.160 X L.25 mm.
Art. 13.089 □ 25



H.120 mm.
Art. 13.089.01
base □ 18



H.150 X L.40 mm.
Art. 13.090 □ 40

H.135 mm.
Art. 13.090.02
base □ 32 mm.

H.100 mm.
Art. 13.090.04
base □ 20 mm.



H.125 X L.30 mm.
Art. 13.091
base □ 20 mm.
quadrello □ 10 mm.



H.125 X L.30 mm.
Art. 13.092 □ 20

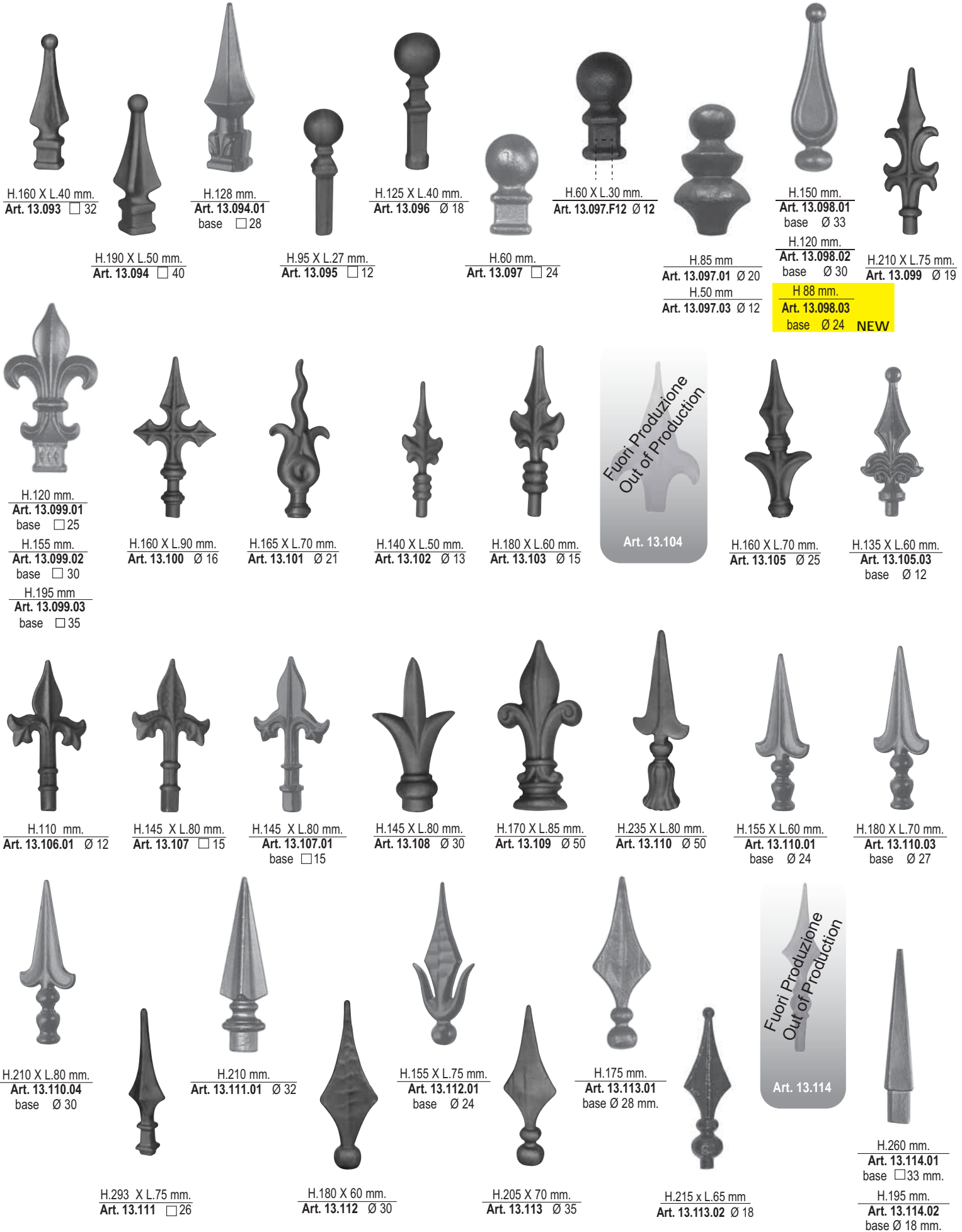

H.160 X L.40 mm.
Art. 13.093 □ 32

H.128 mm.
Art. 13.094.01
base □ 28

H.125 X L.40 mm.
Art. 13.096 Ø 18

H.60 X L.30 mm.
Art. 13.097.F12 Ø 12

H.150 mm.
Art. 13.098.01
base Ø 33

H.210 X L.75 mm.
Art. 13.099 Ø 19

H.190 X L.50 mm.
Art. 13.094 □ 40

H.95 X L.27 mm.
Art. 13.095 □ 12

H.60 mm.
Art. 13.097 □ 24

H.85 mm
Art. 13.097.01 Ø 20

H.50 mm
Art. 13.097.03 Ø 12

H.120 mm.
Art. 13.098.02
base Ø 30

H 88 mm.
Art. 13.098.03
base Ø 24 **NEW**

H.120 mm.
Art. 13.099.01
base □ 25

H.155 mm.
Art. 13.099.02
base □ 30

H.195 mm
Art. 13.099.03
base □ 35

H.160 X L.90 mm.
Art. 13.100 Ø 16

H.165 X L.70 mm.
Art. 13.101 Ø 21

H.140 X L.50 mm.
Art. 13.102 Ø 13

H.180 X L.60 mm.
Art. 13.103 Ø 15

Fuori Produzione
Out of Production
Art. 13.104

H.160 X L.70 mm.
Art. 13.105 Ø 25

H.135 X L.60 mm.
Art. 13.105.03
base Ø 12

H.110 mm.
Art. 13.106.01 Ø 12

H.145 X L.80 mm.
Art. 13.107 □ 15

H.145 X L.80 mm.
Art. 13.107.01
base □ 15

H.145 X L.80 mm.
Art. 13.108 Ø 30

H.170 X L.85 mm.
Art. 13.109 Ø 50

H.235 X L.80 mm.
Art. 13.110 Ø 50

H.155 X L.60 mm.
Art. 13.110.01
base Ø 24

H.180 X L.70 mm.
Art. 13.110.03
base Ø 27

H.210 X L.80 mm.
Art. 13.110.04
base Ø 30

H.210 mm.
Art. 13.111.01 Ø 32

H.155 X L.75 mm.
Art. 13.112.01
base Ø 24

H.175 mm.
Art. 13.113.01
base Ø 28 mm.

Fuori Produzione
Out of Production
Art. 13.114

H.293 X L.75 mm.
Art. 13.111 □ 26

H.180 X 60 mm.
Art. 13.112 Ø 30

H.205 X 70 mm.
Art. 13.113 Ø 35

H.215 x L.65 mm
Art. 13.113.02 Ø 18

H.260 mm.
Art. 13.114.01
base □ 33 mm.

H.195 mm.
Art. 13.114.02
base Ø 18 mm.

Tutte le parti di questo catalogo - foto comprese - sono di proprietà Euro-Fer. La riproduzione, anche parziale, è vietata in ogni forma e con ogni mezzo. / Every part of this catalogue - photos included - is Euro-Fer's property . All forms of copying are strictly prohibited.



H.135 X L.48 mm.
Art. 13.115 Ø 29



H.165 X L.53 mm.
Art. 13.116 Ø 29



H.180 X L.55 mm.
Art. 13.117 Ø 29



H.170 X L.58 mm.
Art. 13.117.01 Ø 30

H.138 X L.53 mm.
Art. 13.115.01 Ø 28

H.160 X L.56 mm.
Art. 13.116.01 Ø 28



H.205 X L.62 mm.
Art. 13.118 Ø 35



H.243 X L.72 mm.
Art. 13.119 Ø 40



H.95 X L.40 mm.
Art. 13.120
base ≙ 12 X 4



H.140 X L.55 mm.
Art. 13.121
base ≙ 15 X 4



H.170 X L.60 mm.
Art. 13.122
base ≙ 20 X 8



H.180 X L.55 mm.
Art. 13.123 Ø 37



H.200 X L.55 mm.
Art. 13.124 Ø 35



H.190 X L.55 mm.
Art. 13.125 Ø 30



H.130 X L.47 mm.
Art. 13.126 Ø 33



H.130 X L.33 mm.
Art. 13.127 Ø 30



H.135 X L.30 mm.
Art. 13.128 □ 30



H.145 mm.
Art. 13.129 □ 25
Art. 13.130 □ 30



H.155 mm.
Liscio / Smooth
Art. 13.131 □ 35
Art. 13.132 □ 40



H.155 mm.
Liscio / Smooth
Art. 13.131.01 □ 50

NEW



H.66 mm.
Liscio / Smooth
Art. 13.131.02 □ 29



H.115 X L.30 mm.
Art. 13.132.01 □ 8



H.220 X L.30 mm.
Art. 13.132.02 □ 12



H.39 X L.40 mm.
Art. 13.133



H.67 X L.40 mm.
Art. 13.134



H.39 X L.40 mm.
Art. 13.135 Ø 12,5
Art. 13.136 Ø 14,5
Art. 13.137 Ø 16,5

H.36 x L.37 mm
Art. 13.135.E Ø 12,5
Art. 13.136.E Ø 14,5
Art. 13.137.E Ø 16,5

Rullate / Rolled
H.39 x L.40 mm
Art. 13.135.R Ø 12,5
Art. 13.136.R Ø 14,5
Art. 13.137.R Ø 16,5



Borchie Svasate /
Countersunk Ironstud
H.39 x L.40 mm
Art. 13.135.B Ø 12,5
Art. 13.136.B Ø 14,5
Art. 13.137.B Ø 16,5



H.67 X L.40 mm.
Art. 13.138 Ø 12,5
Art. 13.139 Ø 14,5
Art. 13.140 Ø 16,5

H.63 x L.37 mm
Art. 13.138.E Ø 12,5
Art. 13.139.E Ø 14,5
Art. 13.140.E Ø 16,5

Rullate / Rolled
H.67 x L.40 mm
Art. 13.138.R Ø 12,5
Art. 13.139.R Ø 14,5
Art. 13.140.R Ø 16,5

H.63 x L.38 mm
Art. 13.140.RE Ø 16,5

NUOVE BORCHIE IN TUBO / NEW STUDS IN TUBE



H.39 x L. 40 mm
Art. TB.13.135 Ø 12,5
Art. TB.13.136 Ø 14,5
Art. TB.13.137 Ø 16,5



H.67 x L. 40 mm
Art. TB.13.138 Ø 12,5
Art. TB.13.139 Ø 14,5
Art. TB.13.140 Ø 16,5



H.39 x L. 40 mm
Art. TB.13.141 □ 12,5



H.67 x L. 40 mm
Art. TB.13.142 □ 12,5

H.44 x L. 45 mm
Art. TB.13.150 □ 14,5
Art. TB.13.150.01 □ 16,5

H.67 x L. 45 mm
Art. TB.13.152 □ 14,5
Art. TB.13.153 □ 16,5

**Attenzione: Sezione Cava! Eventualmente, avvisare lo zincatore.
Be Careful: Hole Section! Eventually, inform the galvanizer.**

Tutte le parti di questo catalogo - foto comprese - sono di proprietà Euro-Fer. La riproduzione, anche parziale, è vietata in ogni forma e con ogni mezzo. / Every part of this catalogue - photos included - is Euro-Fer's property. All forms of copying are strictly prohibited.

Articoli in ferro fuso / Cast steel items
Senza inserto / Without insert



H.65 x L.40 mm
Art. CS.13.142 □ 12,5



H.67 x L.45 mm
Art. CS.13.151 □ 12,5
Art. CS.13.152 □ 14,5
Art. CS.13.153 □ 16,5



H.39 x L.40 mm
Art. 13.141 □ 12,5

Rullate / Rolled
H.39 x L.40 mm
Art. 13.141.R □ 12,5



H.67 X L.40 mm.
Art. 13.142 □ 12,5

Rullate / Rolled
H.67 X L.40 mm.
Art. 13.142.R □ 12,5

H.63 x L.38 mm
Art. 13.142.RE □ 12,5



H.44 X L.45 mm.
Art. 13.143

Rullate / Rolled
H.44 X L.45 mm.
Art. 13.143.R



H.67 X L.45 mm.
Art. 13.144

Rullate / Rolled
H.67 X L.45 mm.
Art. 13.144.R



H.44 X L. 45 mm.
Art. 13.145 Ø 14,5
Art. 13.146 Ø 16,5
Art. 13.146.01 Ø 18,5
Art. 13.146.02 Ø 20,5

Rullate / Rolled
H.44 X L. 45 mm.
Art. 13.145.R Ø 14,5
Art. 13.146.R Ø 16,5
Art. 13.146.01.R Ø 18,5



H.67 X L. 45 mm.
Art. 13.147 Ø 14,5
Art. 13.148 Ø 16,5
Art. 13.148.01 Ø 18,5
Art. 13.148.02 Ø 20,5



H.44 X L.45 mm.
Art. 13.149 □ 12,5
Art. 13.150 □ 14,5
Art. 13.150.01 □ 16,5

Rullate / Rolled
H.67 X L. 45 mm.
Art. 13.147.R Ø 14,5
Art. 13.148.R Ø 16,5
Art. 13.148.01.R Ø 18,5



H.67 X L.45 mm.
Art. 13.151 □ 12,5
Art. 13.152 □ 14,5
Art. 13.153 □ 16,5

Rullate / Rolled
H.67 X L.45 mm.
Art. 13.151.R □ 12,5
Art. 13.152.R □ 14,5
Art. 13.153.R □ 16,5



H.47 X L.50 mm.
Art. 13.154



Art. 13.155



H.47 X L.50 mm.
Art. 13.156 Ø 16,5
Art. 13.157 Ø 18,5
Art. 13.158 Ø 20,5
Art. 13.158.01 Ø 22,5



H.80 X L.50 mm.
Art. 13.159 Ø 16,5
Art. 13.160 Ø 18,5
Art. 13.161 Ø 20,5
Art. 13.161.01 Ø 22,5



H.47 X L.50 mm.
Art. 13.162 □ 14,5
Art. 13.163 □ 16,5



H.80 X L.50 mm.
Art. 13.164 □ 14,5
Art. 13.165 □ 16,5

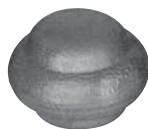

H.25 X L.35 mm.
Art. 13.166

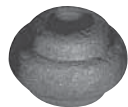

H.25 X L.35 mm.
Art. 13.167 Ø 12,5
Art. 13.167.01 Ø 14,5
Art. 13.167.02 Ø 16,5

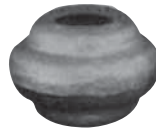

H.25 X L.35 mm.
Art. 13.167.03 □ 12,5
Art. 13.167.04 □ 14,5

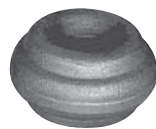

H.22 X L.40 mm.
Art. 13.168 Ø 14,5
Art. 13.168.01 Ø 16,5
Art. 13.168.02 Ø 12,5



H.35 X L.55 mm.
Art. 13.168.03 Ø 18,5
Art. 13.168.04 Ø 20,5
Art. 13.168.05 Ø 25,5
Art. 13.168.06 Ø 30,5



H.35 X L.55 mm.
Art. 13.168.07 □ 20,5
Art. 13.168.08 □ 25,5
non in produzione
not in production

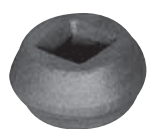

H.22 X L.40 mm.
Art. 13.169 □ 14,5
Art. 13.169.01 □ 16,5
Art. 13.169.02 □ 12,5



H.22 X L.33 mm.
Art. 13.169.03 □ 12,5
H.22 X L.38 mm.
Art. 13.169.05 □ 14,5
Art. 13.169.06 □ 16,5



H.35 X L.55 mm.
Art. 13.169.07 □ 20,5
Art. 13.169.08 □ 22,5
Art. 13.169.09 □ 25,5



H.32 X L.47 mm.
Art. 13.169.10 □ 12,5
Art. 13.169.11 □ 14,5
Art. 13.169.12 □ 16,5
Art. 13.169.13 □ 18,5



H.60 X L.35 mm.
Art. 13.170.R



H.30 X L.35 mm.
Art. 13.170.01.R



H.60 X L.35 mm.
Art. 13.171.R Ø 14,5
Art. 13.172.R Ø 16,5
Art. 13.173.R Ø 18,5
Art. 13.173.01.R Ø 12,5
Art. 13.173.02.R □ 12



H.30 X L.35 mm.
Art. 13.173.03.R Ø 12,5
Art. 13.173.04.R Ø 14,5
Art. 13.173.05.R Ø 16,5
Art. 13.173.06.R Ø 18,5
Art. 13.173.07.R □ 12

BORCHIE TORNITE / TURNED BUSHES



H.24 X L.35 mm.
Art. 13.173.08 Ø 12,5
Art. 13.173.09 Ø 14,5
Art. 13.173.10 Ø 16,5



H.20 X L.40 mm.
Art. 13.173.11 Ø 12,5
Art. 13.173.12 Ø 14,5
Art. 13.173.13 Ø 16,5



H.25 X L.40 mm.
Art. 13.173.14 Ø 25,5



H.26 X L.35 mm.
Art. 13.173.15 Ø 12,5
Art. 13.173.16 Ø 14,5
Art. 13.173.17 Ø 16,5
Art. 13.173.18 Ø 18,5



H.60 X L.35 mm.
Art. 13.173.19 Ø 12,5
Art. 13.173.20 Ø 14,5
Art. 13.173.21 Ø 16,5
Art. 13.173.22 Ø 18,5



H.60 X L.35 mm.
Art. 13.173.23 Ø 14,5



H.25 X L.35 mm.
Art. 13.173.24 Ø 14,5



H.25 X L.35 mm.
Art. 13.173.25 Ø 14,5



H.24 X L.35 mm.
Art. 13.173.26 Ø 14,5



H.23 X L.35 mm.
Art. 13.173.27 Ø 14,5



H.7 X L.15 mm.
Art. 13.173.28
foro Ø 8



H.55 X L.40 mm.
Art. 13.175 Ø 14,5
Art. 13.175.01 Ø 16,5
Art. 13.175.02 Ø 12,5
Art. 13.175.03 □ 12



H.52 X L.69 mm.
Art. 13.176



H.80 X L.69 mm.
Art. 13.177



H.52 X L.69 mm.
Art. 13.178 Ø 27,5
Art. 13.179 Ø 30,5
Art. 13.180 Ø 35,5
Art. 13.181 Ø 40,5
Art. 13.181.01 □ 25,5
Art. 13.181.02 □ 30,5



H.80 X L.69 mm.
Art. 13.182 Ø 27,5
Art. 13.183 Ø 30,5
Art. 13.184 Ø 35,5
Art. 13.185 Ø 40,5
Art. 13.185.01 □ 25,5
Art. 13.185.02 □ 30,5



H.55 X L.35 mm.
Art. 13.185.03



H.55 X L.35 mm.
Art. 13.185.04 Ø 12,5
Art. 13.185.05 Ø 14,5
Art. 13.185.06 Ø 16,5
Art. 13.185.07 Ø 18,5



H.55 X L.35 mm.
Art. 13.185.08 □ 12,5
Art. 13.185.09 □ 14,5
non in produzione
not in production



H.75 X L.49 mm.
Art. 13.185.10



H.75 X L.49 mm.
Art. 13.185.11 Ø 16,5
Art. 13.185.12 Ø 18,5
Art. 13.185.13 Ø 20,5
Art. 13.185.14 Ø 22,5



H.75 X L.49 mm.
Art. 13.185.15 □ 14,5
Art. 13.185.16 □ 16,5



H.70 X L.64 mm.
Art. 13.185.17 □ 16,5
Art. 13.185.17.01 □ 14,5
NEW



H.55 x L.60 mm
Art. 13.185.18 base 37 Senza foro / Without hole
Art. 13.185.19 Ø 20,5 Art. 13.185.22 Ø 27,5
Art. 13.185.20 Ø 22,5 Art. 13.185.23 □ 14,5
Art. 13.185.21 Ø 25,5 Art. 13.185.24 □ 16,5



H.110 x L.40 mm
Art. 13.185.25 Ø 16,5



H.70 x L.45 mm
Art. 13.185.26 Ø 20



H.135 mm
Art. 13.185.27 Ø 14,5
H.150 mm
Art. 13.185.28 Ø 16,5



H.70 mm
Art. 13.185.30 Ø 14,5
H.80 mm
Art. 13.185.31 Ø 16,5



H.55 X L.47 mm.
Art. 13.186



H.55 X L.47 mm.
Art. 13.187 Ø 14,5
Art. 13.188 Ø 16,5
Art. 13.188.01 Ø 18,5
Art. 13.188.02 Ø 12,5
Art. 13.189 □ 14,5
Art. 13.190 □ 16,5
Art. 13.190.01 □ 12,5



H.125 X L.35 mm.
Art. 13.190.02 S.F.
Art. 13.190.03 Ø 12,5
Art. 13.190.04 Ø 14,5
Art. 13.190.05 Ø 16,5
Art. 13.190.06 Ø 18,5
Art. 13.190.07 □ 14,5
Art. 13.190.08 □ 16,5



H.120 X L.28 mm.
Art. 13.191 S.F.
Art. 13.192 Ø 14,5
Art. 13.193 Ø 16,5
Art. 13.193.01 Ø 12,5
Art. 13.193.02 □ 12,5

Tutte le parti di questo catalogo - foto comprese - sono di proprietà Euro-Fer. La riproduzione, anche parziale, è vietata in ogni forma e con ogni mezzo. / Every part of this catalogue - photos included - is Euro-Fer's property. All forms of copying are strictly prohibited.



H.70 X L.35 mm.

Art. 13.194 S.F.
Art. 13.195 Ø 16,5
Art. 13.195.01 Ø 18,5
Art. 13.195.02 Ø 14,5
Art. 13.195.03 Ø 12,5
Art. 13.195.04 □ 14,5
Art. 13.195.05 □ 16,5



H.64 X L.33 mm.

Art. 13.196 S.F.
Art. 13.197 Ø 14,5
Art. 13.198 Ø 16,5
Art. 13.198.01 Ø 12,5
Art. 13.198.02 □ 12,5



H.50 X L.45 mm.

Art. 13.199



H.90 X L.45 mm.

Art. 13.200

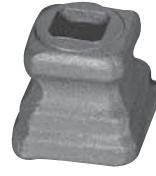

H.50 X L.45 mm.

Art. 13.201 □ 14,5
Art. 13.202 □ 16,5
Art. 13.202.01 □ 18,5
Art. 13.202.02 Ø 18,5
Art. 13.202.03 Ø 20,5
Art. 13.202.04 Ø 22,5
Art. 13.202.05 Ø 25,5



H.90 X L.45 mm.

Art. 13.203 Ø 14
Art. 13.204 Ø 18,5
Art. 13.204.01 Ø 20,5
Art. 13.204.02 Ø 22,5
Art. 13.204.03 Ø 25,5
Art. 13.205 □ 14,5
Art. 13.206 □ 16,5
Art. 13.206.01 □ 18,5



H.40 X L.40 mm.

Art. 13.207



H.68 X L.40 mm.

Art. 13.208

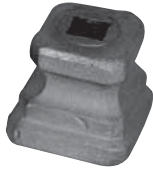

H.40 X L.40 mm.

Art. 13.209 □ 12,5
Art. 13.210 □ 14,5
Art. 13.210.01 □ 16,5
Art. 13.210.02 Ø 16,5
Art. 13.210.03 Ø 18,5
Art. 13.210.04 Ø 20,5
Art. 13.210.05 Ø 22,5



H.68 X L.40 mm.

Art. 13.211 □ 12,5
Art. 13.212 □ 14,5
Art. 13.213 □ 16,5
Art. 13.213.01 Ø 16,5
Art. 13.213.02 Ø 18,5
Art. 13.213.03 Ø 20,5
Art. 13.213.04 Ø 22,5



H.45 X L.40 mm.

Art. 13.213.05 □ 12,5
Art. 13.213.06 □ 14,5



H.25 X L.40 mm.

Art. 13.213.07 □ 12,5
Art. 13.213.08 □ 14,5



H.45 X L.40 mm.

Art. 13.213.10 Ø 14,5
Art. 13.213.11 Ø 16,5



H.25 X L.40 mm.

Art. 13.213.12 Ø 12,5
Art. 13.213.13 Ø 14,5
Art. 13.213.14 Ø 16,5

BORCHIE IN TUBO DI FERRO / TUBULAR IRON BUSHES



H.90 X L.40 mm

Art. TB.13.213.16 Ø 14,5



H.45 X L.30 mm

Art. TB.13.213.19 Ø 12,5
Art. TB.13.213.20 Ø 14,5



H.15 X L.30 mm

Art. TB.13.213.22 Ø 14,5



H.68 X L. 30 mm

Art. TB.13.213.17 Ø 12,5
Art. TB.13.213.18 Ø 14,5



H.20 x L. 30 mm

Art. TB.13.213.23 Ø 12,5



H.118 x L. 40 mm

Art. TB.13.213.25 Ø 14,5
Art. TB.13.213.26 Ø 16,5



H.140 x L. 30 mm

Art. TB.13.213.30 Ø 12,5
Art. TB.13.213.31 Ø 14,5



H.118 x L. 30 mm

Art. TB.13.213.34 Ø 12,5
Art. TB.13.213.35 Ø 14,5



H.83 x L. 30 mm

Art. TB.13.213.38 Ø 12,5
Art. TB.13.213.39 Ø 14,5



H.65 x L. 30 mm

Art. TB.13.213.44 Ø 12,5
Art. TB.13.213.45 Ø 14,5



H.90 X L. base 40 mm.
Art. 13.214



H.90 X L. base 40 mm.
Art. 13.214.01



H.120 X L. base 55 mm.
Art. 13.216

H.190 X L. base 90 mm.
Art. 13.216.01

H.150 X L. base 70 mm.
Art. 13.216.02

H.85 X L. base 43 mm.
Art. 13.216.03

H.55 X L. base 28 mm.
Art. 13.216.04



H.90 mm.
Art. 13.217
base Ø 50 mm.



H.180 mm.
Art. 13.218
base Ø 100 mm.



H. 57 X L. base 36 mm.
Art. 13.218.01
base □ 16 mm.



H.80 mm.
Art. 13.219
base 28 mm.



H.100 mm.
Art. 13.220
base 50 mm.



H.180 mm.
Art. 13.221
base 100 mm.



H.140 mm. - sfera Ø 110
Art. 13.221.01
base Ø 90 mm.

H.125 mm. - sfera Ø 90
Art. 13.221.02
base Ø 70 mm.



H.100 mm. - sfera Ø 70
Art. 13.221.03
base Ø 55 mm.

H.85 mm. - sfera Ø 55
Art. 13.221.04
base Ø 45 mm.



H.200 mm.
Art. 13.221.05
base Ø 50 mm.



H.100 mm.
Art. 13.222
base Ø 50 mm.

H.180 mm.
Art. 13.222.01
base Ø 100 mm.



Art. 13.223



H.90 X L.35 mm.
Art. 13.223.01 Ø 16,5
Art. 13.223.02 Ø 18,5
Art. 13.223.03 Ø 22,5



H.90 X L.35 mm.
Art. 13.223.04 □ 14,5
Art. 13.223.05 □ 16,5



H.135 X L.36 mm.
Art. 13.223.06 Senza foro/Without hole
Art. 13.223.07 Con foro/With hole Ø 12,5
Art. 13.223.08 Con foro/With hole Ø 14,5
Art. 13.223.09 Con foro/With hole Ø 16,5
Art. 13.223.10 Con foro/With hole □ 12,5



H.75 X L.36 mm.
Art. 13.223.11 Senza foro/Without hole
Art. 13.223.12 Con foro/With hole Ø 12,5
Art. 13.223.13 Con foro/With hole Ø 14,5
Art. 13.223.14 Con foro/With hole Ø 16,5
Art. 13.223.15 Con foro/With hole □ 12,5



H.48 X L.38 mm.
Art. 13.223.16 Senza foro/Without hole
Art. 13.223.17 Con foro/With hole Ø 12,5
Art. 13.223.18 Con foro/With hole Ø 14,5
Art. 13.223.19 Con foro/With hole Ø 16,5
Art. 13.223.20 Con foro/With hole □ 12,5



H.96 X L.38 mm.
Art. 13.223.21 Senza foro/Without hole
Art. 13.223.22 Con foro/With hole Ø 12,5
Art. 13.223.23 Con foro/With hole Ø 14,5
Art. 13.223.24 Con foro/With hole Ø 16,5
Art. 13.223.25 Con foro/With hole □ 12,5



H.40 X L.30 mm.
Art. 13.223.26 Ø 12,5
Art. 13.223.27 Ø 14,5
Art. 13.223.28 □ 12,5



H.90 mm.
Art. 13.224.01
base Ø 40 mm.
H.65 mm.
Art. 13.224.02
base Ø 27 mm.



H.70 X L.30 mm.
Art. 13.224.03
base □ 23 mm.



H.60 X L.43 mm.
Art. 13.225



H.50 X L.35 mm.
Art. 13.226



H.130 mm.
Art. 13.227
Ø 75 mm.



H.120 mm.
Art. 13.228
Ø 75 mm.



H.155 X L.60 mm.
Art. 13.228.01
base Ø 35 mm.



H.120 mm.
Art. 13.229
Ø 75 mm.



H.90 X L.50 mm.
Art. 13.229.01
base Ø 33 mm.



H.100 mm.
Art. 13.230
Ø 55 mm.



H.155 X L.50 mm.
Art. 13.230.01
base Ø 22 mm.



H.130 mm.
Art. 13.231
Ø 60 mm.



H.90 mm.
Art. 13.232
Ø 50 mm.



H.100 mm.
Art. 13.233
Ø 55 mm.



H.75 X L.30 mm.
Art. 13.233.01



H.50 X L.30 mm.
Art. 13.234



H.65 X L.35 mm.
Art. 13.235



H.60 mm.
Art. 13.235.01
base □ 25 mm.
H.85 mm.
Art. 13.235.02
base □ 40 mm.
H.125 mm.
Art. 13.235.03
base □ 60 mm.



H.150 mm.
Art. 13.235.04
base □ 80 mm.
H.60 mm.
Art. 13.235.06
base Ø 27 mm.
H.85 mm.
Art. 13.235.07
base Ø 42 mm.
H.125 mm.
Art. 13.235.08
base Ø 48 mm.
H.150 mm.
Art. 13.235.09
base Ø 60 mm.
H.200 mm.
Art. 13.235.10
base Ø 90 mm.



H.150 mm. / Ø 100 mm.
Art. 13.235.11
base □ 100 mm.
H.120 mm. / Ø 80 mm.
Art. 13.235.12
base □ 80 mm.
H.105 mm. / Ø 70 mm.
Art. 13.235.13
base □ 60 mm.
H.75 mm. / Ø 50 mm.
Art. 13.235.14
base □ 40 mm.
H.45 mm. / Ø 30 mm.
Art. 13.235.15
base □ 25 mm.



H.45 mm.
Art. 13.236
Ø 30 mm.
H.65 mm.
Art. 13.237
Ø 50 mm.
H.70 mm.
Art. 13.238
Ø 55 mm.
H.80 mm.
Art. 13.239
Ø 65 mm.



Sfere Lisce / Smooth Spheres

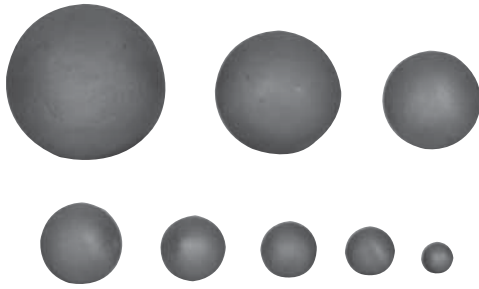

- Art. 13.240 Ø 15 mm.
- Art. 13.241 Ø 20 mm.
- Art. 13.242 Ø 25 mm.
- Art. 13.243 Ø 30 mm.
- Art. 13.244 Ø 35 mm.
- Art. 13.245 Ø 40 mm.
- Art. 13.246 Ø 50 mm.
- Art. 13.247 Ø 60 mm.
- Art. 13.248 Ø 70 mm.
- Art. 13.249 Ø 80 mm.
- Art. 13.250 Ø 90 mm.
- Art. 13.251 Ø 100 mm.
- Art. 13.251.01 Ø 120 mm.

Sfere Vuote in lamiera / Hollow Spheres in Iron Sheet

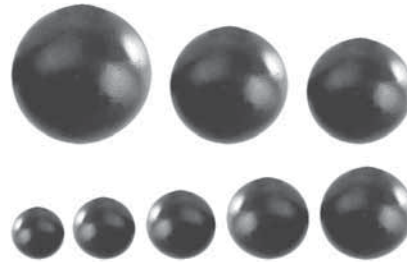

- Art. 13.251.30 Ø 30 mm.
- Art. 13.251.35 Ø 35 mm.
- Art. 13.251.40 Ø 40 mm.
- Art. 13.251.50 Ø 50 mm.
- Art. 13.251.60 Ø 60 mm.
- Art. 13.251.70 Ø 70 mm.
- Art. 13.251.80 Ø 80 mm.
- Art. 13.251.90 Ø 90 mm.
- Art. 13.251.100 Ø 100 mm.
- Art. 13.251.120 Ø 120 mm.
- Art. 13.251.150 Ø 150 mm.
- Art. 13.251.200 Ø 200 mm.

Si raccomanda di zincare a caldo le sfere vuote in lamiera solo dopo averle forate
It's recommended to perforate the Hollow Spheres before the hot galvanization

Sfere Schiacciate / Crushed Spheres

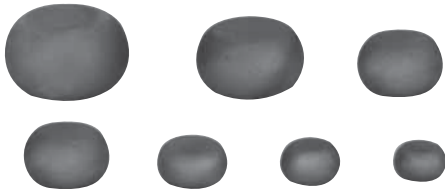

- H.50 X L.80 mm.
Art. 13.252
- H.40 X L.70 mm.
Art. 13.253
- H.35 X L.55 mm.
Art. 13.254
- H.28 X L.45 mm.
Art. 13.255
- H.26 X L.40 mm.
Art. 13.256
- H.22 X L.35 mm.
Art. 13.257

Sfere Forgiate Diamantate / Diamond Forged Spheres

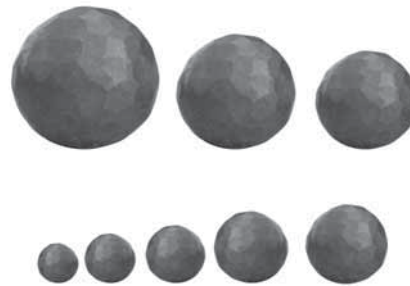

- Art. 13.252.20 Ø 20 mm.
- Art. 13.252.25 Ø 25 mm.
- Art. 13.252.30 Ø 30 mm.
- Art. 13.252.35 Ø 35 mm.
- Art. 13.252.40 Ø 40 mm.
- Art. 13.252.50 Ø 50 mm.
- Art. 13.252.60 Ø 60 mm.
- Art. 13.252.70 Ø 70 mm.
- Art. 13.252.80 Ø 80 mm.
- Art. 13.252.90 Ø 90 mm.
- Art. 13.252.100 Ø 100 mm.
- Art. 13.252.120 Ø 120 mm.
- Art. 13.252.150 Ø 150 mm.

Sfere Forgiate / Forged Spheres

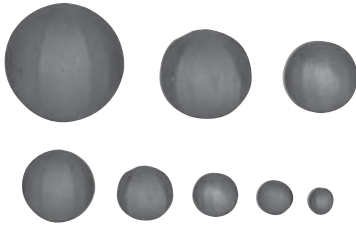

- Art. 13.258 Ø 20 mm.
- Art. 13.259 Ø 25 mm.
- Art. 13.260 Ø 30 mm.
- Art. 13.261 Ø 35 mm.
- Art. 13.262 Ø 40 mm.
- Art. 13.263 Ø 50 mm.
- Art. 13.264 Ø 60 mm.
- Art. 13.265 Ø 70 mm.
- Art. 13.266 Ø 80 mm.
- Art. 13.267 Ø 90 mm.
- Art. 13.268 Ø 100 mm.

Mezze sfere vuote in lamiera / Half hollow spheres in iron sheet

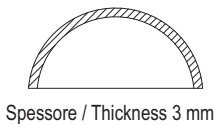

Spessore / Thickness 3 mm



- Art. 13.251.40H Ø 40 mm
- Art. 13.251.50H Ø 50 mm
- Art. 13.251.60H Ø 60 mm
- Art. 13.251.70H Ø 70 mm
- Art. 13.251.80H Ø 80 mm
- Art. 13.251.90H Ø 90 mm
- Art. 13.251.100H Ø 100 mm
- Art. 13.251.120H Ø 120 mm
- Art. 13.251.150H Ø 150 mm
- Art. 13.251.200H Ø 200 mm.

Sfere Piene Forate / Holed Solid Spheres

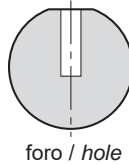

foro / hole

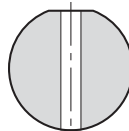

foro passante
passing hole

foro passante / passing hole



Ø 25 mm.

Art. 13.242.F12

foro / hole Ø 12,5 mm.

Art. 13.242.F12H

foro passante / passing hole Ø 12,5 mm.

Ø 30 mm.

Art. 13.243.F12

foro / hole Ø 12,5 mm.

Art. 13.243.F12H

foro passante / passing hole Ø 12,5 mm.



Ø 35 mm.

Art. 13.244.F12

foro / hole Ø 12,5 mm.

Art. 13.244.F12H

foro passante / passing hole Ø 12,5 mm.

Art. 13.244.F14

foro / hole Ø 14,5 mm.

Art. 13.244.F14H

foro passante / passing hole Ø 14,5 mm.

Art. 13.244.F16

foro / hole Ø 16,5 mm.

Art. 13.244.F16H

foro passante / passing hole Ø 16,5 mm.

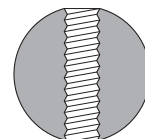
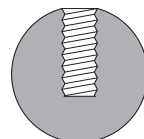

Sfere Piene Forate e Filettate / Solid Spheres with Threaded Hole

- Art. 13.268.50 Ø 12 mm. Filetto / Threaded M6 cieco
- Art. 13.268.51 Ø 12 mm. Filetto / Threaded M6 passante / passing
- Art. 13.268.60 Ø 16 mm. Filetto / Threaded M8 cieco
- Art. 13.268.61 Ø 16 mm. Filetto / Threaded M8 passante / passing
- Art. 13.268.65 Ø 20 mm. Filetto / Threaded M10 cieco
- Art. 13.268.66 Ø 20 mm. Filetto / Threaded M10 passante / passing

Pomoli in Ottone / *Brass Knobs*

H.55 X L.42 mm.
Art. 13.271
base 30 mm.
Filettato MA 10
Threaded MA 10



Art. 13.272



Art. 13.273

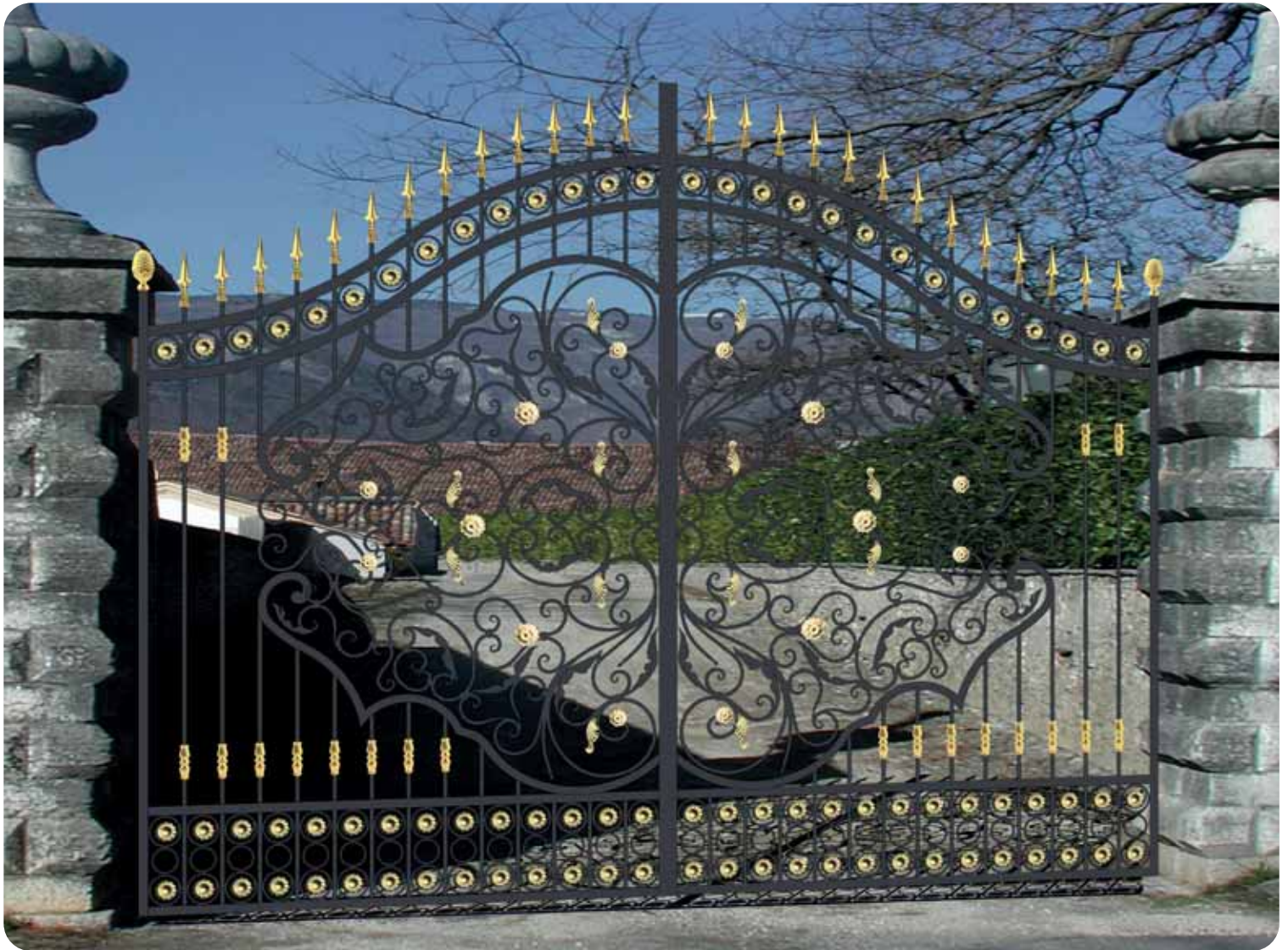

H.100 X L.60 mm
Art. 13.273.01
foro Ø 25,5 mm
base 30 mm
Filettato MA 10
Threaded MA 10

Pomoli in cristallo /
Crystal Knobs

Fissaggio con granello / Fastening with dowel



H.100 X L.65 mm.
Art. 13.273.05
Ø foro 35,5 mm.
base 50 mm.



H.40 X L.25 mm.
Art. 13.273.09
base 18 mm.

Filettato MA 4
With Threaded MA 4



H.60 mm.

Art. 13.274 Ø 12,5 mm. L.30
Art. 13.275 Ø 14,5 mm. L.32
Art. 13.276 Ø 16,5 mm. L.33
Art. 13.277 Ø 18,5 mm. L.35



H.60 mm.

Art. 13.278 Ø 12,5 mm. L.29
Art. 13.279 Ø 14,5 mm. L.31
Art. 13.280 Ø 16,5 mm. L.33
Art. 13.281 Ø 18,5 mm. L.36



H.40 X L.25 mm.

Art. 13.282 Ø 12,5 mm.
Art. 13.283 Ø 14,5 mm.
Art. 13.284 Ø 16,5 mm.
Art. 13.285 Ø 18,5 mm.



H.26 mm.

Art. 13.286 Ø 12,5 mm. L.30
Art. 13.287 Ø 14,5 mm. L.32



H.26 mm.

Art. 13.290 Ø 12,5 mm. L.29
Art. 13.291 Ø 14,5 mm. L.31

Fissaggio con granello / Fastening with dowel



H.26 X L.30 mm.

Art. 13.293.01
Ø foro 12,5 mm.

H.26 X L.32 mm.
Art. 13.293.02
Ø foro 14,5 mm.

H.26 X L.33 mm.
Art. 13.293.03
Ø foro 16,5 mm.

H.26 X L.35 mm.
Art. 13.293.04
Ø foro 18,5 mm.



H.60 X L.32 mm.

Art. 13.293.06
Ø foro 14,5 mm.

H.60 X L.33 mm.
Art. 13.293.07
Ø foro 16,5 mm.



H.26 X L.29 mm.

Art. 13.293.09
Ø foro 12,5 mm.

H.26 X L.33 mm.
Art. 13.293.10
Ø foro 14,5 mm.

H.26 X L.33 mm.
Art. 13.293.11
Ø foro 16,5 mm.

H.26 X L.36 mm.
Art. 13.293.12
Ø foro 18,5 mm.



H.60 X L.29 mm.

Art. 13.293.13
Ø foro 12,5 mm.

H.60 X L.33 mm.
Art. 13.293.15
Ø foro 16,5 mm.

H.60 X L.36 mm.
Art. 13.293.16
Ø foro 18,5 mm.



H.25 X L.35 mm.

Art. 13.294 Ø 14,5 mm.
Art. 13.295 Ø 12,5 mm.



H.83 X L.35 mm.

Art. 13.296
Ø foro 12,5 mm.

H.83 X L.35 mm.
Art. 13.296.01
Ø foro 14,5 mm.

Fissaggio con granello
Fastening with dowel



H.90 X L.20 mm.

Art. 13.297
Ø foro 12,5 mm.

Fissaggio con granello
Fastening with dowel

Fissaggio con granello / Fastening with dowel



H.42 X L.50 mm.

Art. 13.297.02
Ø foro 30,5 mm.

Fissaggio con granello
Fastening with dowel



H.55 X L.50 mm.

Art. 13.297.03
Ø foro 20,5 mm.

H.55 X L.50 mm.
Art. 13.297.04
Ø foro 25,5 mm.

Fissaggio con granello
Fastening with dowel



H.119 X L.48 mm.

Art. 13.297.05
Ø foro 30,5 mm.

Fissaggio con granello
Fastening with dowel



H.120 X L.65 mm.

Art. 13.297.06
Ø foro 25,5 mm.

H.120 X L.65 mm.
Art. 13.297.07
Ø foro 30,5 mm.

Fissaggio con granello
Fastening with dowel



H.260 X L.50 mm.

Art. 13.297.09
Ø foro 25,5 mm.

Fissaggio con granello
Fastening with dowel



H.55 X L.63 mm.

Art. 13.297.10
Ø foro 25,5 mm.

H.60 X L.73 mm.
Art. 13.297.11
Ø foro 30,5 mm.

H.60 X L.73 mm.
Art. 13.297.12
Ø foro 35,5 mm.

Fissaggio con granello / Fastening with dowel



H.20 X Base 80 X 80 mm.

Art. 13.297.15
□ foro 25,5 mm.



H.13 X Base 24 X 24 mm.

Art. 13.297.17
□ foro 14,5 mm.



H.15 X Base 30 X 30 mm.

Art. 13.297.18
□ foro 20,5 mm.

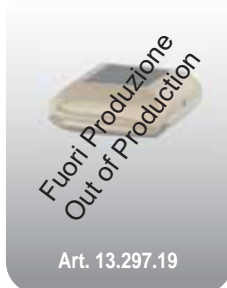

Art. 13.297.19



H.50 X L.33 mm.

Art. 13.298 Ø 22 mm

H.50 X L.37 mm.
Art. 13.299 Ø 30 mm

**BORCHIE, LANCE E PIASTRE
STUDS, SPEARS AND PLATES**

H.110 X L.110 mm. - sp.10 mm.
Art. 13.300 □ foro 26 mm.
Art. 13.301 □ foro 31 mm.

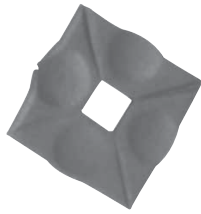

H.70 X L.70 mm. - sp.8 mm.
Art. 13.304 □ foro 16,5 mm.
Art. 13.305 □ foro 21 mm.

H.50 X L.50 mm. - sp. 6 mm.
Art. 13.306 □ foro 12,5 mm.
Art. 13.306.01 □ foro 14,5 mm.
Art. 13.307 □ foro 16,5 mm.

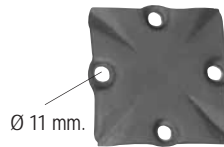

H.100 X L.100 mm.
Art. 13.308
 Spessore 10 mm.



H.100 X L.100 mm.
Art. 13.309
 Spessore 10 mm.

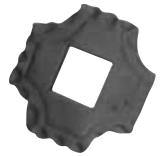

H.70 X L.70 mm. - sp.4 mm.
Art. 13.310 □ Foro 24 mm.

NEW



H.80 X L.80 mm.
Art. 13.310.10
 Spessore 8 mm.



H.100 X L.100 mm.
Art. 13.311
 Spessore 10 mm.



H.100 X L.100 mm. - sp.10 mm.
Art. 13.312 □ Foro 25 mm.
Art. 13.313 □ Foro 30 mm.



H.22 mm.
Art. 13.313.01
 Base 120 mm.



H.22 X Base 120 mm.
Art. 13.313.02 Ø Foro 50,5 mm.
Art. 13.313.03 Ø Foro 65,5 mm.
Art. 13.313.04 Ø Foro 80,5 mm.



H.20 mm.
Art. 13.314 Base 80 mm.
Art. 13.315 Base 60 mm.
Art. 13.316 Base 50 mm.
Art. 13.317 Base 40 mm.
Art. 13.318 B. 30 X 35 mm.

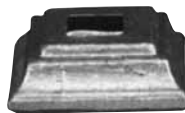

Base 80 X 80 H.20 mm.
Art. 13.319 □ Foro 30,5 mm.
Art. 13.320 □ Foro 35,5 mm.
Art. 13.321 □ Foro 40,5 mm.

Base 60 X 60 H.20 mm.
Art. 13.322 □ Foro 25,5 mm.
Art. 13.323 □ Foro 30,5 mm.

Base 50 X 50 H.20 mm.
Art. 13.324 □ Foro 16,5 mm.
Art. 13.325 □ Foro 18,5 mm.
Art. 13.326 □ Foro 20,5 mm.

Base 40 X 40 H.20 mm.
Art. 13.327 □ Foro 12,5 mm.
Art. 13.328 □ Foro 14,5 mm.
Art. 13.329 □ Foro 16,5 mm.

Base 36 X 30 H.20 mm.
Art. 13.330 □ Foro 12,5 mm.
Art. 13.331 □ Foro 14,5 mm.
Art. 13.332 □ Foro 12X15 mm.

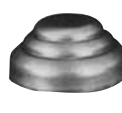

Art. 13.333
 Base Ø 80 mm.

Art. 13.334
 Base Ø 60 mm.

Art. 13.335
 Base Ø 50 mm.

Art. 13.336
 Base Ø 40 mm.

Art. 13.337
 Base Ø 30 mm.

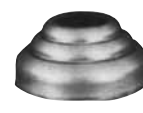

Base Ø 80 mm.
Art. 13.338 Ø Foro 30,5 mm.
Art. 13.339 Ø Foro 35,5 mm.
Art. 13.340 Ø Foro 40,5 mm.

Base Ø 60 mm.
Art. 13.341 Ø Foro 25,5 mm.
Art. 13.342 Ø Foro 30,5 mm.

Base Ø 50 mm.
Art. 13.343 Ø Foro 16,5 mm.
Art. 13.344 Ø Foro 18,5 mm.
Art. 13.345 Ø Foro 20,5 mm.

Base Ø 40 mm.
Art. 13.346 Ø Foro 12,5 mm.
Art. 13.347 Ø Foro 14,5 mm.
Art. 13.348 Ø Foro 16,5 mm.

Base Ø 30 mm.
Art. 13.349 Ø Foro 12,5 mm.
Art. 13.350 Foro ovale 12,5 mm.



H.1000 □ 16 mm.
Art. 13.350.01
 H.1000 □ 20 mm.
Art. 13.350.02

Elementi in Ottone / Brass Studs



H.250 mm. □ 14 mm.
Art. 13.350.03
 H.250 mm. □ 16 mm.
Art. 13.350.04



H.250 mm. □ 16 mm.
Art. 13.350.05
 H.250 mm. □ 20 mm.
Art. 13.350.06



H. 110 X L. 55 mm.
Art. 13.351
 Base Ø 34 mm.
 (filettato MA 8)

H. 120 X L. 60 mm.
Art. 13.352
 Base Ø 40 mm.
 (filettato MA 10)



H. 63 X L. 42 mm.
Art. 13.353
 Base Ø 30 mm.
 (filettato MA 8)



H. 70 X L. 40 mm.
Art. 13.356
 Base Ø 25 mm.
 (filettato MA 8)

H. 95 X L. 45 mm.
Art. 13.357
 Base Ø 38 mm.
 (filettato MA 10)

H. 110 X L. 55 mm.
Art. 13.358
 Base Ø 40 mm.
 (filettato MA 10)



Art. 13.359
 Sfera Ø 35 mm.
 Foro Ø 14 mm.

Art. 13.360
 Sfera Ø 45 mm.
 Foro Ø 14 mm.

Art. 13.361
 Sfera Ø 55 mm.
 Foro Ø 14 mm.



Art. 13.362
 Sfera Ø 45 mm.
 Foro □14 mm.

Art. 13.363
 Sfera Ø 55 mm.
 Foro □14 mm.

Fissaggio con granello
 Fastening with dowel
 Foro passante
 Passing hole

Tutte le parti di questo catalogo - foto comprese - sono di proprietà Euro-Fer. La riproduzione, anche parziale, è vietata in ogni forma e con ogni mezzo. / Every part of this catalogue - photos included - is Euro-Fer's property. All forms of copying are strictly prohibited.

Fissaggio con granello / Fastening with dowel



Sfera vuota filettata internamente
Internally-threaded empty sphere

- H.46 mm. MA 10
Art. 13.386 Ø 45 mm.
- H.72 mm. MA 10
Art. 13.389 Ø 75 mm.
- H.83 mm. MA 10
Art. 13.390 Ø 85 mm.
- H.120 mm. MA 10
Art. 13.392 Ø 120 mm.



H.45 X L.40 mm.
Art. 13.393
Foro Ø16 mm.



H.45 X L.40 mm.
Art. 13.394
Foro Ø16 mm.



H.105 X L.40 mm.
Art. 13.400 Foro Ø 12,5mm.
Art. 13.400.01 Foro Ø 14,5mm.
Art. 13.400.02 Foro Ø 16,5mm.



H.75 X L.40 mm.
Art. 13.401 Foro Ø 12,5mm.
Art. 13.401.01 Foro Ø 14,5mm.
Art. 13.401.02 Foro Ø 16,5mm.



H.30 X L.40 mm.
Art. 13.402 Foro Ø 12,5mm.
Art. 13.402.01 Foro Ø 14,5mm.
Art. 13.402.02 Foro Ø 16,5mm.

Borchie in ottone / Brass studs
Fissaggio con granello / Fastening with dowel

Distanziali regolabili / Adjustable support



Ferro zincato / Iron
H.23 - 33 mm
Art. 13.510 Ø 30 - foro10,5
H.23 - 33 mm
Art. 13.511 Ø 35 - foro14,5



Ferro zincato / Iron
H.30 - 40 mm
Art. 13.514 Ø 30 - foro14,5
H.30 - 40 mm
Art. 13.515 Ø 35 - foro14,5



Ferro zincato / Iron
H.32 - 42 mm
Art. 13.518 Ø 30 - foro10,5
H.32 - 42 mm
Art. 13.519 Ø 35 - foro14,5



Ferro zincato / Iron
H.45 - 65 mm
Art. 13.522 Ø 30 - foro14,5
H.45 - 65 mm
Art. 13.523 Ø 35 - foro14,5



Spessore 5 mm.
Art. 14.001 Ø 95 mm.



Spessore 4 mm.
Art. 14.002 Ø 95 mm.



Spessore 5 mm.
Art. 14.003 Ø 95 mm.



Spessore 3 mm.
Art. 14.003.01 Ø 68 mm.
Art. 14.003.02 Ø 97 mm.
Art. 14.003.03 Ø 120 mm.

NEW



Spessore 2 mm.
Art. 14.003.04 Ø 95 mm.



Spessore 4 mm.
Art. 14.004 Ø 63 mm.



Spessore 5 mm.
Art. 14.005 Ø 93 mm.



Spessore 0,8 mm.
Art. 14.005.01 Ø 77 mm.
Art. 14.005.02 Ø 111 mm.



H. 10 Spessore 0,8 mm
Art. 14.005.03 Ø 85 mm.
Foro Ø 10 mm.



H. 35 Spessore 2 mm
Art. 14.005.04 Ø 135 mm.
Foro Ø 11 mm.



H. 17 Spessore 0,5 mm
Art. 14.005.05 Ø 80 mm.
Foro Ø 10 mm.



Spessore 3 mm.
Art. 14.005.06 Ø 60 mm.
Foro Ø 10 mm.

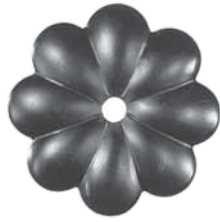

Spessore 3 mm.
Art. 14.005.07 Ø 90 mm.
Foro Ø 10 mm.



H.21 - Spessore 1 mm.
Art. 14.005.08 Ø 105 mm.
Foro Ø 10 mm.



H.10 - Spessore 10 mm.
Art. 14.005.09 Ø 65 mm.
Foro Ø 12,5 mm.



Spessore 3 mm.
Art. 14.006 Ø 65 mm.

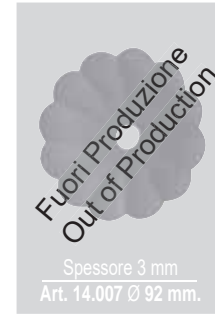

Spessore 3 mm
Art. 14.007 Ø 92 mm.



Spessore 3 mm.
Art. 14.008 Ø 118 mm.



Spessore 3 mm
Art. 14.010 Ø 98 mm.



Spessore 3 mm
Art. 14.011 Ø 122 mm.

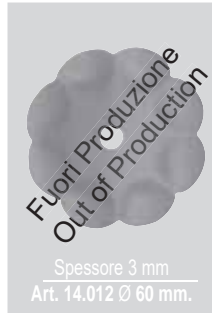

Spessore 3 mm
Art. 14.012 Ø 60 mm.



Spessore 3 mm
Art. 14.013 Ø 90 mm.



Spessore 3 mm.
Art. 14.014 Ø 60 mm.



Spessore 3 mm.
Art. 14.014.01 Ø 62 mm.

NEW



Spessore/Thickness 2,5 mm.
Art. 14.014.02 Ø 60

NEW



Spessore/Thickness 2,5 mm.
Art. 14.014.03 Ø 95

NEW



Spessore/Thickness 2,5 mm.
Art. 14.014.04 Ø 95



Spessore 3 mm.
Art. 14.015 Ø 95 mm.
Art. 14.015.01 Ø 120 mm.



Spessore 2 mm.
Art. 14.016 Ø 60 mm.



Spessore 2 mm.
Art. 14.017 Ø 60 mm.



Spessore 1 mm.
Art. 14.018 Ø 37 mm.



Spessore 5 mm.
Art. 14.018.01 Ø 60 mm.
Foro Ø 10 mm.



Spessore 3 mm
Art. 14.018.02 Ø 40 mm.



Spessore 2 mm.
Art. 14.019 Ø 60 mm.



Spessore 3 mm
Art. 14.019.01 Ø 65 mm.



Spessore 3 mm
Art. 14.019.02 Ø 60 mm.



Spessore 7 mm.
Art. 14.020 Ø 68 mm.



Spessore 2 mm.
Art. 14.021 Ø 90 mm.



Spessore 2 mm.
Art. 14.021.01 Ø 135 mm.
Foro Ø 10 mm.



Spessore 2 mm.
Art. 14.022 Ø 85 mm.



Spessore 2 mm.
Art. 14.023 Ø 85 mm.



H.40 - Spessore 0,5 mm.
Art. 14.024 Ø 40 mm.

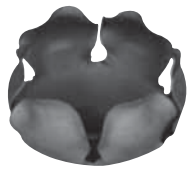

H.35 - Spessore 0,5 mm.
Art. 14.025 Ø 55 mm.

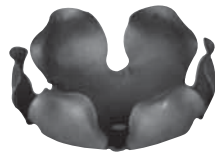

H.30 - Spessore 0,5 mm.
Art. 14.026 Ø 65 mm.

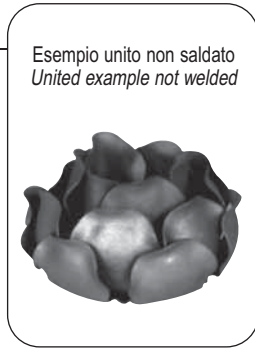

Esempio unito non saldato
United example not welded



H.50 mm. - Spessore 2 mm.
Art. 14.026.01 Ø 75 mm.
Foro Ø 10 mm.



H.70 mm. - Spessore 0,6 mm.
Art. 14.027 Ø 90 mm.

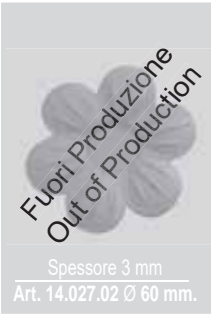

Spessore 3 mm
Art. 14.027.02 Ø 60 mm.



Spessore 2 mm
Art. 14.027.03 Ø 68 mm



Spessore 2 mm
Art. 14.027.04 Ø 95 mm



H. 42 - Spessore 0,6 mm.
Art. 14.030 Ø 40 mm.



Spessore 3 mm
Art. 14.032.01 Ø 130 mm.

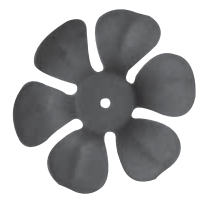

Spessore 0,6 mm.
Art. 14.034 Ø 65 mm.



Spessore 1 mm.
Art. 14.034.01 Ø 70 mm.

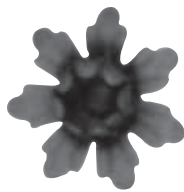

Spessore 0,5 mm.
Art. 14.035 Ø 42 mm.



Spessore 3 mm.
Art. 14.035.01 Ø 110 mm.



H 45 mm-Spessore 1,5 mm.
Art. 14.035.02 Ø 35 mm.



H 47 mm-Spessore 1,5 mm.
Art. 14.035.03 Ø 60 mm.



H 135 X L.80 mm
Art. 14.035.04

**FIORI E FOGLIE
FLOWERS AND LEAVES**



H 325 mm
Art. 14.035.05 Ø 6 mm.



H 325 mm
Art. 14.035.06 Ø 6 mm.



H 325 mm
Art. 14.035.07 Ø 6 mm.



H 325 mm
Art. 14.035.08 Ø 6 mm.



H 180 mm
Art. 14.035.09 Ø 3 mm.



H 180 X L.130 mm
Art. 14.035.10 Ø 3 mm.

NEW



H. 200 X L. 200 mm
Spessore/Thickness 4 mm.
Art. 14.035.11 Ø 200

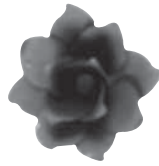

Spessore 0,5 mm.
Art. 14.036 Ø 48 mm.



Spessore 1 mm.
Art. 14.036.01 Ø 70 mm.



H. 45 X L.25 mm.
Art. 14.036.02
Spessore 0,5 mm.



H. 45 X L.30 mm.
Art. 14.036.03
Spessore 1,5 mm.



H. 70 X L.30 mm.
Art. 14.036.04
Spessore 0,5 mm.



H. 65 X L.55 mm.
Art. 14.036.05
Spessore 0,5 mm.



H. 115 X L.65 mm.
Art. 14.036.06
Spessore 0,5 mm.



H. 60 X L.50 mm.
Art. 14.036.07
Spessore 0,5 mm.



H. 55 X L.70 mm.
Art. 14.036.08
Spessore 1 mm.



H. 85 X L.45 mm.
Art. 14.037
Spessore 0,5 mm.



H. 83 X L.44 mm.
Art. 14.037.01
Spessore 1 mm.



H. 55 X L.31 mm.
Art. 14.037.02
Spessore 1 mm.



H. 70 X L.35 mm.
Art. 14.038
Spessore 0,5 mm.



H. 82 X L.47 mm.
Art. 14.038.01
Spessore 1 mm.



H. 195 X L.80 mm.
Art. 14.039
Spessore 0,5 mm.



H. 70 X L.78 mm.
Art. 14.039.01
Spessore 3 mm



H. 108 X L.120 mm.
Art. 14.039.02
Spessore 3 mm



H. 145 X L.160 mm.
Art. 14.039.03
Spessore 3 mm.



H. 57 X L.55 mm.
Art. 14.040
Spessore 0,6 mm.



H. 75 X L.70 mm.
Art. 14.041
Spessore 0,6 mm.



H. 105 X L.95 mm.
Art. 14.042
Spessore 1 mm.



H. 200 X L.190 mm.
Art. 14.043
Spessore 1 mm.



H. 130 X L.65 mm.
Art. 14.044
Spessore 1 mm.



H. 90 X L.45 mm.
Art. 14.045
Spessore 1 mm.



H. 240 X L. 70 mm.
Art. 14.046
Spessore 0,5 mm.



Tutte le parti di questo catalogo - foto comprese - sono di proprietà Euro-Fer. La riproduzione, anche parziale, è vietata in ogni forma e con ogni mezzo. / Every part of this catalogue - photos included - is Euro-Fer's property. All forms of copying are strictly prohibited.



H.175 mm.
Art. 14.046.01
Base 22 X 19 mm.



H. 170 X L.40 mm.
Art. 14.047
Spessore 0,5 mm.



H. 120 X L.40 mm.
Art. 14.048
Spessore 0,5 mm.



H. 294 X L.48 mm.
Art. 14.048.01
Spessore 1 mm.



H. 294 X L. 48 mm.
Art. 14.048.02
Spessore 1 mm.



H. 163 X L.30 mm.
Art. 14.048.03
Spessore 1 mm.



H. 60 X L.110 mm.
Art. 14.049
Spessore 1 mm.



H. 125 X L.175 mm.
Art. 14.050
Spessore 1 mm.



H.158 X L.80 mm.
Art. 14.050.01
Spessore 1 mm.



H.155X L.80 mm.
Art. 14.050.02
Spessore 1 mm.



H.27 - Spessore 1 mm.
Art. 14.050.03 Ø 150 mm.
Foro Ø 10,5 mm.



H.45 - Spessore 1 mm.
Art. 14.050.04 Ø 120 mm.
Foro Ø 12,5 mm.



H.200 X L.95 mm.
Art. 14.050.05
Spessore 1 mm.



H.230 X L.100 mm.
Art. 14.050.06
Spessore 1 mm.



H. 220 X L.140 mm.
Art. 14.051

H. 220 X L.140 mm.
Art. 14.052



H. 190 X L.140 mm.
Art. 14.053



H. 190 X L.140 mm.
Art. 14.054



H. 180 X L.130 mm.
Art. 14.055



H. 180 X L.130 mm.
Art. 14.056



H. 170 X L. 140 mm
Art. 14.057



H. 170 X L.140 mm.
Art. 14.058



H. 155 X L.60 mm.
Art. 14.059
H. 180 X L.65 mm.
Art. 14.059.01



H. 155 X L.60 mm.
Art. 14.060
H. 180 X L.65 mm.
Art. 14.060.01



H. 110 X L.40 mm.
Art. 14.061



H. 110 X L.40 mm.
Art. 14.062



H. 170 X L.140 mm.
Art. 14.057



H. 90 X L.30 mm.
Art. 14.063

H. 90 X L.30 mm.
Art. 14.064



H. 125 X L.75 mm.
Art. 14.065



H. 125 X L.75 mm.
Art. 14.066



H. 110 X L.105 mm.
Art. 14.067



H. 110 X L.105 mm.
Art. 14.068



H. 80 X L.60 mm.
Art. 14.069



H. 80 X L.60 mm.
Art. 14.070



H. 75 X L.80 mm.
Art. 14.071

H. 75 X L.80 mm.
Art. 14.072



H. 55 X L.70 mm.
Art. 14.073



H. 55 X L.70 mm.
Art. 14.074



H. 300 X L. 70 mm.
Art. 14.078.01
Spessore 4 mm.



H. 185 X L. 90 mm.
Art. 14.078.02
Spessore 10 mm.



H. 90 X L. 75 mm.
Art. 14.075



H. 90 X L. 75 mm.
Art. 14.076



H. 110 X L. 75 mm.
Art. 14.077



H. 215 X L. 110 mm.
Art. 14.079
Spessore 3 mm.



H. 205 X L. 100 mm.
Art. 14.080
Spessore 3 mm.



H. 165 X L. 70 mm.
Art. 14.081
Spessore 3 mm.



H. 125 X L. 82 mm.
Art. 14.082
Spessore 3 mm.



H. 140 X L. 85 mm.
Art. 14.083
Spessore 3 mm.



Base Ø 76 mm.
Art. 14.083.01
Spessore 20 mm.



Base Ø 90 mm.
Art. 14.083.02
Spessore 8 mm.
Base Ø 55 mm.
Art. 14.083.03
Spessore 8 mm.



H. 18 X L. 35 mm.
Art. 14.083.04



Base Ø 125 mm.
Art. 14.083.05
Spessore 15 mm.
Base Ø 90 mm.
Art. 14.083.06
Spessore 12 mm.
Base Ø 55 mm.
Art. 14.083.07
Spessore 8 mm.



H. 185 X L. 100 mm.
Art. 14.084
Spessore 10 mm.



H. 80 X L. 70 mm.
Art. 14.084.01
Spessore 3 mm.



H. 135 X L. 85 mm.
Art. 14.084.03 / Dx
Art. 14.084.05 / Sx
Spessore 3 mm.



H. 130 X L. 75 mm.
Art. 14.087
Spessore 5 mm.



Foglie Forgiate
Forged Leaves

H. 260 X L. 45 mm.
Art. 14.087.01
Spessore 5 mm. circa



Foglie Forgiate
Forged Leaves

H. 400 X L. 60 mm.
Art. 14.087.02
Spessore 8 mm. circa



Foglie Forgiate
Forged Leaves

H. 420 X L. 90 mm.
Art. 14.087.03
Spessore 8 mm. circa



Foglie Forgiate
Forged Leaves

H. 270 X L. 60 mm.
Art. 14.087.04
Spessore 8 mm. circa



H. 115 X L. 100 mm.
Art. 14.084.04 / Dx
Art. 14.084.06 / Sx
Spessore 3 mm.



H. 97 X L. 55 mm.
Art. 14.087.05
Spessore 4 mm



H. 90 X L. 55 mm.
Art. 14.087.06
Spessore 4 mm



H. 240 X L. 77 mm.
Art. 14.087.07
Spessore 4 mm



H. 225 X L. 60 mm.
Art. 14.087.08
Spessore 4 mm.



H. 190 X L. 45 mm.
Art. 14.087.09
Spessore 4 mm.



H.215 X L.150 mm.
Art. 14.087.10
Spessore 6 mm.



H.215 X L.150 mm.
Art. 14.087.11
Spessore 6 mm.



H.330 X L.260 mm.
Art. 14.087.12
Spessore 6 mm.



H.75 X L.125 mm.
Art. 14.087.13
Spessore 5 mm.



H.270 X L.150 mm.
Art. 14.087.14



H.250 X L.80 mm.
Art. 14.087.15

Decorazioni in Acciaio e Ottone / Brass and Steel Decorations

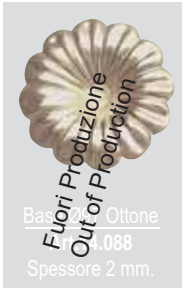

Base Ø 97 Acciaio
Art. 14.089
Spessore 1,5 mm.



H.80 X L.70 mm.
Art. 14.090
Ottone-Spessore 2 mm.



H.80 X L.70 mm.
Art. 14.091
Acciaio-Spessore 1,5 mm.



H.115 X L.100 mm.
Art. 14.092 Ottone-Sp. 2 mm./dx
Art. 14.092.01 Ottone-Sp. 2 mm./sx
Art. 14.093 Acciaio-Sp. 1,5 mm./dx
Art. 14.093.01 Acciaio-Sp. 1,5 mm./sx



H.135 X L.85 mm.
Art. 14.094 Ottone-Sp. 2 mm./dx
Art. 14.094.01 Ottone-Sp. 2 mm./sx
Art. 14.095 Acciaio-Sp. 1,5 mm./dx
Art. 14.095.01 Acciaio-Sp. 1,5 mm./sx



Base Ø 100 mm.
Art. 14.097 Acciaio-Sp. 1,5 mm.



H.90 X L.30 mm.
Art. 14.098 Ottone-Sp. 2 mm./dx
Art. 14.098.01 Ottone-Sp. 2 mm./sx
Art. 14.099 Acciaio-Sp. 1,5 mm./dx
Art. 14.099.01 Acciaio-Sp. 1,5 mm./sx



H.115X L.50 mm.
Art. 14.100 Ottone-Sp. 2 mm./dx
Art. 14.100.01 Ottone-Sp. 2 mm./sx
Art. 14.101 Acciaio-Sp. 1,5 mm./dx
Art. 14.101.01 Acciaio-Sp. 1,5 mm./sx



H.75X L.65 mm.
Art. 14.102 Ottone-Sp. 2 mm./dx
Art. 14.102.01 Ottone-Sp. 2 mm./sx
Art. 14.103 Acciaio-Sp. 1,5 mm./dx
Art. 14.103.01 Acciaio-Sp. 1,5 mm./sx



Filettato / Threaded MA 5.
H. 95 X L.95 mm.
Art. 14.106



Filettato / Threaded MA 4
H. 10 X Ø 40
Art.14.107



Filettato / Threaded MA 4
H.7 X Ø 38 mm.
Art. 14.108



Filettato / Threaded MA 4
H.7 X Ø 66 mm.
Art. 14.109



H.18 - Spessore 4 mm.
Art. 14.109.01 Ø 60 mm.
Foro/Hole Ø 6 mm.



Filettato / Threaded MA 6
Spessore 8 mm.
Art. 14.109.02 Ø 55 mm.



Filettato / Threaded MA 6
Spessore 13 mm.
Art. 14.109.03 Ø 78 mm.



Tutte le parti di questo catalogo - foto comprese - sono di proprietà Euro-Fer. La riproduzione, anche parziale, è vietata in ogni forma e con ogni mezzo. / Every part of this catalogue - photos included - is Euro-Fer's property. All forms of copying are strictly prohibited.

Decorazioni in Acciaio e Ottone Brass and Steel Decorations



Filettato / Threaded MA 6
H.85 X L.55mm.
Art. 14.109.04
Spessore/Thickness 4 mm.



Spessore 2 mm.
Art. 14.110 Ø 20 mm.
Art. 14.111 Ø 25 mm.
Art. 14.112 Ø 30 mm.
Art. 14.113 Ø 35 mm.
Art. 14.114 Ø 40 mm.
Art. 14.115 Ø 50 mm.
Art. 14.116 Ø 60 mm.

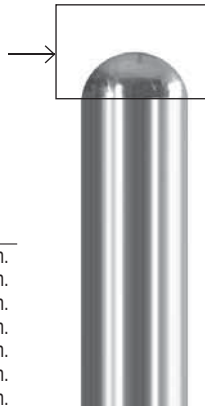

H.200 X L.70 mm.
Art. 14.151



H.200 X L.60 mm.
Art. 14.152



Filettato / Threaded MA 8
H.115 X L.58 mm.
Art. 14.118 Ø 20 mm
H.140 X L.70 mm. MA8
Art. 14.119 Ø 26 mm



Filettato / Threaded MA 8
H.150 X L.60 mm.
Art. 14.120 Ø 25 mm



H.180 X L.60 mm.
Art. 14.153



H. 250 X L.48 mm
Art. 14.160
Ø 6 mm





Gli articoli della Linea Liberty possono includere particolari in ghisa o ferro fuso.
The items of the Liberty Line could contain casting parts.



Sinistro / *Left*
H. 180 X L.150 mm.
Art. 14.200
Spessore 4 mm.



Destro / *Right*
H. 180 X L.150 mm.
Art. 14.201
Spessore 4 mm.



Sinistro / *Left*
H. 130 X L.55 mm.
Art. 14.202
Spessore 4 mm.



Destro / *Right*
H. 130 X L.55 mm.
Art. 14.203
Spessore 4 mm.



Sinistro / *Left*
H. 200 X L.150 mm.
Art. 14.204
Spessore 5 mm.
Base Ø 12



Destro / *Right*
H. 200 X L.150 mm.
Art. 14.205
Spessore 5 mm.
Base Ø 12.



Sinistro / *Left*
H. 115 X L.170 mm
Art. 14.206
Ø 12 mm



Destro / *Right*
H. 115 X L.170 mm
Art. 14.207
Ø 12 mm



Sinistro / *Left*
H. 190 X L.180 mm
Art. 14.208



Destro / *Right*
H. 190 X L.180 mm
Art. 14.209



Sinistro / *Left*
H. 130 X L.150 mm
Art. 14.210



Destro / *Right*
H. 130 X L.150 mm
Art. 14.211



Sinistro / *Left*
H. 175 X L.130 mm
Art. 14.212
Ø 12 mm



Destro / *Right*
H. 175 X L.130 mm
Art. 14.213
Ø 12 mm



Sinistro / *Left*
H. 235 X L.130 mm
Art. 14.214



Destro / *Right*
H. 235 X L.130 mm
Art. 14.215



Sinistro / *Left*
H. 90 X L.95 mm
Art. 14.216
Ø 12 mm



Destro / *Right*
H. 90 X L.95 mm
Art. 14.217
Ø 12 mm



Sinistro / *Left*
H. 135 X L.105 mm
Art. 14.218



Destro / *Right*
H. 135 X L.105 mm
Art. 14.219



Sinistro / Left
H. 160 X L.125 mm
Art. 14.220



Destro / Right
H. 160 X L.125 mm
Art. 14.221



Sinistro / Left
H. 110 X L.95 mm
Art. 14.222



Destro / Right
H. 110 X L.95 mm
Art. 14.223



Sinistro / Left
H. 100 X L.80 mm
Art. 14.224



Destro / Right
H. 100 X L.80 mm
Art. 14.225



Sinistro / Left
H. 80 X L.60 mm
Art. 14.226



Destro / Right
H. 80 X L.60 mm
Art. 14.227



Base 110 mm
Art. 14.250
Spessore 14 mm



Base 89 mm
Art. 14.251
Spessore 25 mm



Base 97 mm
Art. 14.252
Spessore 14 mm



H.140 X L.115 mm
Art. 14.253
Ø 12 mm



Base 50 mm
Art. 14.254
Spessore 3 mm



H.275 X L.88 mm
Art. 14.270
Spessore 3 mm



H.242 X L.70 mm
Art. 14.271
Spessore 3 mm





H. 175 X L.60 mm.
Art. 15.001
Spessore 10 mm.



H. 135 X L.45 mm.
Art. 15.002
Spessore 10 mm.



H. 165 X L.55 mm.
Art. 15.003
Spessore 10 mm.



Martellato / Hammered
Art. 15.003.01
≠ 30 X 8 mm.

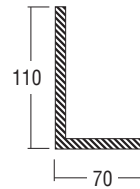

Martellato / Hammered
Art. 15.003.02
≠ 40 X 8 mm.



Martellato / Hammered
H. 300 X L.40 mm.
Art. 15.003.03
≠ 25 X 8 mm.



Martellato / Hammered
H. 300 X L.45 mm.
Art. 15.003.04
≠ 30 X 8 mm.



Martellato / Hammered
H. 300 X L.55 mm.
Art. 15.003.05
≠ 40 X 8 mm.



H. 180 X L.85 mm.
Art. 15.003.06 Ø 12 mm.



H. 180 X L.85 mm.
Art. 15.003.07 □ 10 mm.



H. 110 mm.
Art. 15.003.08 Ø 10 mm.

NEW

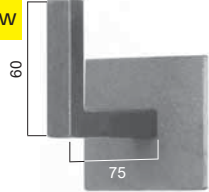

Piastra/Plate H.60 X 60 mm. ≠ 5 mm.
Art. 15.005.10 □ 12 mm.

NEW

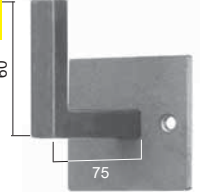

Piastra/Plate H.60 X 60 mm. ≠ 5 mm.
Art. 15.005.11 □ 12 mm.
forata / holed



H. 180 X L.95 mm.
Art. 15.004 □ 14 X 14 mm.

NEW



H.180 L.95 mm.
Art. 15.004.01 Ø 14 mm.



H. 120 X L.130 mm.
Art. 15.005 □ 14 X 14 mm.



H. 500 mm.
Art. 15.006.01 ≠ 80 X 8 mm.
Art. 15.006.02 ≠ 100 X 8 mm.
Art. 15.006.03 ≠ 120 X 8 mm.



H. 800 mm.
Art. 15.006.04 ≠ 80 X 8 mm.
Art. 15.006.05 ≠ 100 X 8 mm.
Art. 15.006.06 ≠ 120 X 8 mm.



H. 240 X L.140 mm.
Art. 15.006 □ 12 X 12 mm.



Martellato / Hammered
H. 300 mm.
Art. 15.006.13 □ 12 mm.

NEW



H. 420 X L. 270 mm.
Art. 15.006.14 ≠ 50 X 8 mm

NEW

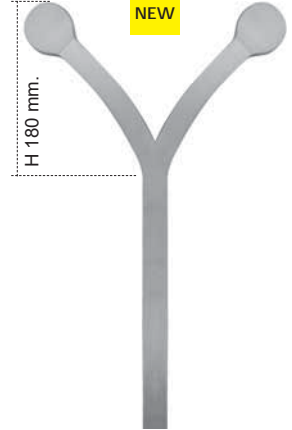

H. 180 mm.
Art. 15.006.15 □ 25 mm



H. 410 X L.195 mm.
Art. 15.007
□ 20 mm. ≙ 20 x 12

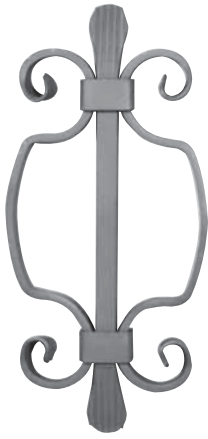

H. 410 X L.195 mm.
Art. 15.008
□ 20 mm. ≙ 20 x 8



H. 410 X L.165 mm.
Art. 15.009
□ 20 mm. ≙ 20 x 10

Foro / Hole Ø14



H. 130 X L.130 mm.
Art. 15.009.01
Spessore 12 mm.



Ø 112 mm.
Art. 15.009.02
Spessore 14 mm.



H. 300 mm.
Art. 15.010 □ 25 mm.
Art. 15.011 □ 30 mm.
Art. 15.012 □ 35 mm.
Art. 15.013 □ 40 mm.



H. 350 mm.
Art. 15.013.01 □ 25 mm.
Art. 15.013.02 □ 30 mm.
Art. 15.013.03 □ 35 mm.
Art. 15.013.04 □ 40 mm.



Martellato / *Hampered*
H. 350 mm.
Art. 15.013.05 □ 25 mm.
Art. 15.013.06 □ 30 mm.
Art. 15.013.07 □ 35 mm.
Art. 15.013.08 □ 40 mm.

Tondo / *Round*
H. 350 mm.
Art. 15.013.09 Ø 25 mm.
Art. 15.013.10 Ø 30 mm.
Art. 15.013.11 Ø 35 mm.
Art. 15.013.12 Ø 40 mm.

H. 350 mm.
Art. 15.013.13 □ 25 mm.
Art. 15.013.14 □ 30 mm.
Art. 15.013.15 □ 35 mm.
Art. 15.013.51 □ 40 mm.

Martellato / *Hampered*
H. 350 mm.
Art. 15.013.16 □ 25 mm.
Art. 15.013.17 □ 30 mm.
Art. 15.013.18 □ 35 mm.
Art. 15.013.52 □ 40 mm.

Tondo / *Round*
H. 350 mm.
Art. 15.013.19 Ø 25 mm.
Art. 15.013.20 Ø 30 mm.

H. 350 mm.
Art. 15.013.21 □ 25 mm.
Art. 15.013.22 □ 30 mm.

Martellato / *Hampered*
H. 350 mm.
Art. 15.013.23 □ 25 mm.
Art. 15.013.24 □ 30 mm.



Tondo / *Round*
H. 350 mm.
Art. 15.013.25 Ø 25 mm.
Art. 15.013.26 Ø 30 mm.

H. 350 mm.
Art. 15.013.27 □ 25 mm.
Art. 15.013.28 □ 30 mm.
Art. 15.013.29 □ 35 mm.
Art. 15.013.30 □ 40 mm.

Martellato / *Hampered*
H. 350 mm.
Art. 15.013.31 □ 25 mm.
Art. 15.013.32 □ 30 mm.
Art. 15.013.33 □ 35 mm.
Art. 15.013.34 □ 40 mm.

H. 350 mm.
Art. 15.013.35 □ 25 mm.
Art. 15.013.36 □ 30 mm.
Art. 15.013.37 □ 35 mm.
Art. 15.013.38 □ 40 mm.

Martellato / *Hampered*
H. 350 mm.
Art. 15.013.39 □ 25 mm.
Art. 15.013.40 □ 30 mm.
Art. 15.013.41 □ 35 mm.
Art. 15.013.42 □ 40 mm.

H. 360 mm.
Art. 15.013.45 □ 25 mm.
Art. 15.013.46 □ 30 mm.
Art. 15.013.47 □ 35 mm.

Martellato / *Hampered*
H. 360 mm.
Art. 15.013.48 □ 25 mm.
Art. 15.013.49 □ 30 mm.
Art. 15.013.50 □ 35 mm.



Martellato / Hammered
H. 350 mm
Art. 15.013.60 □ 25 mm
Art. 15.013.61 □ 30 mm

Liscio / Smooth
H. 350 mm
Art. 15.013.62 □ 25 mm
Art. 15.013.63 □ 30 mm
Art. 15.013.64 Ø 25 mm
Art. 15.013.65 Ø 30 mm

Martellato / Hammered
H. 300 mm.
Art. 15.014 □ 25 mm.
Art. 15.015 □ 30 mm.

Mod. Scala / Scala Model
H. 350 mm.
Art. 15.015.01 □ 25 mm.
Art. 15.015.02 □ 30 mm.

H. 350 mm.
Art. 15.015.03 □ 25 mm.
Art. 15.015.04 □ 30 mm.

Martellato / Hammered
H. 350 mm.
Art. 15.015.05 □ 25 mm.
Art. 15.015.06 □ 30 mm.

Tondo / Round
H. 350 mm.
Art. 15.015.07 Ø 25 mm.
Art. 15.015.08 Ø 30 mm.



Tondo Lavorato
Worked Round Bar
H. 350 mm.
Art. 15.015.09 Ø 25 mm.
Art. 15.015.10 Ø 30 mm.

Martellato / Hammered
H. 300 mm.
Art. 15.016 □ 25 mm.
Art. 15.017 □ 30 mm.
Art. 15.017.01 □ 35 mm.
Art. 15.017.02 □ 40 mm.
Art. 15.017.03 □ 25 mm. Liscio/Smooth
Art. 15.017.04 □ 30 mm. Liscio/Smooth
Art. 15.017.05 □ 35 mm. Liscio/Smooth
Art. 15.017.06 □ 40 mm. Liscio/Smooth

Mod. Scala / Scala Model
H. 350 mm.
Art. 15.017.07 □ 25 mm.
Art. 15.017.08 □ 30 mm.
Art. 15.017.09 □ 35 mm.

H. 350 mm.
Art. 15.017.10
≠ 30 x 20

Martellato / Hammered
H. 350 mm.
Art. 15.017.11
≠ 30 x 20

Martellato / Hammered
H. 350 mm.
Art. 15.017.12 □ 25 mm.
Liscio / Smooth
H. 350 mm.
Art. 15.017.13 □ 25 mm.



Tutte le parti di questo catalogo - foto comprese - sono di proprietà Euro-Fer. La riproduzione, anche parziale, è vietata in ogni forma e con ogni mezzo. / Every part of this catalogue - photos included - is Euro-Fer's property. All forms of copying are strictly prohibited.

**CIMASE, TERMINALI ED ELEMENTI VARI
ORNAMENTS FOR CARRIAGE GATES AND VARIOUS ELEMENTS**



H. 300 mm.
Art. 15.018
≠ 70 X 6 mm.
Art. 15.018.50
≠ 50 X 6 mm.
Art. 15.018.51
≠ 60 X 6 mm.
Art. 15.018.52
≠ 80 X 6 mm.



Mod. Scala / Scala Model
H. 350 mm.
Art. 15.018.01
≠ 60 X 8 mm.



H. 350 mm.
Art. 15.018.02
≠ 40 X 6 mm.
Art. 15.018.03
≠ 50 X 6 mm.



H. 300 mm.
Art. 15.018.04
≠ 40 X 6 mm.
Art. 15.018.05
≠ 50 X 6 mm.
Art. 15.018.06
≠ 60 X 6 mm.



H. 350 mm.
Art. 15.018.07
≠ 50 X 8 mm.



Martellato / Hammered
H. 350 mm.
Art. 15.018.08
≠ 50 X 8 mm.



H. 350 mm.
Art. 15.018.09
≠ 50 X 10 mm.

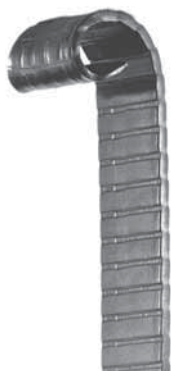

Mod. Scala / Scala Model
H. 350 mm.
Art. 15.018.10
≠ 60 X 8 mm.



Battuto / Beaten
H. 350 mm.
Art. 15.018.11
≠ 60 X 8 mm.



H. 300 mm.
Art. 15.019
≠ 70 X 6 mm.

**Ribattini Martellati
Hammered-Head Rivets**

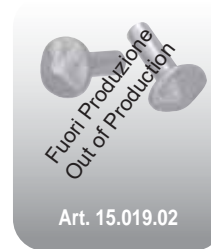

H. 60 X L. 100 mm.
Art. 15.021.03
Spessore 35 mm.



H. 60 X L. 60 mm.
Art. 15.021.04
Spessore 40 mm.



H. 35 mm.- Ø 100 mm
Art. 15.021.08
Spessore 12 mm.



L. 105 mm
≠ 40 x 8 mm
Art. 15.021.50
foro/hole Ø 35 x 17 mm

**Chiodi di Ferro
Iron Nails**



Art. 15.019.23 H. 230 □ 10 mm.
Art. 15.019.27 H. 270 □ 10 mm.
Art. 15.019.30 H. 300 □ 10 mm.

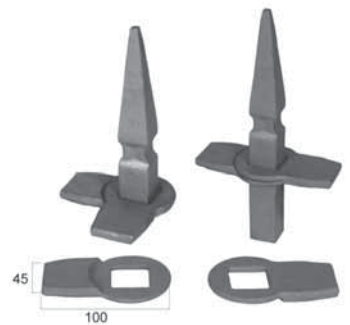

Spessore 10 mm.
Art. 15.021
□ Foro 32 mm.

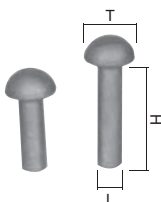

Art. 15.022 L. 6 X H. 20 T. 11/12 mm.
Art. 15.023 L. 6 X H. 25 T. 11/12 mm.
Art. 15.024 L. 6 X H. 30 T. 11/12 mm.
Art. 15.025 L. 6 X H. 35 T. 11/12 mm.
Art. 15.026 L. 6 X H. 40 T. 11/12 mm.
Art. 15.027 L. 6 X H. 45 T. 11/12 mm.
Art. 15.028 L. 6 X H. 50 T. 11/12 mm.

Art. 15.029 L. 8 X H. 20 T. 13/14 mm.
Art. 15.030 L. 8 X H. 25 T. 13/14 mm.
Art. 15.031 L. 8 X H. 30 T. 13/14 mm.
Art. 15.032 L. 8 X H. 35 T. 13/14 mm.
Art. 15.033 L. 8 X H. 40 T. 13/14 mm.
Art. 15.034 L. 8 X H. 45 T. 13/14 mm.
Art. 15.035 L. 8 X H. 50 T. 13/14 mm.

Art. 15.036 L. 10 X H. 25 T. 17 mm.
Art. 15.037 L. 10 X H. 30 T. 17 mm.
Art. 15.038 L. 10 X H. 35 T. 17 mm.
Art. 15.039 L. 10 X H. 40 T. 17 mm.
Art. 15.040 L. 10 X H. 45 T. 17 mm.
Art. 15.041 L. 10 X H. 50 T. 17 mm.

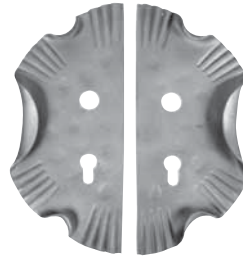
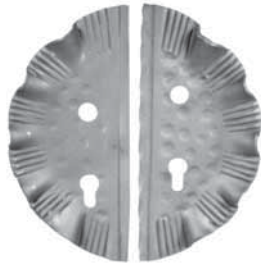
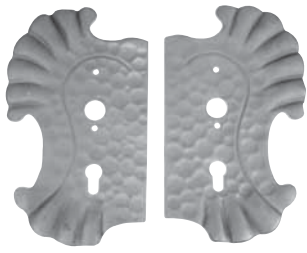

H. 275 X L.160 mm.

H. 275 X L.160 mm.

H. 260 X L.115 mm.

H. 260 X L.115 mm.

H. 295 X L.130 mm.

H. 295 X L.130 mm.

H. 230 X L.80 mm.

H. 300 X L.105 mm.

Art. 15.042

Art. 15.043

Art. 15.044

Art. 15.045

Art. 15.046

Art. 15.047

Art. 15.048

Art. 15.049

Spessore 3 mm.

Spessore 3 mm.

Spessore 3 mm.

Spessore 3 mm.

Spessore 3 mm.

Spessore 3 mm.

Spessore 6 mm.

Spessore 6 mm.

Art. 15.042.01
Senza Foro
Without Hole

Art. 15.043.01
Senza Foro
Without Hole

Art. 15.044.01
Senza Foro
Without Hole

Art. 15.045.01
Senza Foro
Without Hole

Art. 15.046.01
Senza Foro
Without Hole

Art. 15.047.01
Senza Foro
Without Hole

SUPPORTI PER MENSOLE
SUPPORTS FOR SHELVES
colore nero / black colour

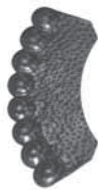

H.200 x L.90 mm
Art. 15.049.10
≠ 3 mm

H. 200 X L.160 mm.
Art. 15.050
≠ 20 X 4

H. 155 X L.125 mm.
Art. 15.050.01

H. 225 X L.175 mm.
Art. 15.050.02

H. 280 X L.220 mm.
Art. 15.050.03

Copricolonna saldati e molati
Post caps welded and grinded

Copricolonna puntati in lamierino
Post caps in iron sheet



Art. 15.059.001 H. 40 x 40 mm
Art. 15.059.002 H. 50 x 50 mm
Art. 15.059.003 H. 60 x 60 mm
Art. 15.059.004 H. 70 x 70 mm
Art. 15.059.005 H. 80 x 80 mm
Art. 15.059.006 H. 100 x 100 mm
Art. 15.059.007 H. 120 x 120 mm
Art. 15.059.008 H. 150 x 150 mm

Art. 15.059.02 H.150 X L.150
Art. 15.059.03 H.120 X L.120
Art. 15.059.04 H.100 X L.100

Fuori Produzione
Out of Production
Art. 15.051

Copricolonna
Post Caps

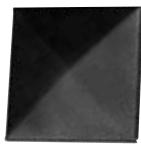

Art. 15.052 □ 30 X 30
Art. 15.053 □ 40 X 40
Art. 15.054 □ 50 X 50
Art. 15.055 □ 60 X 60
Art. 15.056 □ 80 X 80
Art. 15.057 □ 100 X 100
Art. 15.058 □ 120 X 120
Art. 15.059 □ 150 X 150

Si raccomanda di zincare a caldo le sfere vuote in lamiera solo dopo averle forate
It's recommended to perforate the Hollow Spheres before the hot galvanization



Sfera vuota / Hollow sphere

Art. 15.059.05 □ 30x30 Ø 40 mm

Art. 15.059.06 □ 40x40 Ø 40 mm

Art. 15.059.07 □ 50x50 Ø 50 mm

Sfera vuota / Hollow sphere

Art. 15.059.08 □ 60x60 Ø 60 mm

Art. 15.059.09 □ 80x80 Ø 80 mm

Art. 15.059.10 □ 100x100 Ø 100 mm



Ruota leggera mod. T gola tonda
Light mod. T wheel-round groove

Art. 15.060 60 X 20 mm.
Art. 15.062 80 X 20 mm.
Art. 15.063 100 X 20 mm.
Art. 15.064 120 X 20 mm.
Art. 15.065 140 X 20 mm.

Ruota leggera mod. T a "V"
Light mod. T wheel-"V" shaped

Art. 15.072 60 X 20 mm.
Art. 15.074 80 X 20 mm.
Art. 15.075 100 X 20 mm.
Art. 15.076 120 X 20 mm.
Art. 15.077 140 X 20 mm.

Ruota pesante mod. T gola tonda
Heavy mod. T wheel-round groove

Art. 15.067 100 X 30 mm.
Art. 15.068 120 X 30 mm.
Art. 15.069 140 X 30 mm.
Art. 15.070 160 X 30 mm.

Ruota pesante mod. T a "V"
con doppio cuscinetto
Heavy mod. T wheel-"V" shaped
double bearing

Art. 15.079 100 X 30 mm.
Art. 15.080 120 X 30 mm.
Art. 15.081 140 X 30 mm.

Ruota con piastra a saldare gola tonda mod. T
Mod. "T" wheel with plate to weld-round groove

Art. 15.084 120 X 20 mm.
Art. 15.086 120 X 30 mm.



Ruota con piastra a saldare a "V" mod. T
Mod. T wheel with plate to weld-"V" shaped

Art. 15.088 120 X 20 mm.
Art. 15.091 140 X 30 mm.

Ruota a supporto interno mod. T gola tonda
Mod. T wheel with internal support-round groove

Art. 15.092 120 X 20 mm.
Art. 15.093 140 X 20 mm.
Art. 15.094 120 X 30 mm.
Art. 15.095 140 X 30 mm.



Ruota a supporto interno mod. T a "V"
Mod. T wheel with internal support-"V" shaped

Art. 15.096 120 X 20 mm.

**CIMASE, TERMINALI ED ELEMENTI VARI
ORNAMENTS FOR CARRIAGE GATES AND VARIOUS ELEMENTS**



Cardine a barra lunga
Long bar hinge
Zincato / Zinc-Plated
Art. 15.102 Ø 18 MA
Art. 15.103 Ø 22 MA



Cardine a muro
Hinge wall
Zincato / Zinc-Plated
Art. 15.107 Ø 18 MA
Art. 15.108 Ø 22 MA
Art. 15.109 Ø 27 MA



Cardine a saldare
Hinge -Welding hinge
Zincato / Zinc-Plated
Art. 15.113 Ø 18 MA
Art. 15.114 Ø 22 MA
Art. 15.115 Ø 27 MA



Cardine a regolazione ortogona-
nale (con vite a perno zincati)
Right-angle adjustment hinge
(whit galvanized screw and pin)
Art. 15.116 Ø 18 MA
Art. 15.117 Ø 22 MA
Art. 15.118 Ø 27 MA



Zincato / Zinc-Plated
Art. 15.122 H.15 X L.60 mm.
Art. 15.123 H.20 X L.70 mm.
Art. 15.124 H.20 X L.80 mm.



Zincato / Zinc-Plated
Art. 15.128 H. 89 mm. Ø 20 mm.
Art. 15.129 H. 98 mm. Ø 23mm.
Art. 15.130 H.105 mm. Ø 28 mm.



Zincato / Zinc-Plated
Art. 15.131 Cardine 18 MA per □30 - piastra 90 X 90 X 4
Art. 15.132 Cardine 22 MA per □35 - piastra 110 X 110 X 5
Art. 15.133 Cardine 27 MA per □40 - piastra 130 X 130 X 5



Zincato / Zinc-Plated
Art. 15.134 Cardine 18 MA regolabile per □30 - piastra 90 X 90 X 4
Art. 15.135 Cardine 22 MA regolabile per □35 - piastra 110 X 110 X 5
Art. 15.136 Cardine 27 MA regolabile per □40 - piastra 130 X 130 X 5

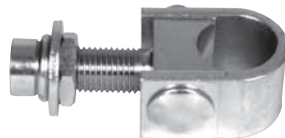

Zincato / Zinc-Plated
Art. 15.137 Cardine 18 MA regolabile per □30
Art. 15.138 Cardine 22 MA regolabile per □35
Art. 15.139 Cardine 27 MA regolabile per □40

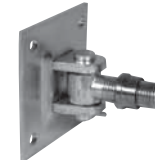

Zincato / Zinc-Plated
Art. 15.140 Cardine 18 MA con orecchie saldate su piastra 90 X 90 X 4
Art. 15.141 Cardine 22 MA con orecchie saldate su piastra 110 X 110 X 5
Art. 15.142 Cardine 27 MA con orecchie saldate su piastra 130 X 130 X 5

Accessori per cancelli in ferro battuto /

Perni di collegamento e guida superiore
Connection pins and upper guide

Accessories for wrought iron gates

Perni di collegamento e guida inferiore
Connection pins and lower guide



Art. 15.143
Perno sup. per cardine
Ø 24 per tub. □30X 3



Art. 15.146
Perno sup. per cardine
Ø 30 per ■30X 3



Art. 15.147
Perno sup. per cardine
Ø 35 per ■35X 3

Art. 15.149
Perno inf. per cardine
Ø 19 A

Art. 15.144
Perno sup. per cardine
Ø 29 per tub. □35X 3

Art. 15.148
Perno sup. per cardine
Ø 40 per ■40X 3

Art. 15.150
Perno inf. per cardine
Ø 22A

Cerniere con cuscinetti a sfere
Hinge with ball bearings



Art. 15.151.05
H. 185 mm.
Art. 15.151.06
Ø 28 mm.



H. 80 mm.
Art. 15.151.01
Ø 12 mm.
H. 140 mm.
Art. 15.151.02
Ø 16,5 mm.



H. 100 mm.
Art. 15.151.03
Ø 13,5 mm.
H. 140 mm.
Art. 15.151.04
Ø 16,5 mm.



H. 100 mm.
Art. 15.151.07
Ø 20 mm.



H. 120 mm.
Art. 15.151.08
Ø 24 mm.



H. 145 mm.
Art. 15.151.09
Ø 30 mm.



H. 200 mm.
Art. 15.151.10
Ø 30 mm.

Tutti i Fori sono Ø 11 / All Holes Ø 11

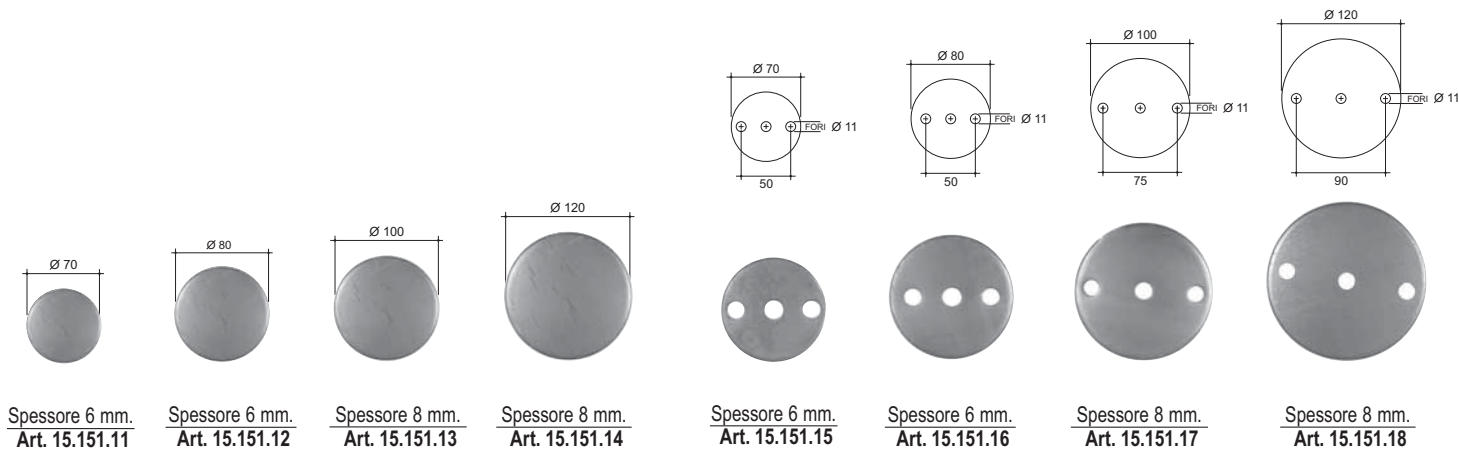

Spessore 6 mm.
Art. 15.151.11

Spessore 6 mm.
Art. 15.151.12

Spessore 8 mm.
Art. 15.151.13

Spessore 8 mm.
Art. 15.151.14

Spessore 6 mm.
Art. 15.151.15

Spessore 6 mm.
Art. 15.151.16

Spessore 8 mm.
Art. 15.151.17

Spessore 8 mm.
Art. 15.151.18

Tutti i Fori sono Ø 11 / All Holes Ø 11

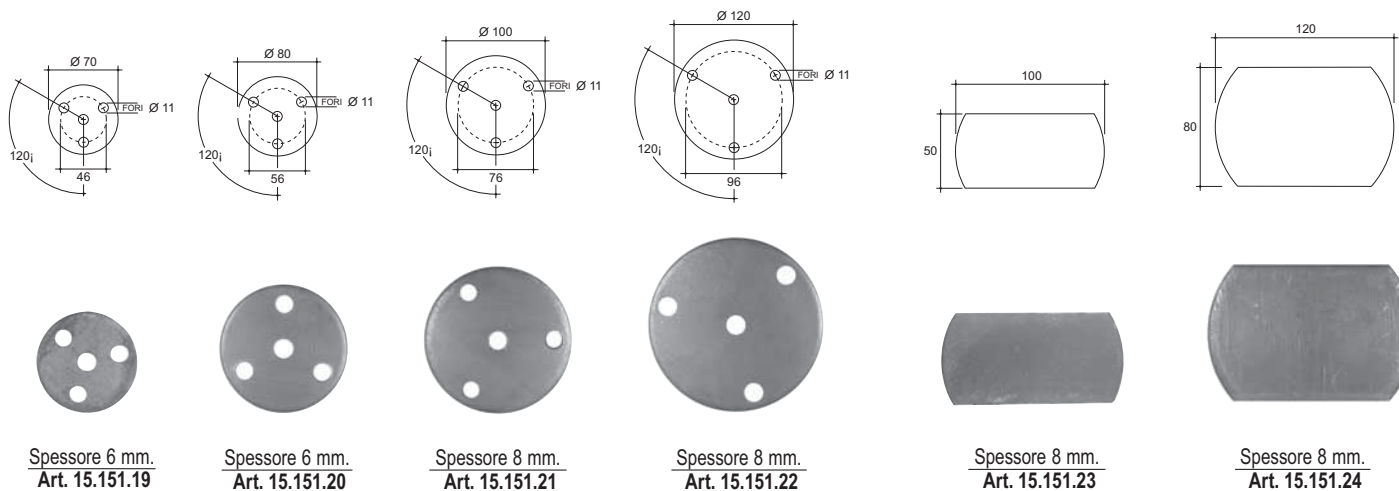

Spessore 6 mm.
Art. 15.151.19

Spessore 6 mm.
Art. 15.151.20

Spessore 8 mm.
Art. 15.151.21

Spessore 8 mm.
Art. 15.151.22

Spessore 8 mm.
Art. 15.151.23

Spessore 8 mm.
Art. 15.151.24

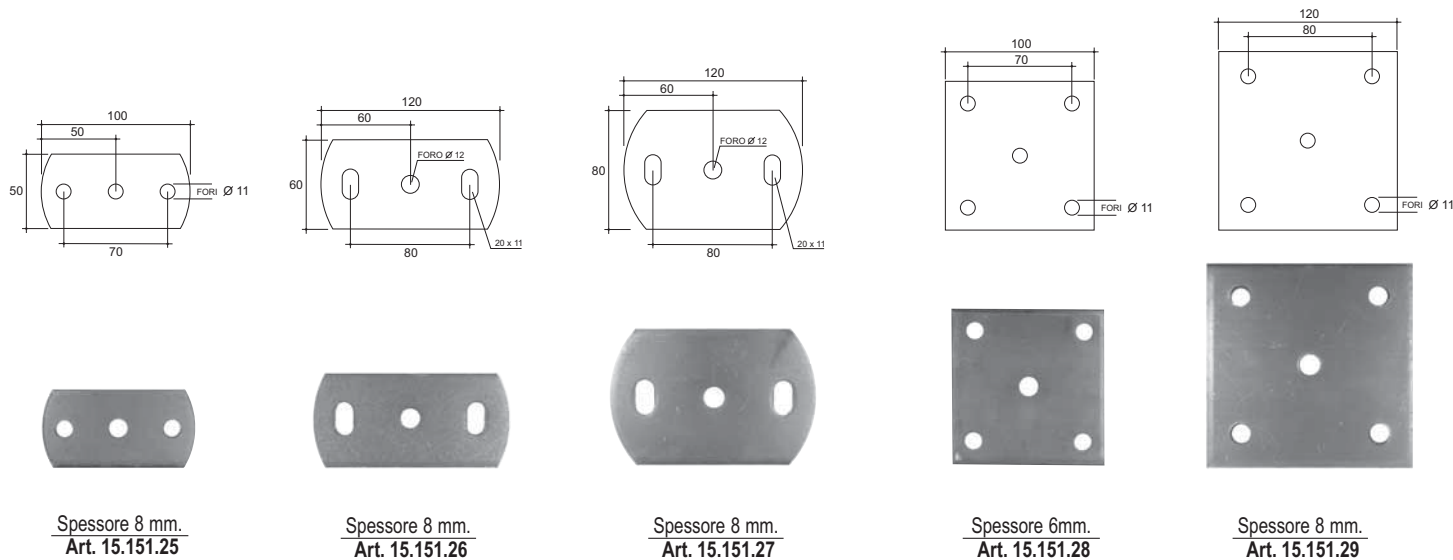

Spessore 8 mm.
Art. 15.151.25

Spessore 8 mm.
Art. 15.151.26

Spessore 8 mm.
Art. 15.151.27

Spessore 6 mm.
Art. 15.151.28

Spessore 8 mm.
Art. 15.151.29

Articoli forniti in coppia / These pieces are furnished in pair

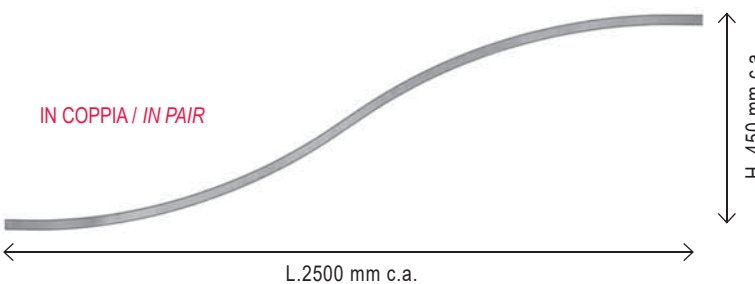
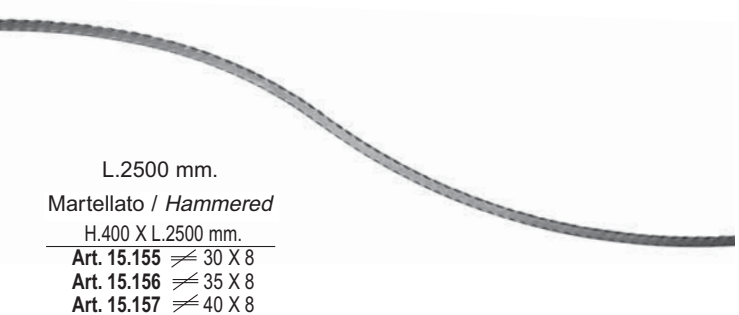
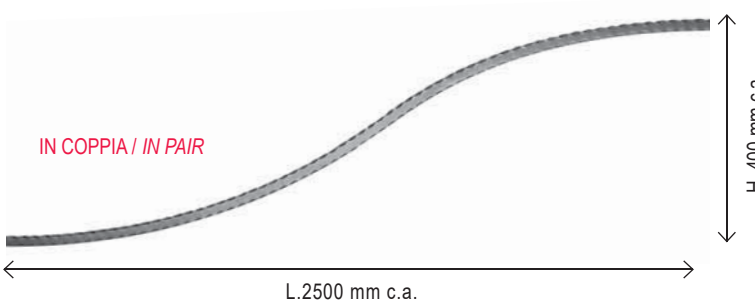
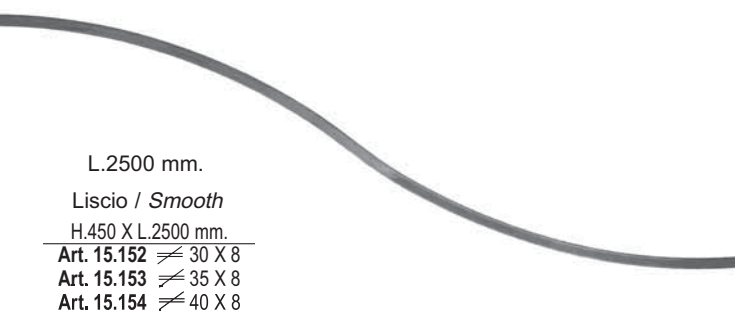
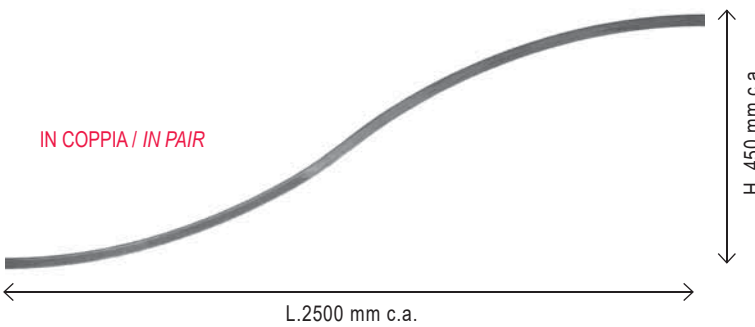
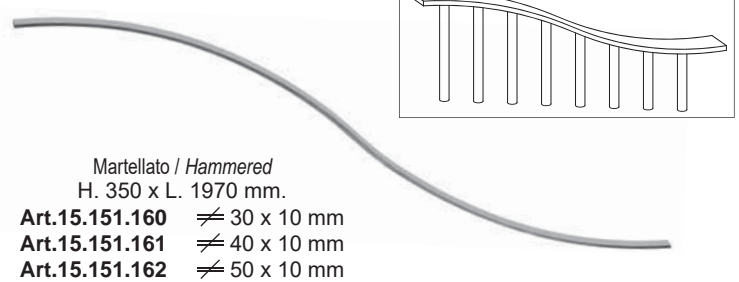
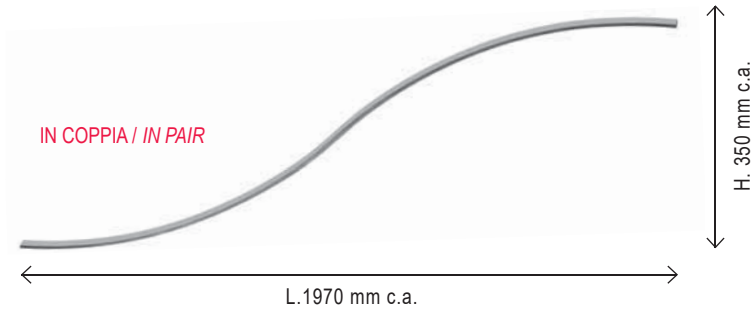
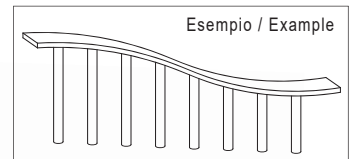
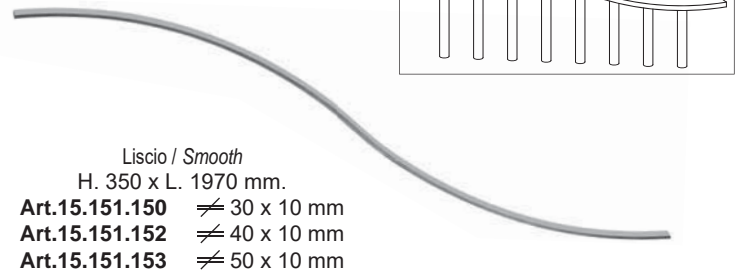
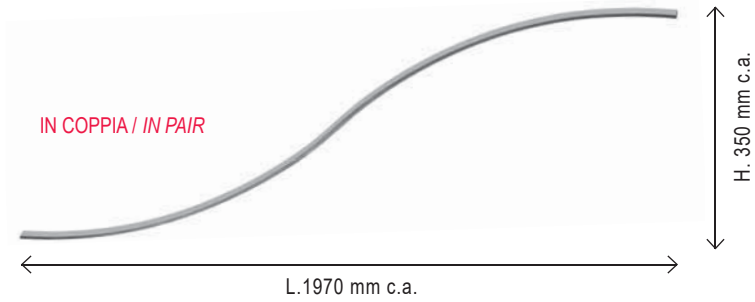
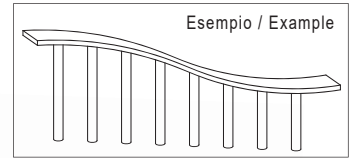

Articoli forniti in coppia / These pieces are furnished in pair

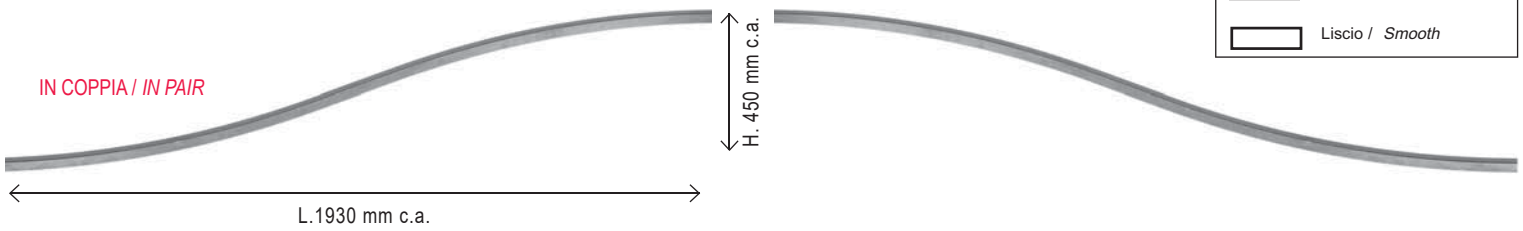

Tubolare Martellato / *Hammered Bars*

L.1930 mm. H. 450 mm.	
Art. 15.157.04	30 X 30
Art. 15.157.05	40 X 20

Tubolare Liscio / *Smooth Bars*

L.1930 mm. H. 450 mm.	
Art. 15.157.02	30 X 30
Art. 15.157.03	40 X 20

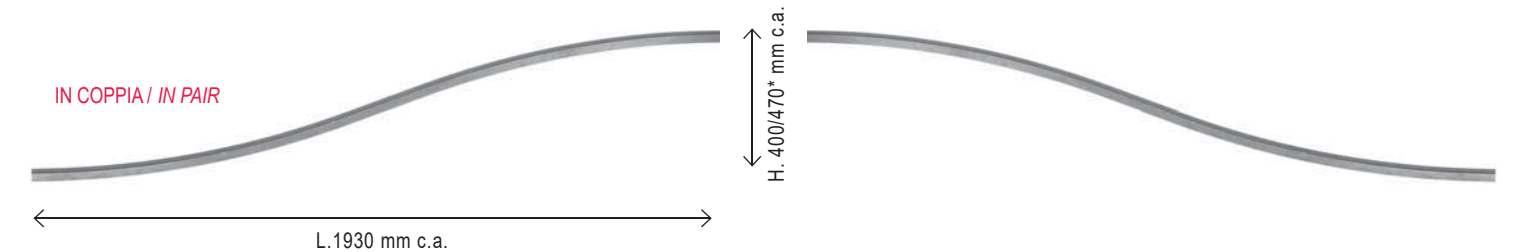

Martellato / *Hammered*

L.1930 mm. H. 400 mm.*	
Art. 15.157.06	30 X 8
Art. 15.157.08	35 X 8
Art. 15.157.10	40 X 8

Sagomato / *Modelled*

L.1930 mm. H. 470 mm.*	
Art. 15.157.12	30 X 8

Liscio / *Smooth*

L.1930 mm. H. 470 mm.*	
Art. 15.157.14	30 X 8
Art. 15.157.15	35 X 8
Art. 15.157.16	40 X 8

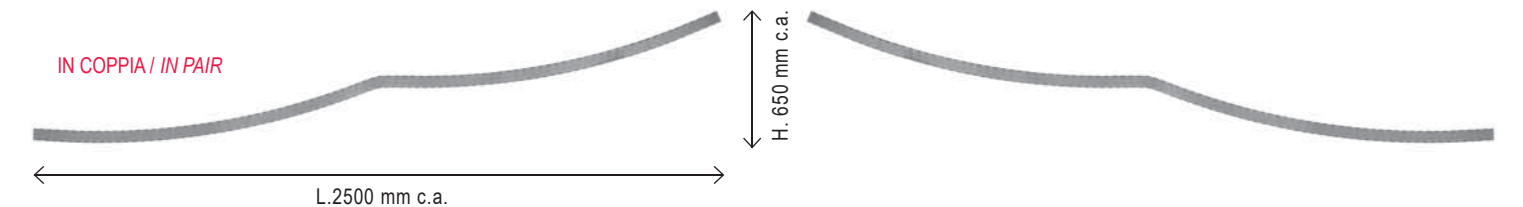

Martellato / *Hammered*

L.2500 mm.	
Art. 15.157.17	30 X 8
Art. 15.157.18	35 X 8
Art. 15.157.19	40 X 8

Sagomato / *Modelled*

L.2500 mm.	
Art. 15.157.20	30 X 8

Liscio / *Smooth*

L.2500 mm.	
Art. 15.157.21	30 X 8
Art. 15.157.22	35 X 8
Art. 15.157.23	40 X 8

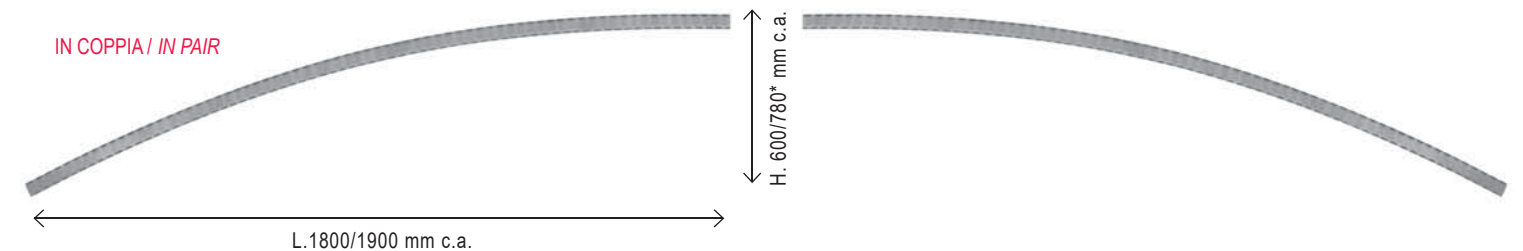

Martellato / *Hammered*

L. 1900 mm. H. 600 mm.*	
Art. 15.157.24	30 X 8
Art. 15.157.25	35 X 8
Art. 15.157.26	40 X 8

Fuori Produzione
Out of Production

Mod. Scala / *Scala Model*

L. 1800 mm. H. 780 mm.*	
Art.15.157.27	30 x 8 mm
Art.15.157.28	35 x 8 mm
Art.15.157.29	40 x 8 mm

Liscio / *Smooth*

L.1800 mm. H. 780 mm.*	
Art. 15.157.30	30 X 8
Art. 15.157.31	35 X 8
Art. 15.157.32	40 X 8

Tutte le parti di questo catalogo - foto comprese - sono di proprietà Euro-Fer. La riproduzione, anche parziale, è vietata in ogni forma e con ogni mezzo. / Every part of this catalogue - photos included - is Euro-Fer's property. All forms of copying are strictly prohibited.

**CIMASE, TERMINALI ED ELEMENTI VARI
ORNAMENTS FOR CARRIAGE GATES AND VARIOUS ELEMENTS**

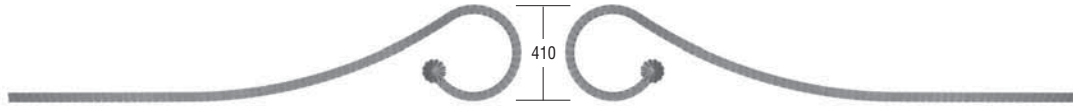

Sinistro / *Left*
Martellato / *Hammered*
L.2150 mm.
Art. 15.157.33 ≙ 30 X 8
Art. 15.157.35 ≙ 35 X 8
Art. 15.157.37 ≙ 40 X 8

Sinistro / *Left*
Liscio / *Smooth*
L.2150 mm.
Art. 15.157.39 ≙ 30 X 8
Art. 15.157.41 ≙ 35 X 8
Art. 15.157.43 ≙ 40 X 8

Destro / *Right*
Martellato / *Hammered*
L.2150 mm.
Art. 15.157.34 ≙ 30 X 8
Art. 15.157.36 ≙ 35 X 8
Art. 15.157.38 ≙ 40 X 8

Destro / *Right*
Liscio / *Smooth*
L.2150 mm.
Art. 15.157.40 ≙ 30 X 8
Art. 15.157.42 ≙ 35 X 8
Art. 15.157.44 ≙ 40 X 8



Sinistro / *Left*
Martellato / *Hammered*
L.2000 mm.
Art. 15.157.45 ≙ 30 X 8
Art. 15.157.47 ≙ 35 X 8
Art. 15.157.49 ≙ 40 X 8

Liscio / *Smooth*
L.2000 mm.
Art. 15.157.51 ≙ 30 X 8
Art. 15.157.52 ≙ 35 X 8
Art. 15.157.53 ≙ 40 X 8

Destro / *Right*
Martellato / *Hammered*
L.2000 mm.
Art. 15.157.46 ≙ 30 X 8
Art. 15.157.48 ≙ 35 X 8
Art. 15.157.50 ≙ 40 X 8

N.B.: Nel piatto liscio
sinistro o destro sono uguali.
Note: Right and left sides are equal in
smooth flat sections.

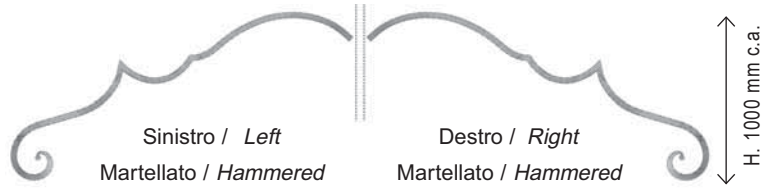

Sinistro / *Left*
Martellato / *Hammered*
L.2000 mm.
Art. 15.157.54 ≙ 35 X 8
Art. 15.157.56 ≙ 40 X 8

Liscio / *Smooth*
L.2000 mm.
Art. 15.157.58 ≙ 35 X 8
Art. 15.157.59 ≙ 40 X 8

Destro / *Right*
Martellato / *Hammered*
L.2000 mm.
Art. 15.157.55 ≙ 35 X 8
Art. 15.157.57 ≙ 40 X 8

N.B.: Nel piatto liscio
sinistro o destro sono uguali.
Note: Right and left sides are equal in
smooth flat sections.



CIMASE, TERMINALI ED ELEMENTI VARI ORNAMENTS FOR CARRIAGE GATES AND VARIOUS ELEMENTS

N.B.: Nel piatto liscio
sinistro o destro sono uguali.
Note: Right and left sides are equal in
smooth flat sections.

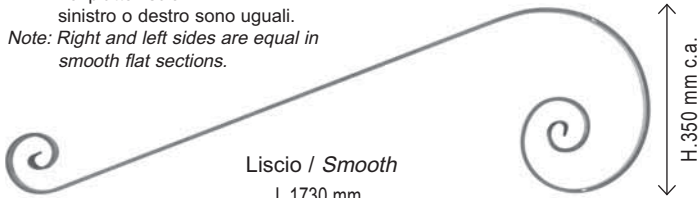

Liscio / Smooth
L.1730 mm.
Art. 15.157.60 ≙ 30 X 8
Art. 15.157.61 ≙ 35 X 10
Art. 15.157.62 ≙ 40 X 8

H.350 mm c.a.

N.B.: Nel piatto liscio
sinistro o destro sono uguali.
Note: Right and left sides are equal in
smooth flat sections.

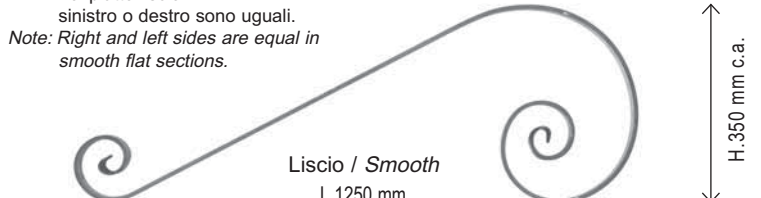

Liscio / Smooth
L.1250 mm.
Art. 15.157.63 ≙ 30 X 8
Art. 15.157.64 ≙ 35 X 10
Art. 15.157.65 ≙ 40 X 8

H.350 mm c.a.

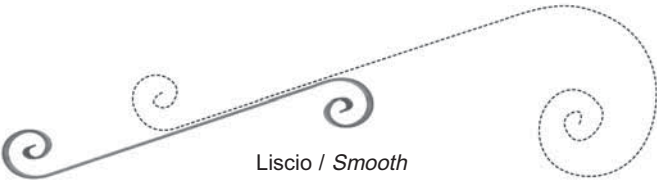

Liscio / Smooth
L.1150 mm.
Art. 15.157.66 ≙ 30 X 8
Art. 15.157.67 ≙ 35 X 10
Art. 15.157.68 ≙ 40 X 8

N.B.: Nel piatto liscio
sinistro o destro sono uguali.
Note: Right and left sides are equal in
smooth flat sections.

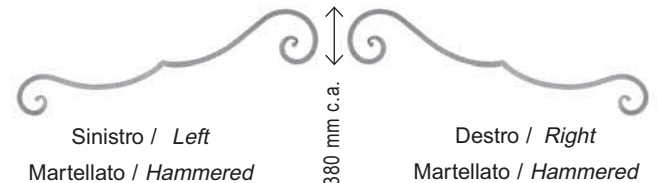

Sinistro / Left
Martellato / Hammered
L.2100 mm.
Art. 15.157.69 ≙ 35 X 8
Art. 15.157.71 ≙ 40 X 8

Destro / Right
Martellato / Hammered
L.2100 mm.
Art. 15.157.70 ≙ 35 X 8
Art. 15.157.72 ≙ 40 X 8

H.380 mm c.a.

H.850 mm c.a.

Liscio / Smooth
L.2100 mm.
Art. 15.157.73 ≙ 35 X 8
Art. 15.157.74 ≙ 40 X 8

N.B.: Nel piatto liscio
sinistro o destro sono uguali.
Note: Right and left sides are equal in
smooth flat sections.



Sinistro / Left
Martellato / Hammered
L.2000 mm.
Art. 15.157.75 ≙ 35 X 8
Art. 15.157.77 ≙ 40 X 8

Destro / Right
Martellato / Hammered
L.2000 mm.
Art. 15.157.76 ≙ 35 X 8
Art. 15.157.78 ≙ 40 X 8

H.760 mm c.a.

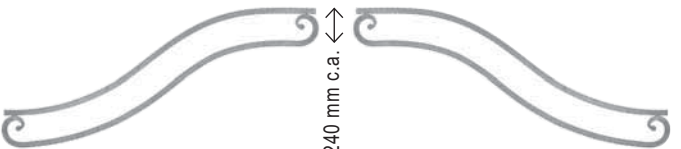

Sinistro / Left
Martellato / Hammered
L.2000 mm.
Art. 15.157.81 ≙ 35 X 8
Art. 15.157.83 ≙ 40 X 8

Destro / Right
Martellato / Hammered
L.2000 mm.
Art. 15.157.82 ≙ 35 X 8
Art. 15.157.84 ≙ 40 X 8

H.240 mm c.a.

H.800 mm c.a.

Liscio / Smooth
L.2000 mm.
Art. 15.157.79 ≙ 35 X 8
Art. 15.157.80 ≙ 40 X 8

N.B.: Nel piatto liscio
sinistro o destro sono uguali.
Note: Right and left sides are equal in
smooth flat sections.

Liscio / Smooth
L.2000 mm.
Art. 15.157.85 ≙ 35 X 8
Art. 15.157.86 ≙ 40 X 8

N.B.: Nel piatto liscio
sinistro o destro sono uguali.
Note: Right and left sides are equal in
smooth flat sections.



Sinistro / Left
Martellato / Hammered
L.1900 mm.
Art. 15.157.87 ≙ 35 X 8
Art. 15.157.89 ≙ 40 X 8

Destro / Right
Martellato / Hammered
L.1900 mm.
Art. 15.157.88 ≙ 35 X 8
Art. 15.157.90 ≙ 40 X 8

H.550 mm c.a.

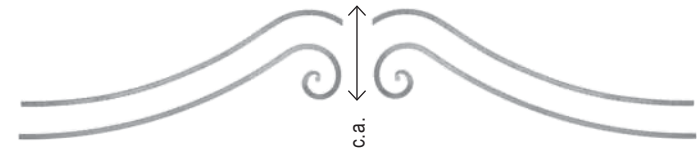

Sinistro / Left
Martellato / Hammered
L.2100 mm.
Art. 15.157.93 ≙ 35 X 8
Art. 15.157.95 ≙ 40 X 8

Destro / Right
Martellato / Hammered
L.2100 mm.
Art. 15.157.94 ≙ 35 X 8
Art. 15.157.96 ≙ 40 X 8

H.600 mm c.a.

H.900 mm c.a.

Liscio / Smooth
L.1900 mm.
Art. 15.157.91 ≙ 35 X 8
Art. 15.157.92 ≙ 40 X 8

N.B.: Nel piatto liscio
sinistro o destro sono uguali.
Note: Right and left sides are equal in
smooth flat sections.

Liscio / Smooth
L.2100 mm.
Art. 15.157.97 ≙ 35 X 8
Art. 15.157.98 ≙ 40 X 8

N.B.: Nel piatto liscio
sinistro o destro sono uguali.
Note: Right and left sides are equal in
smooth flat sections.

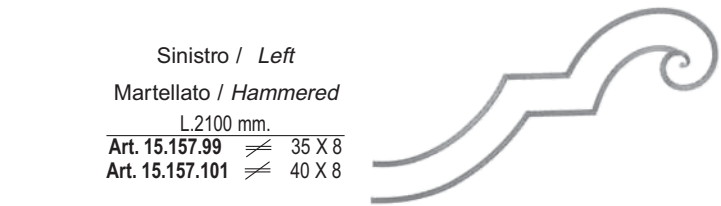

Sinistro / Left
Martellato / Hammered
L.2100 mm.
Art. 15.157.99 ≙ 35 X 8
Art. 15.157.101 ≙ 40 X 8

Liscio / Smooth
L.2100 mm.
Art. 15.157.103 ≙ 35 X 8
Art. 15.157.104 ≙ 40 X 8

H.550 mm c.a.

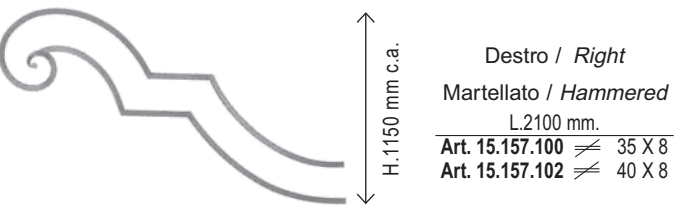

Destro / Right
Martellato / Hammered
L.2100 mm.
Art. 15.157.100 ≙ 35 X 8
Art. 15.157.102 ≙ 40 X 8

N.B.: Nel piatto liscio
sinistro o destro sono uguali.
Note: Right and left sides are equal in
smooth flat sections.

H.1150 mm c.a.

Pezzi forniti singolarmente / These pieces are furnished separately

CIMASE E CANCELLI PEDONALI



Liscio / Smooth

H.150 X L.1500 mm.

Art. 15.157.105 ≙ 30 X 8
Art. 15.157.106 ≙ 35 X 8
Art. 15.157.107 ≙ 40 X 8

Martellato / Hammered

H.150 X L.1500 mm.

Art. 15.157.108 ≙ 30 X 8
Art. 15.157.109 ≙ 35 X 8
Art. 15.157.110 ≙ 40 X 8



Tubolare Liscio
Smooth Bars

H.150 X L.1450 mm.

Art. 15.157.114 □ 30 X 30
Art. 15.157.115 □ 40 X 20

Tubolare Martellato
Hammered Bars

H.150 X L.1450 mm.

Art. 15.157.116 □ 30 X 30
Art. 15.157.117 □ 40 X 20



Liscio / Smooth

H.180 X L.1300 mm.

Art. 15.157.118 ≙ 30 X 8
Art. 15.157.119 ≙ 35 X 8
Art. 15.157.120 ≙ 40 X 8

Martellato / Hammered

H.180 X L.1300 mm.

Art. 15.157.121 ≙ 30 X 8
Art. 15.157.122 ≙ 35 X 8
Art. 15.157.123 ≙ 40 X 8



Liscio / Smooth

H.190 X L.1000 mm.

Art. 15.157.124 ≙ 30 X 8
Art. 15.157.125 ≙ 35 X 10
Art. 15.157.126 ≙ 40 X 8

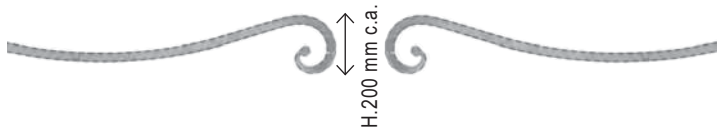

Sinistro / Left

Martellato / Hammered

H.200 X L.1000 mm.

Art. 15.157.127 ≙ 30 X 8
Art. 15.157.129 ≙ 35 X 8

Destro / Right

Martellato / Hammered

H.200 X L.1000 mm.

Art. 15.157.128 ≙ 30 X 8
Art. 15.157.130 ≙ 35 X 8

Liscio / Smooth

H.200 X L.1000 mm.

Art. 15.157.131 ≙ 30 X 8
Art. 15.157.132 ≙ 35 X 8

N.B.: Nel piatto liscio
sinistro o destro sono uguali.
Note: Right and left sides are equal in
smooth flat sections.

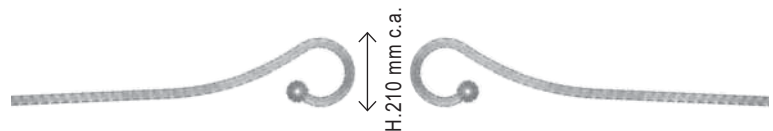

Sinistro / Left

Martellato / Hammered

H.210 X L.1000 mm.

Art. 15.157.133 ≙ 30 X 8
Art. 15.157.135 ≙ 35 X 8

Destro / Right

Martellato / Hammered

H.210 X L.1000 mm.

Art. 15.157.134 ≙ 30 X 8
Art. 15.157.136 ≙ 35 X 8



Sinistro / Left

Liscio / Smooth

H.210 X L.1000 mm.

Art. 15.157.137 ≙ 30 X 8
Art. 15.157.138 ≙ 35 X 8

Destro / Right

Liscio / Smooth

H.210 X L.1000 mm.

Art. 15.157.193 ≙ 30 X 8
Art. 15.157.194 ≙ 35 X 8

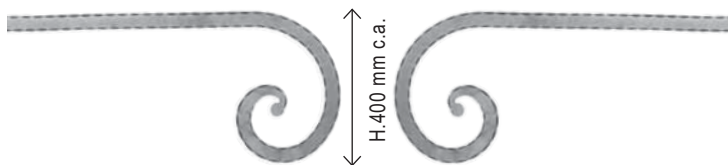

Sinistro / Left

Martellato / Hammered

H.400 X L.1000 mm.

Art. 15.157.139 ≙ 30 X 8
Art. 15.157.141 ≙ 35 X 8
Art. 15.157.143 ≙ 40 X 8

Destro / Right

Martellato / Hammered

H.400 X L.1000 mm.

Art. 15.157.140 ≙ 30 X 8
Art. 15.157.142 ≙ 35 X 8
Art. 15.157.144 ≙ 40 X 8

Liscio / Smooth

H.400 X L.1000 mm.

Art. 15.157.145 ≙ 30 X 8
Art. 15.157.146 ≙ 35 X 8
Art. 15.157.147 ≙ 40 X 8

N.B.: Nel piatto liscio
sinistro o destro sono uguali.
Note: Right and left sides are equal in
smooth flat sections.

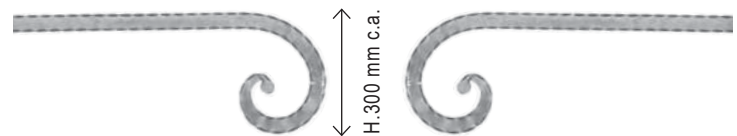

Sinistro / Left

Martellato / Hammered

H.300 X L.1000 mm.

Art. 15.157.148 ≙ 30 X 8
Art. 15.157.150 ≙ 35 X 8
Art. 15.157.152 ≙ 40 X 8

Destro / Right

Martellato / Hammered

H.300 X L.1000 mm.

Art. 15.157.149 ≙ 30 X 8
Art. 15.157.151 ≙ 35 X 8
Art. 15.157.153 ≙ 40 X 8

Liscio / Smooth

H.300 X L.1000 mm.

Art. 15.157.154 ≙ 30 X 8
Art. 15.157.155 ≙ 35 X 8
Art. 15.157.156 ≙ 40 X 8

N.B.: Nel piatto liscio
sinistro o destro sono uguali.
Note: Right and left sides are equal in
smooth flat sections.

Pezzi forniti singolarmente / *These pieces are furnished separately*

CIMASE E CANCELLI PEDONALI



Sinistro / *Left*

Destro / *Right*

Martellato / *Hammered*

Martellato / *Hammered*

H.200 X L.1000 mm.

H.200 X L.1000 mm.

Art. 15.157.157 ≙ 30 X 8

Art. 15.157.158 ≙ 30 X 8

Art. 15.157.159 ≙ 35 X 8

Art. 15.157.160 ≙ 35 X 8

Art. 15.157.161 ≙ 40 X 8

Art. 15.157.162 ≙ 40 X 8

Liscio / *Smooth*

N.B.: Nel piatto liscio
sinistro o destro sono uguali.

Note: *Right and left sides are equal in
smooth flat sections.*

H.200 X L.1000 mm.

Art. 15.157.163 ≙ 30 X 8

Art. 15.157.164 ≙ 35 X 8

Art. 15.157.165 ≙ 40 X 8



Sinistro / *Left*

Destro / *Right*

Martellato / *Hammered*

Martellato / *Hammered*

H.400 X L.1000 mm.

H.400 X L.1000 mm.

Art. 15.157.166 ≙ 30 X 8

Art. 15.157.167 ≙ 30 X 8

Art. 15.157.168 ≙ 35 X 8

Art. 15.157.169 ≙ 35 X 8

Art. 15.157.170 ≙ 40 X 8

Art. 15.157.171 ≙ 40 X 8

Liscio / *Smooth*

N.B.: Nel piatto liscio
sinistro o destro sono uguali.

Note: *Right and left sides are equal in
smooth flat sections.*

H.400 X L.1000 mm.

Art. 15.157.172 ≙ 30 X 8

Art. 15.157.173 ≙ 35 X 8

Art. 15.157.174 ≙ 40 X 8



Sinistro / *Left*

Destro / *Right*

Martellato / *Hammered*

Martellato / *Hammered*

H.300 X L.800 mm.

H.300 X L.800 mm.

Art. 15.157.175 ≙ 30 X 8

Art. 15.157.176 ≙ 30 X 8

Art. 15.157.177 ≙ 35 X 8

Art. 15.157.178 ≙ 35 X 8

Art. 15.157.179 ≙ 40 X 8

Art. 15.157.180 ≙ 40 X 8

Liscio / *Smooth*

N.B.: Nel piatto liscio
sinistro o destro sono uguali.

Note: *Right and left sides are equal in
smooth flat sections.*

H.300 X L.800 mm.

Art. 15.157.181 ≙ 30 X 8

Art. 15.157.182 ≙ 35 X 8

Art. 15.157.183 ≙ 40 X 8



Sinistro / *Left*

Destro / *Right*

Martellato / *Hammered*

Martellato / *Hammered*

H.200 X L.500 mm.

H.200 X L.500 mm.

Art. 15.157.184 ≙ 30 X 8

Art. 15.157.185 ≙ 30 X 8

Art. 15.157.186 ≙ 35 X 8

Art. 15.157.187 ≙ 35 X 8

Art. 15.157.188 ≙ 40 X 8

Art. 15.157.189 ≙ 40 X 8

Liscio / *Smooth*

N.B.: Nel piatto liscio
sinistro o destro sono uguali.

Note: *Right and left sides are equal in
smooth flat sections.*

H.200 X L.500 mm.

Art. 15.157.190 ≙ 30 X 8

Art. 15.157.191 ≙ 35 X 8

Art. 15.157.192 ≙ 40 X 8





Sinistro / Left
Martellato / Hammered
H. 370 x L. 1500 mm.
Art.15.157.200 \neq 30 x 8 mm

Liscio / Smooth
H. 370 x L. 1500 mm.
Art.15.157.206 \neq 30 x 8 mm



Destro / Right
Martellato / Hammered
H. 370 x L. 1500 mm.
Art.15.157.201 \neq 30 x 8 mm

N.B.: Il piatto liscio sinistro o destro sono uguali.
Note: Right and left sides are equal in smooth flat sections.

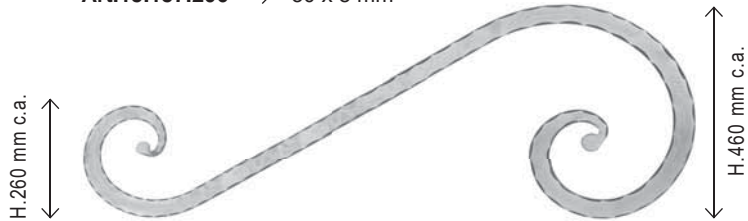

Sinistro / Left
Martellato / Hammered
H. 460 x L. 1500 mm.
Art.15.157.209 \neq 30 x 8 mm

Liscio / Smooth
H. 460 x L. 1500 mm.
Art.15.157.215 \neq 30 x 8 mm



Destro / Right
Martellato / Hammered
H. 460 x L. 1500 mm.
Art.15.157.210 \neq 30 x 8 mm

N.B.: Il piatto liscio sinistro o destro sono uguali.
Note: Right and left sides are equal in smooth flat sections.



Sinistro / Left
Martellato / Hammered
H. 240 x L. 1500 mm.
Art.15.157.218 \neq 30 x 8 mm

Liscio / Smooth
H. 240 x L. 1500 mm.
Art.15.157.221 \neq 30 x 8 mm



Destro / Right
Martellato / Hammered
H. 240 x L. 1500 mm.
Art.15.157.219 \neq 30 x 8 mm

N.B.: Il piatto liscio sinistro o destro sono uguali.
Note: Right and left sides are equal in smooth flat sections.



Sinistro / Left
Martellato / Hammered
H. 360 x L. 1500 mm.
Art.15.157.224 \neq 30 x 8 mm

Liscio / Smooth
H. 360 x L. 1500 mm.
Art.15.157.227 \neq 30 x 8 mm



Destro / Right
Martellato / Hammered
H. 360 x L. 1500 mm.
Art.15.157.225 \neq 30 x 8 mm

N.B.: Il piatto liscio sinistro o destro sono uguali.
Note: Right and left sides are equal in smooth flat sections.



Sinistro / Left
Martellato / Hammered
H. 400 x L. 2100 mm.
Art.15.157.280 \neq 30 x 8 mm

Liscio / Smooth
H. 400 x L. 2100 mm.
Art.15.157.286 \neq 30 x 8 mm

Destro / Right
Martellato / Hammered
H. 400 x L. 2100 mm.
Art.15.157.281 \neq 30 x 8 mm

N.B.: Il piatto liscio sinistro o destro sono uguali.
Note: Right and left sides are equal in smooth flat sections.



≅ 70 X L.6 mm.
Art. 15.158 H. 300 mm.
Art. 15.159 H.2000 mm.
Art. 15.160 H.3000 mm.



Zincato/Galvanized Zincato/Galvanized
Art. 15.161 Art. 15.162
A = 40 mm. A = 45 mm.
B = 60 mm. B = 45 mm.
C = 20 mm. C = 24 mm.



H. 160 X L.30 mm.
Art. 15.163



H. 130 X L.29 mm.
Art. 15.163.01



H. 100 X L.20 mm.
Art. 15.163.02



Perno / Pin
Ø 16mm

Forgiato a mano / Hand Forged
H. 328 x L. 110 mm
Art. 15.210 ≅ 8

Cardini e cerniere forgiati a mano per portali / Hand forged hinges for front doors



Forgiato a mano / Hand Forged
L. 780 mm
Art. 15.200 ≅ 40 x 8
fori / holes Ø 16,5 mm



Forgiato a mano / Hand Forged
L. 740 mm
Art. 15.201 ≅ 40 x 8
fori / holes Ø 16,5 mm

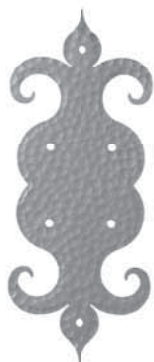

NEW

H. 400 x L. 145 mm
Art. 15.220
sp./ thckn. 4 mm



Forgiato / Forged
H. 525 x L. 105 mm
Art. 15.250 □ 30 mm



Forgiato / Forged
H. 610 x L. 180 mm
Art. 15.251 □ 30 mm
Art. 15.251.01 □ 25 mm



Forgiato / Forged
H. 920 x L. 220 mm
Art. 15.252 □ 30 mm
Art. 15.252.01 □ 25 mm



Forgiato / Forged
H. 650 x L. 285 mm
Art. 15.253 □ 30 mm

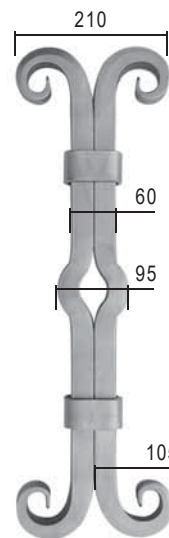

NEW

Forgiato / Forged
H. 660 x L. 210 mm
Art. 15.254 □ 30 mm

NEW Art. 15.251.02 ≅ 50x20 mm

Tutte le parti di questo catalogo - foto comprese - sono di proprietà Euro-Fer. La riproduzione, anche parziale, è vietata in ogni forma e con ogni mezzo. / Every part of this catalogue - photos included - is Euro-Fer's property. All forms of copying are strictly prohibited.

COMPONENTI VARI PER ARREDAMENTO
VARIOUS DECOR ELEMENTS



L.120 mm.
Art. 16.001



H.230 X L.60 mm.
Art. 16.002



H.270 X L.60 mm.
Art. 16.003



Art. 16.003.01



Art. 16.003.02



H.410 X L.100 mm.
Art. 16.003.03 Ø 25 mm circa



H.400 X L.90 mm
Art. 16.003.04



H.350 X L.75 mm
Art. 16.003.05

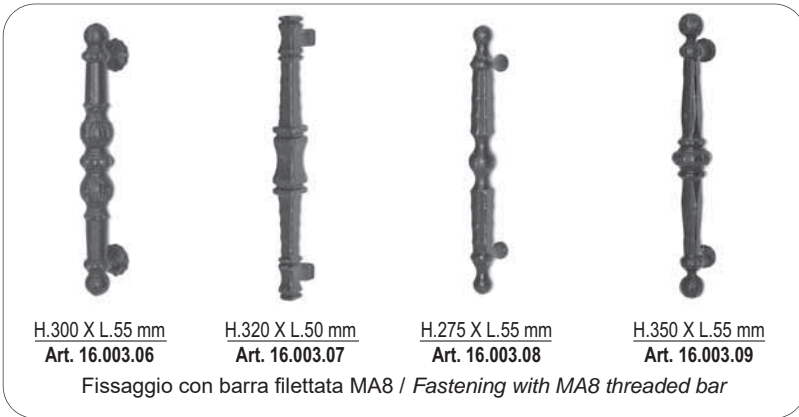

H.300 X L.55 mm
Art. 16.003.06

H.320 X L.50 mm
Art. 16.003.07

H.275 X L.55 mm
Art. 16.003.08

H.350 X L.55 mm
Art. 16.003.09



H.310 X L.50 mm
Art. 16.003.10
Forgiato / Forged



H.410 X L.70 mm
Art. 16.003.11
Forgiato / Forged

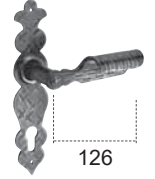

H.233 X L.50 mm.
Art. 16.004 (a coppia)

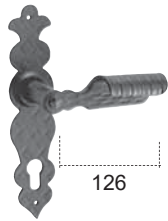

H.233 X L.50 mm.
Art. 16.005 (a coppia)



H.268 X L.49 mm.
Art. 16.006 (a coppia)



Art. 16.007

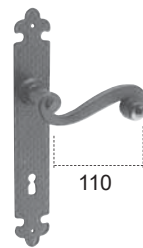

H.252 X L.38 mm.
Art. 16.008 (a coppia)



H.268 X L.49 mm.
Art. 16.009 (a coppia)



L.142 mm.
Art. 16.010 (a coppia)



L.142 mm.
Art. 16.011 (a coppia)



L.160 mm.
Art. 16.011.01 (a coppia)

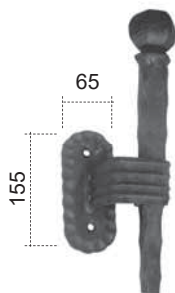

H.340 X L.100 mm.
Art. 16.011.02 (a coppia)



H.268 X L.49 mm.
Art. 16.012



H.250 X L.56 mm.
Art. 16.013 (a coppia)



H.250 X L.56 mm.
Art. 16.014

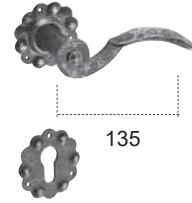

L.135 mm.
Art. 16.015 (a coppia)

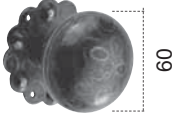

H.60 mm.
Art. 16.016

Borchia a 1 punta



Ø 12 mm.
Art. 16.018
Ø 15 mm.
Art. 16.018.01
Ø 20 mm.
Art. 16.018.02

Borchia a 2 punte

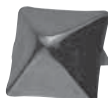

15 X 15 mm.
Art. 16.019
20 X 20 mm.
Art. 16.019.01



Art. 16.020

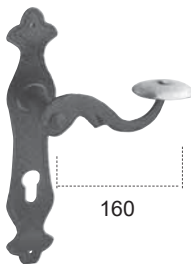

H.230 X L.50 mm.
Art. 16.021 (a coppia)



L.110 mm.
Art. 16.022



H.170 mm.
Art. 16.022.01



H.90 mm.
Art. 16.022.02

Sporgenza d'ingombro 110 mm.
Wall protusion = 110 mm.

Tutte le parti di questo catalogo - foto comprese - sono di proprietà Euro-Fer. La riproduzione, anche parziale, è vietata in ogni forma e con ogni mezzo. / Every part of this catalogue - photos included - is Euro-Fer's property. All forms of copying are strictly prohibited.



H.165 mm.
Art. 16.022.03
Sporgenza d'ingombro 55 mm.
Wall protusion = 55 mm.



H.200 mm.
Art. 16.022.04
Sporgenza d'ingombro 80 mm.
Wall protusion = 80 mm.



H.80 mm.
Art. 16.022.05
Sporgenza d'ingombro 40 mm.
Wall protusion = 40 mm.

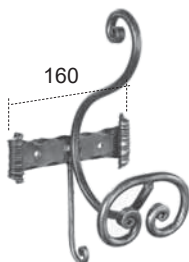

H.305 X L.160 mm.
Art. 16.022.06
Sporgenza d'ingombro 150 mm.
Wall protusion = 150 mm.

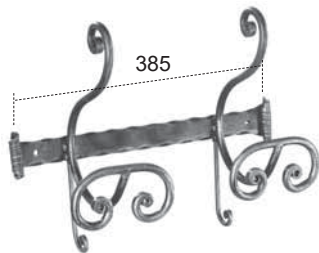

H.305 X L.385 mm.
Art. 16.022.07
Sporgenza d'ingombro 150 mm.
Wall protusion = 150 mm.

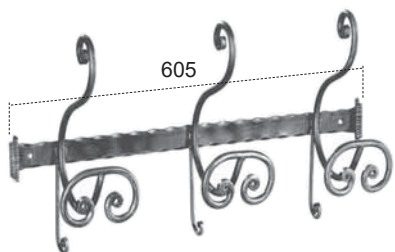

H.305 X L.605 mm.
Art. 16.022.08
Sporgenza d'ingombro 150 mm.
Wall protusion = 150 mm.

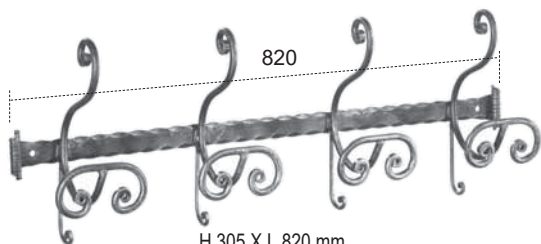

H.305 X L.820 mm.
Art. 16.022.09
Sporgenza d'ingombro 150 mm.
Wall protusion = 150 mm.



H 1860 mm.
Art. 16.022.10
Ingombro al pavimento Ø 600 mm.
Ingombro superiore Ø 500 mm.
Lower dimensions = 600 mm. Ø
Upper dimensions = 500 mm. Ø



H 1830 mm.
Art. 16.022.11
Ingombro al pavimento Ø 600 mm.
Ingombro superiore Ø 500 mm.
Lower dimensions = 600 mm. Ø
Upper dimensions = 500 mm. Ø

Girevole / Revolving





N.	Spessore 4 mm.
0	Art. 16.022.12
1	Art. 16.022.13
2	Art. 16.022.14
3	Art. 16.022.15
4	Art. 16.022.16
5	Art. 16.022.17
6	Art. 16.022.18
7	Art. 16.022.19
8	Art. 16.022.20
9	Art. 16.022.21

Bloccaggio con 2 viti e tasselli da 10
Locking with no. 2 size 10 screws
and expansion bolts

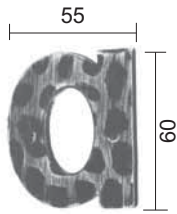

Spessore 4 mm.	
A	Art. 16.022.22
B	Art. 16.022.23
C	Art. 16.022.24
D	Art. 16.022.25

Bloccaggio con 2 viti e tasselli da 10
Locking with no. 2 size 10 screws
and expansion bolts

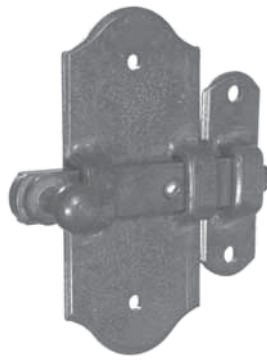

H.100 X L.85 mm.
Profondità 40 mm.

Art. 16.022.26
Spessore piastra d'appoggio 3 mm.
Support plate thickness = 3 mm.



H.45 X L.250 mm.
Profondità 40 mm.

Art. 16.022.27
Spessore piastra d'appoggio 2 mm.
Support plate thickness = 2 mm.



Art. 16.022.29

Ottone / Brass



H.65 X L.100 mm.

Art. 16.022.30

Fissaggio con tasselli da 10 mm.
Fastening with size 10 expansion bolts



H.125 X L.130 mm.

Art. 16.022.31

Fissaggio con tasselli da 10 mm.
Fastening with size 10 expansion bolts



H.70 X L.120 mm.

Art. 16.022.32

Fissaggio con tasselli da 10 mm.
Fastening with size 10 expansion bolts



Ottone / Brass

Ø 120 Profondità 40 mm.

Art. 16.022.33

Fissaggio con barra filettata MA 6
Fastening with MA 6 threaded bar



Ø 140 Profondità 40 mm.

Art. 16.022.34

Fissaggio con barra filettata MA 6
Fastening with MA 6 threaded bar

Elementi in ottone / Knockers and Handles



H 140 Profondità 40 mm.

Art. 16.022.35

Fissaggio con barra filettata MA 6
Fastening with MA 6 threaded bar



Art. 16.022.36

Elementi in ottone / Knockers and Handles



H 200 Profondità 60 mm.

Art. 16.022.39

Fissaggio con barra filettata MA 6
Fastening with MA 6 threaded bar



H 200 Profondità 60 mm.

Art. 16.022.41

Fissaggio con barra filettata MA 6
Fastening with MA 6 threaded bar

H 250 Profondità 60 mm.

Art. 16.022.40

Fissaggio con barra filettata MA 6
Fastening with MA 6 threaded bar

H 250 Profondità 60 mm.

Art. 16.022.42

Fissaggio con barra filettata MA 6
Fastening with MA 6 threaded bar



H. 140 x L.140 mm

Art. 16.022.43

H. 100 x L.100 mm

Art. 16.022.44

H. 55 x L.55 mm

Art. 16.022.45

Fissaggio con barra filettata MA6 / Fastening with MA6 threaded bar



Venduti in coppia
Sold in pairs



H.330 X L.420 mm.
Art. 16.023

Venduti in coppia
Sold in pairs

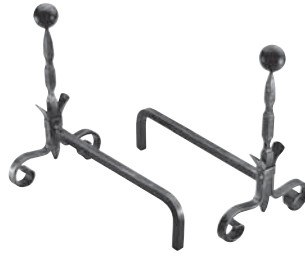

H.400 X L.420 mm.
Art. 16.025

Venduti in coppia
Sold in pairs



H.460 X L.420 mm.
Art. 16.027



H.630 mm.
Art. 16.024

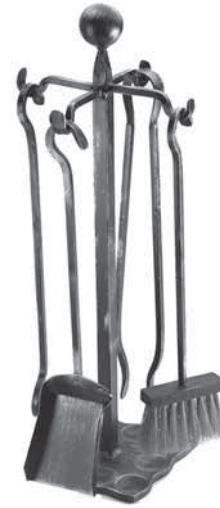

H.600 mm.
Art. 16.026

Venduti in coppia
Sold in pairs



H.460 X L.610 mm.
Art. 16.028.01

Venduti in coppia
Sold in pairs



H.465 X L.530 mm.
Art. 16.028.03



H.870 X L.375 mm.
Art. 16.028.02



H.750 X L.360 mm.
Art. 16.028.05

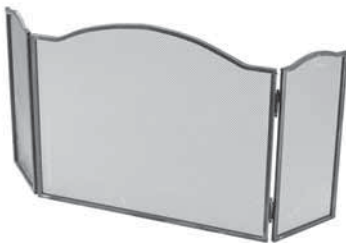

H.500 X L.1000 mm.
Art. 16.029

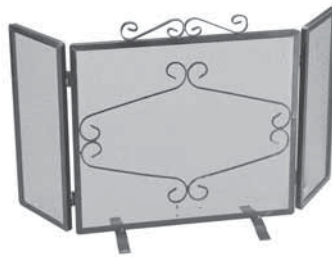

H.500 X L.900 mm.
Art. 16.030

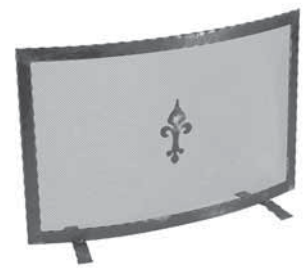

H.480 X L.700 mm.
Art. 16.032



H.510 X L.1000 mm.
Art. 16.032.02
Profondità appoggio 180 mm.
Support depth = 180 mm.



Fuori Produzione
Out of Production

Art. 16.032.03

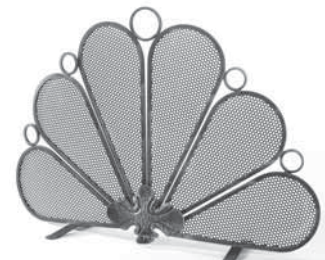

H.520 X L.745 mm.
Art. 16.032.04
Profondità appoggio 180 mm.
Support depth = 180 mm.



H.180 X L.400 mm.
Art. 16.033
Profondità appoggio 300 mm.
Support depth = 300 mm.



H.410 X L.260 mm.
Sporgenza d'ingombro 90 mm.
Wall protrusion = 90 mm

- Art. 16.034** Rosso / Red
Art. 16.036 Metallizzato / Metallized
Art. 16.037 Verde / Green
Art. 16.038 Grigio ghisa / Cast iron grey
Art. 16.039 Nero / Black



H.465 X L.298 mm.
Sporgenza d'ingombro 96 mm.
Wall protrusion = 96 mm

- Art. 16.040** Rosso / Red
Art. 16.041 Bordeaux / Red-Wine
Art. 16.042 Metallizzato / Metallized



H.360 X L.275 mm.
Art. 16.045.01
Sporgenza d'ingombro 115 mm.
Wall protrusion = 115 mm



H.410 X L. 250 mm.
Art. 16.045.03 rosso / red
Art. 16.045.04 verde / red
Sporgenza d'ingombro 100 mm.
Wall protrusion 100 mm.



- Art. 16.046** Patina Oro / Gold Patina 0,2 lt.
Art. 16.047 Patina Rame / Copper Patina 0,2 lt.
Art. 16.049 Patina Argento / Silver Patina 0,2 lt.

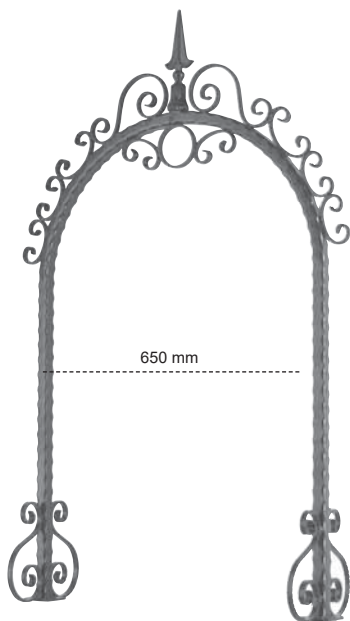

Martellato / *Hammered*
Art. 16.120

H 1340 X L.810 mm
Tubo □ 30 mm

Ricci Modello Scala / *Scala Model Scrolls*
≠ 14 X 6 mm



H. 280 x L.285 mm

Colore / *Colour*

Art. 16.151 Grigio / *Grey*



base 90 X H.135 mm.

Art. 16.150

Portacandele
Candle holder



H. 330 x L.465 mm

Colore / *Colour*

Art. 16.152 Grigio / *Grey*



H. 730 x L.680 mm

Colore / *Colour*

Art. 16.160 Grigio / *Grey*

Art. 16.160.01 Rame / *Copper*



H. 1100 x L.500 mm

Colore / *Colour*

Art. 16.161 Grigio / *Grey*

Art. 16.162 Rame / *Copper*

Finali per tubo tenda / Ends for curtain tube



H.150 X L.50 mm - Base Ø 20 mm
Art. 16.105 nero / black



H.240 X L.55 mm - Base Ø 20 mm
Art. 16.106 nero / black



H.205 X L.35 mm - Base Ø 20 mm
Art. 16.107 nero / black

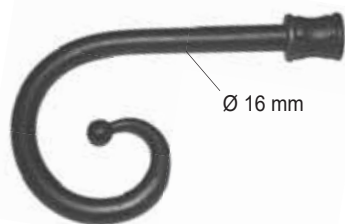

H.215 X L.125 mm - Base Ø 20 mm
Art. 16.108 nero / black

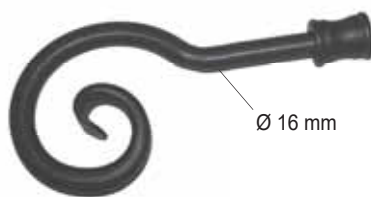

H.235 X L.110 mm - Base Ø 20 mm
Art. 16.109 nero / black

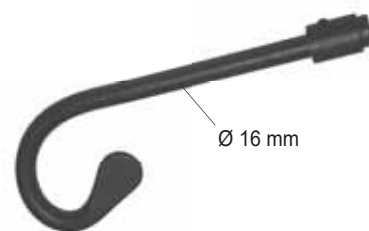

Ferma tenda / Curtain holder

H.210 X 80 mm
Art. 16.110 nero / black

Tubo per tenda / Curtain tube



L.2000 - Ø 20 mm
Art. 16.115 nero / black

L.3000 - Ø 20 mm
Art. 16.116 nero / black

Anelli tenda / Curtain rings

Gancetto non fornito / Hook not supplied

pz. 20
Diam. 40 mm
Art. 16.111 nero / black

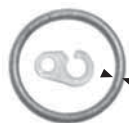

Ø esterno / out 40 mm
Ø interno / in 32 mm

Ø 4 mm

Fissaggio per supporto tubo / Wall fixing for tube support



Ø esterno / out 67 mm
Ø interno / in 17 mm

Art. 16.113C nero / black



Art. 16.113F

Supporto a parete per tubo / Wall support for tube



Per tubo / For tube - Ø 20 mm
Art. 16.112 nero / black

Supporto a sbalzo per tubo / Cantilever support for tube



L. 175 X 35 mm.
Per tubo / For tube - Ø 20 mm
Art. 16.113 nero / black

Installazione con supporto a sbalzo + finali per tubo / Installation with cantilever support + ends for curtain tube

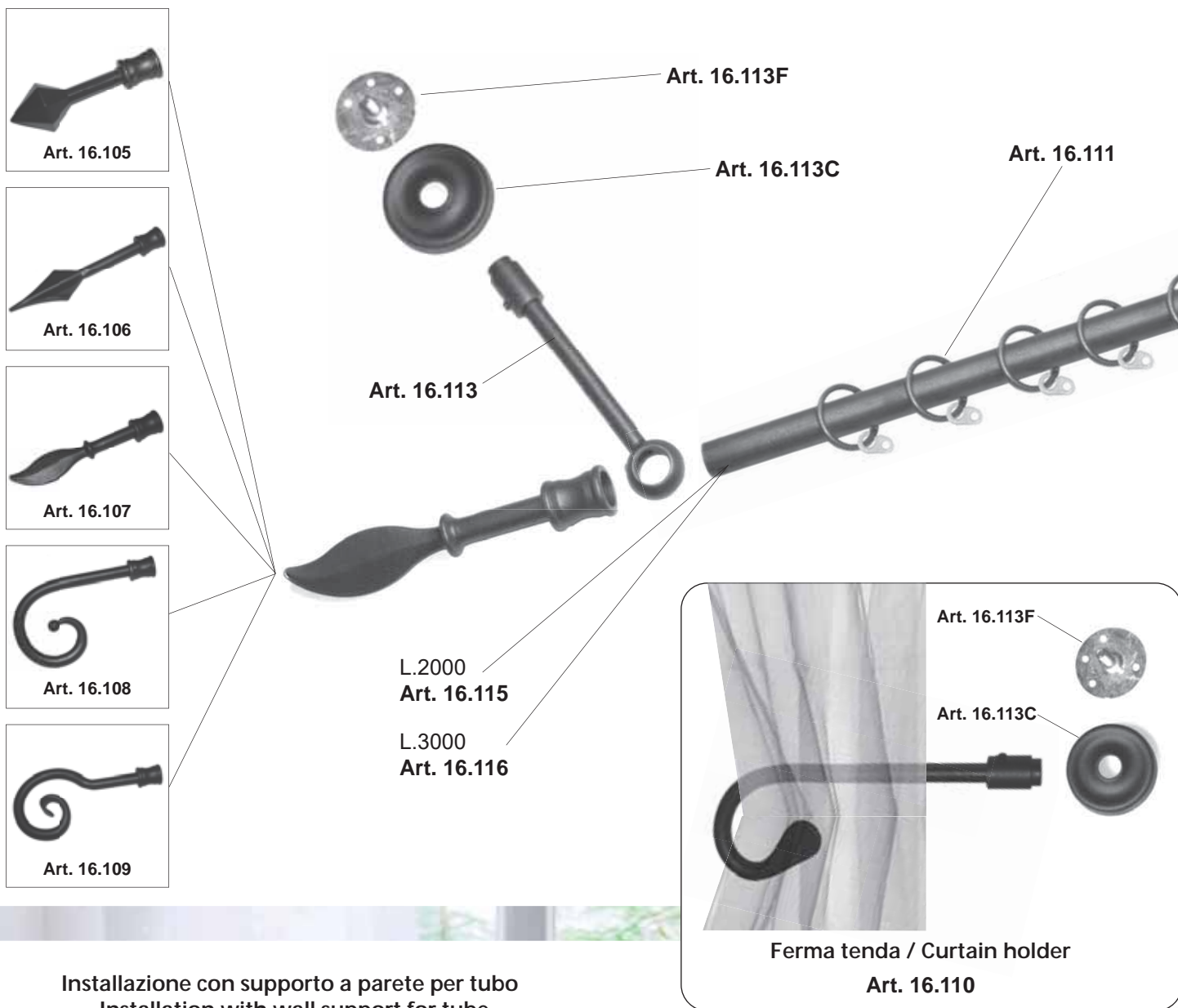

Installazione con supporto a parete per tubo
Installation with wall support for tube

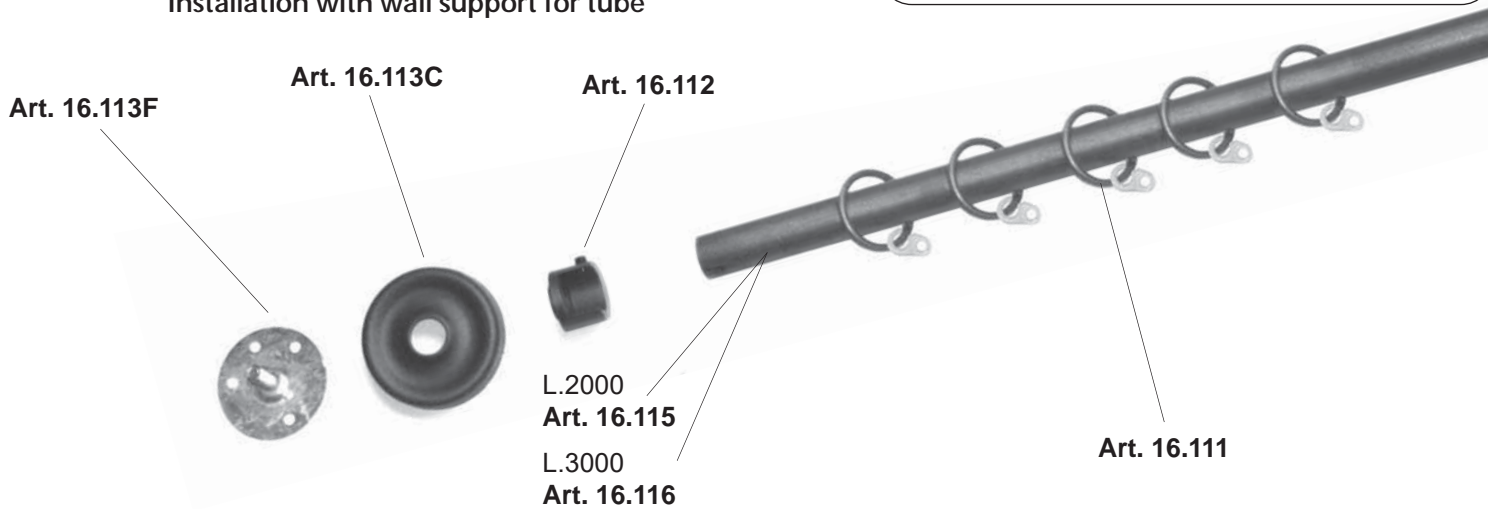



Nero / Black
Art. 16.200 H.1000 X L.900 mm.



Nero / Black
Art. 16.201 H.1000 X L.900 mm.



Nero / Black
Art. 16.203 H.1000 X L.900 mm.



Nero / Black
Art. 16.204 H.1000 X L.900 mm.

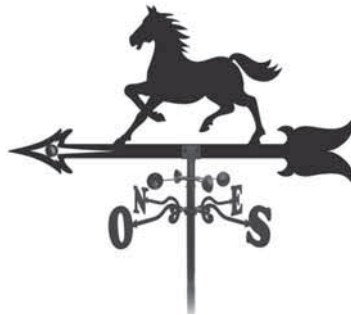

Nero / Black
Art. 16.205 H.1000 X L.900 mm.

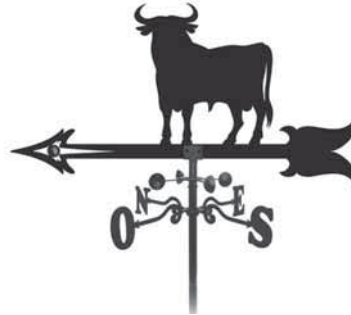

Nero / Black
Art. 16.206 H.1000 X L.900 mm.



Nero / Black
Art. 16.207 H.1000 X L.900 mm.



Nero / Black
Art. 16.208 H.1000 X L.900 mm.

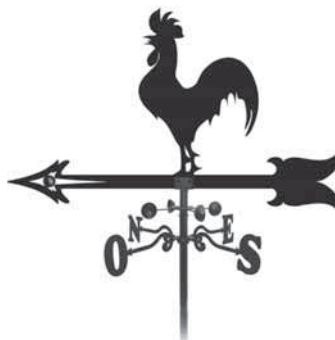

Nero / Black
Art. 16.209 H.1000 X L.900 mm.



Nero / Black
Art. 16.210 H.1000 X L.900 mm.



Nero / Black
Art. 16.212 H.1000 X L.900 mm.



Nero / Black
Art. 16.280
 Base di supporto per segnavento
Fixing support



Nero / Black
Art. 16.284
 Base di supporto a parete per segnavento
Walls support



Art. 16.285
 Bussola per regolazione segnavento
Compass

1. Avvitare i punti cardinali con un cacciavite. Fare attenzione che le lettere siano nella giusta posizione.
 2. Collocare l'anemometro sull'asta.
 3. Introdurre la parte superiore del segna vento sull'asta ed avvitarla fino in fondo con un cacciavite.
-
1. Screw the cardinal points through a screwdriver. Check that the letters are in the right position.
 2. Place the anemometer on the rod.
 3. Insert the upper part of the weather vanes in the rod and screw it in through a screwdriver.

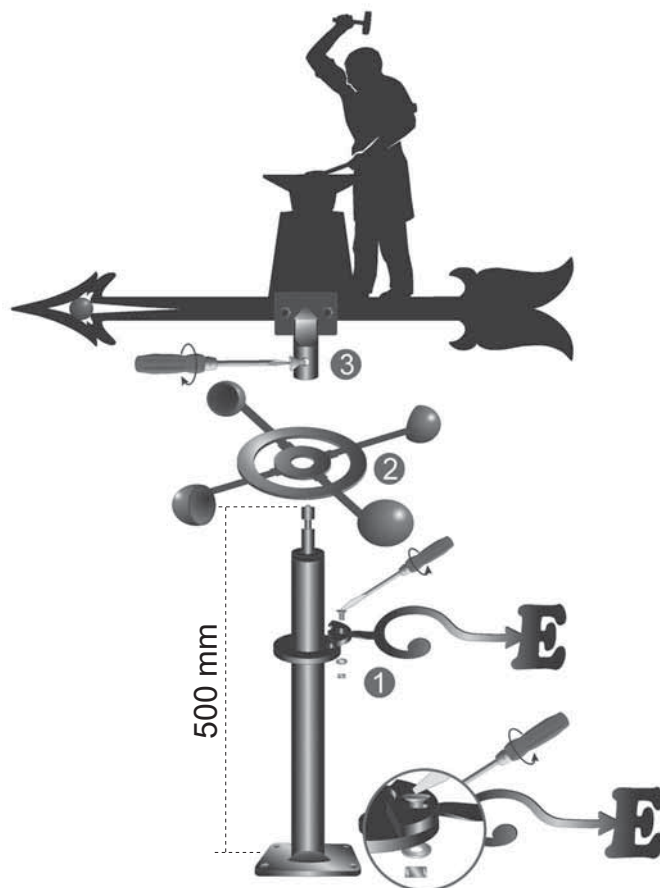

Istruzioni:

1. Nel collocare il supporto di fissaggio regolabile o quello da parete, bisogna tener presente che la parte piana dove si fisserà il palo del segnavento deve essere perfettamente a livello.
2. Una volta fissato il supporto, avvitare il palo completamente montato tramite le 4 viti, senza però fissarle del tutto. Orientare quindi il segnavento servendosi della bussola (in tutte le bussole la freccia segna il nord magnetico). Con il braccio della lettera "N" rivolto verso nord, fissare con forza le viti.

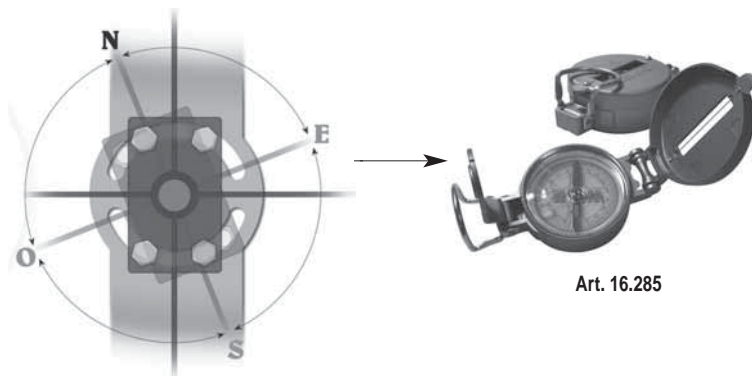

Art. 16.285

Instructions:

1. Either if you are placing the adjustable fixing support, or the walls one, you will need to consider that the flat surface where you place the pole of the weather vanes needs to be completely level.
2. Once the support has been fixed, screw the mounted pole using the 4 screws, but leave them slightly unscrewed then, orient the weather vanes through the compass (all compasses have the arrow pointing at the magnetic north) and with the compass arm of letter "N" pointing at the north, finally screw the screws completely to the end.

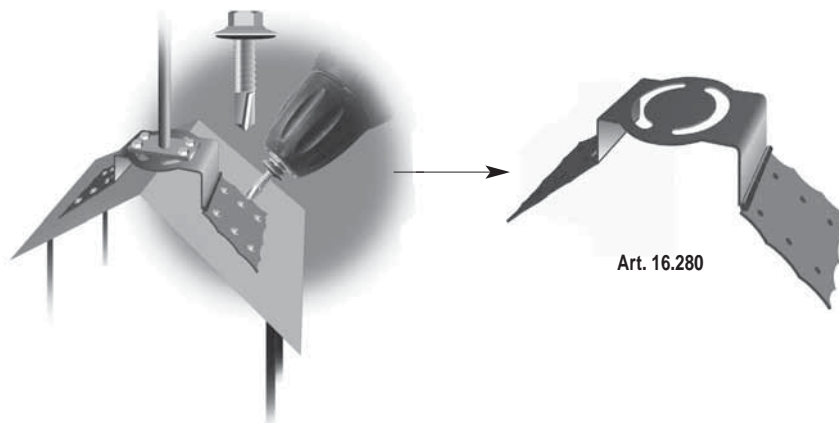

Art. 16.280

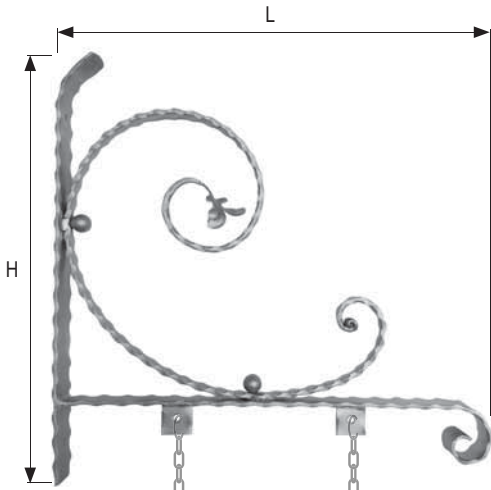

H. 550 x L. 570 mm
Art. 16.300
≠ 40x6
riccio / scroll ≠ 16x8

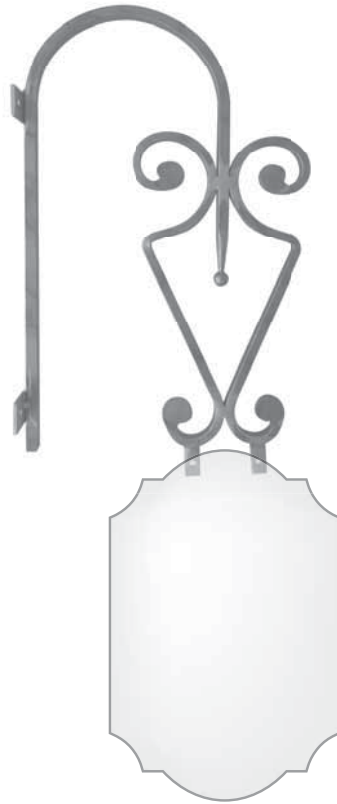

H. 500 x L. 300 mm
Art. 16.301
paletto / stake □ 12
riccio / scroll □ 10



H. 650 x L. 870 mm
Art. 16.302
≠ 35x10 liscio / smooth
riccio / scroll ≠ 16x6
modello scala / scala model

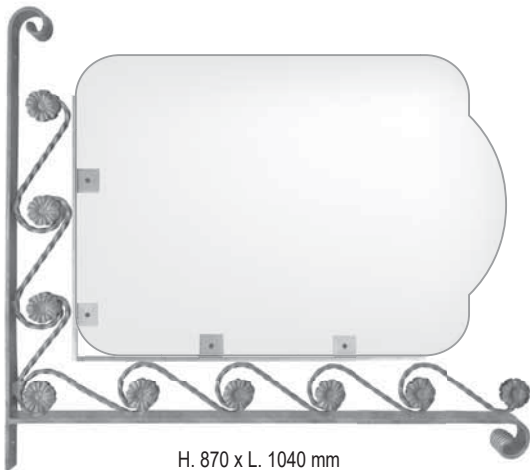

H. 870 x L. 1040 mm
Art. 16.303
≠ 35x10 liscio / smooth
riccio / scroll □ 10 attorcigliato / twisted
🌸 fiori su entrambi i lati / flowers on booth sides

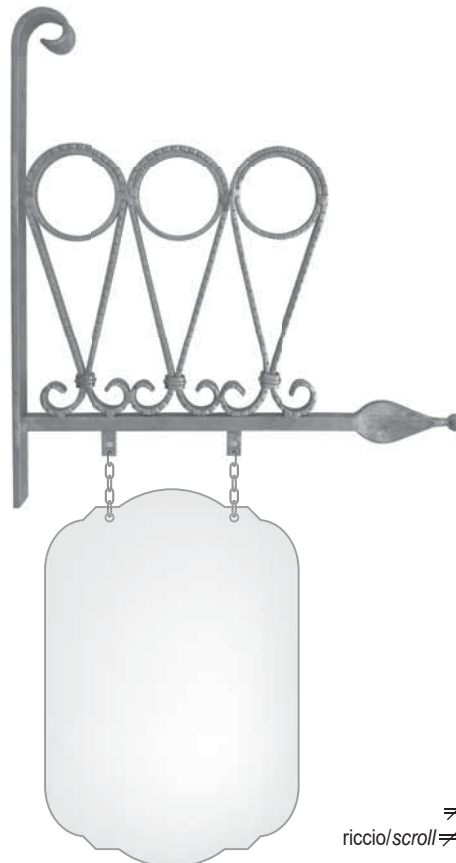

H. 660 x L. 510 mm
Art. 16.304
≠ 35x10 liscio / smooth
riccio / scroll ≠ 16x8
liscio / smooth

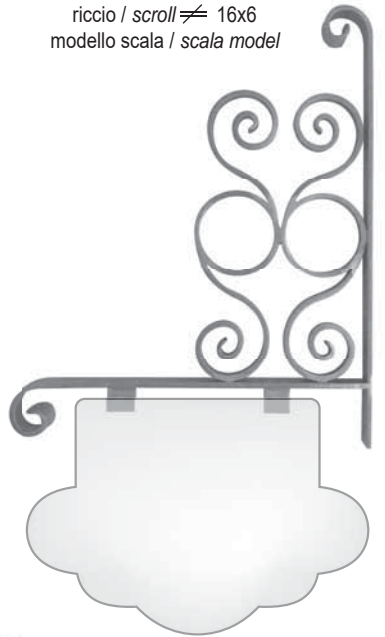

H. 550 x L. 510 mm
Art. 16.305
≠ 35x10 liscio/smooth
riccio/scroll ≠ 14x6 modello scala / scala model
paletto / stake □ 16



Le insegne sono realizzate con taglio laser, personalizzate con logo o nome dell'attività.

The signs are made with laser cutting, customized with logo or business name.

H. 500 x L. 570 mm
Art. 16.306
 ≠ 35x10 liscio / smooth
 riccio/scroll ≠ 12x6 liscio / smooth

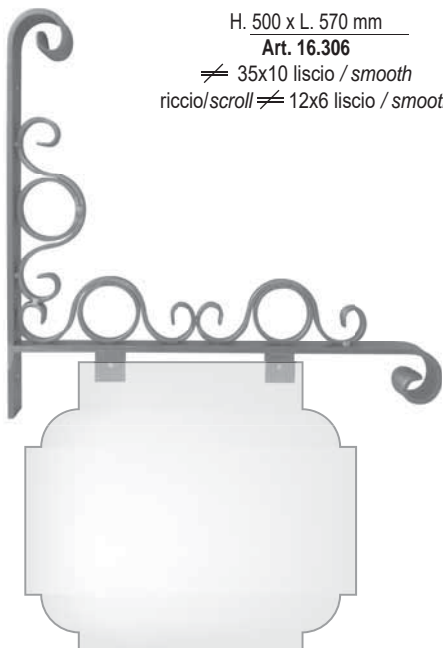

H. 680 x L. 570 mm
Art. 16.308
 ≠ 35x10 liscio / smooth
 rosone / rosette □ 12



H. 710 x L. 640 mm
Art. 16.307
 ≠ 35x10 liscio / smooth
 riccio / scroll Ø 12



H. 560 x L. 560 mm
Art. 16.309
 ≠ 35x10 liscio / smooth
 rosone / rosette ≠ 12x6



H. 460 x L. 770 mm
Art. 16.310
 ≠ 35x10 liscio / smooth
 rosone / rosette Ø 10



H. 560 x L. 580 mm
Art. 16.311
 ≠ 35x10 liscio / smooth
 riccio / scroll □ 10

Le insegne sono realizzate con taglio laser, personalizzate con logo o nome dell'attività.

The signs are made with laser cutting, customized with logo or business name.

**COMPONENTI IN GHISA
ELEMENTS IN CAST IRON**



Ferro fuso / Cast steel
H.65 x L.40 mm

Art. CS.13.142 □ 12,5



Ferro fuso / Cast steel
H.67 x L.45 mm

Art. CS.13.151 □ 12,5

Art. CS.13.152 □ 14,5

Art. CS.13.153 □ 16,5



Ferro fuso / Cast steel
H.38 x L.40 mm

Art. CS.13.900 □ 14,5

Art. CS.13.900.01 □ 16,5

Art. CS.13.900.02 □ 12,5



Ferro fuso / Cast steel
H.65 x L.40 mm

Art. CS.13.901 □ 14,5

Art. CS.13.901.01 □ 16,5

Art. CS.13.901.02 □ 12,5



Ghisa / Cast iron
H.45 x L.40 mm

Art. CI.13.902 □ 12,5

Art. CI.13.903 □ 14,5

**ARTICOLI ZINCATI A FREDDO
COLD GALVANIZED ARTICLES**

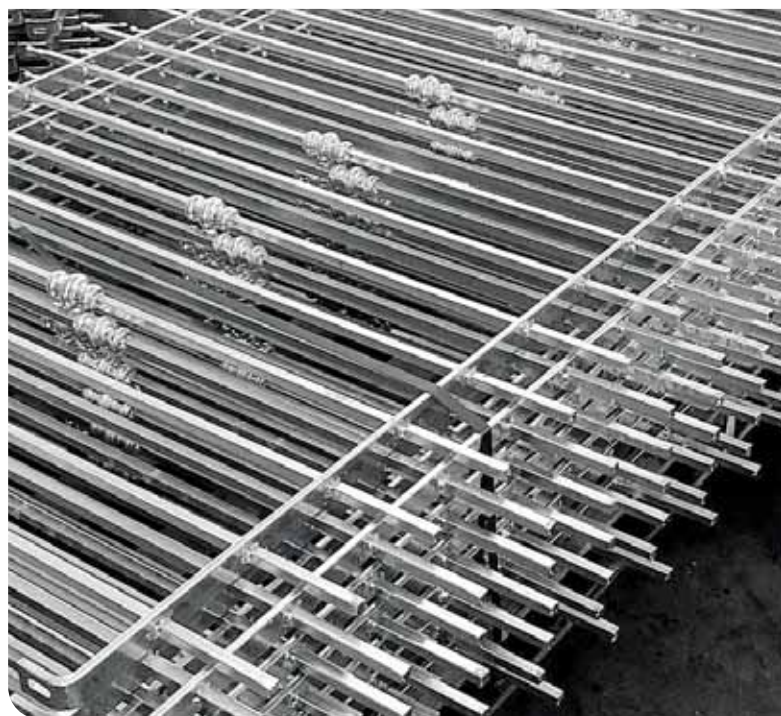
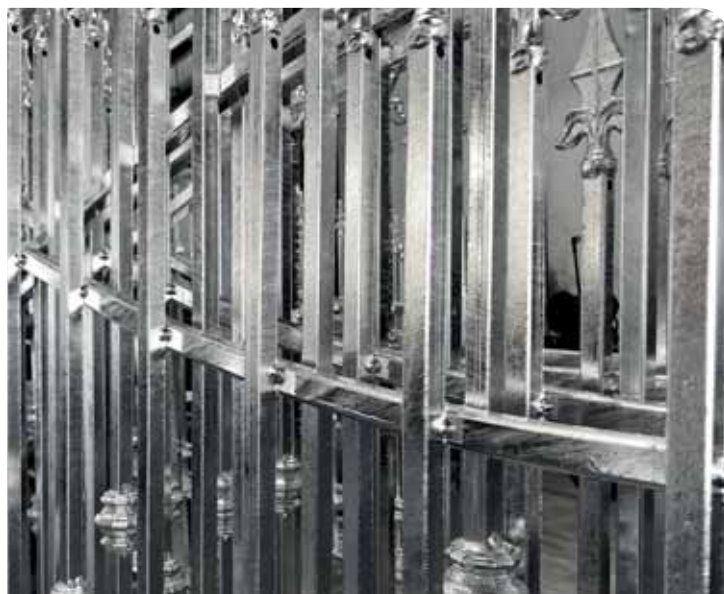



Liscio / Smooth
H.115 X L.75 mm
Art. 01.094.01.ZF ≠ 14 x 6 mm



Tondo / Round
H.350 X L.150 mm.
Art. 01.369.ZF Ø 14
Art. 01.370.ZF Ø 16

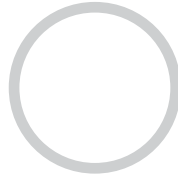

Liscio / Smooth
H.100 mm
Art. 02.031.ZF ≠ 12 x 6 mm



Liscio / Smooth
H.1500 mm
Art. 04.106.15.ZF Ø 14 mm
H.1500 mm
Art. 04.106.19.ZF Ø 16 mm



FORO QUADRO
SQUARE HOLE

H.2000 mm.
Art. 08.001.ZF fori / hole □ 14 INT.140 mm - n°14 fori / holes
Art. 08.002.ZF fori / hole □ 16 INT.150 mm - n°13 fori / holes
Art. 08.006.01.ZF fori / hole □ 12 INT.120 mm - n°16 fori / holes



FORO TONDO
ROUND HOLE

H.2000 mm.
Art. 08.023.ZF fori / hole Ø 14 INT.140 mm - n°14 fori / holes
Art. 08.024.ZF fori / hole Ø 16 INT.150 mm - n°13 fori / holes
Art. 08.025.ZF fori / hole Ø 18 INT.160 mm - n°12 fori / holes
Art. 08.029.01.ZF fori / hole Ø 12 INT.120 mm - n°16 fori / holes
Art. 08.115.ZF fori / hole Ø 14 INT.125 mm - n°15 fori / holes
Art. 08.116.ZF fori / hole Ø 16 INT.125 mm - n°15 fori / holes



FORO QUADRO
SQUARE HOLE

INT.125
15 Fori per barra
15 Holes for bar
H.2000 mm. Foro □ 12
Art. 08.059.ZF ≠ 30 x 8
Art. 08.063.ZF ≠ 40 x 8



Piatto Mezzo Tondo /
Half-Round Flat
H.6000 mm.

Art. 12.059.01.ZF ≠ 30x8
Art. 12.063.01.ZF ≠ 40x8
Art. 12.064.01.ZF ≠ 40x10
Art. 12.066.01.ZF ≠ 50x10



Sagomato / Contoured
H.6000 mm.

Art. 12.085.ZF ≠ 50 x 14
Art. 12.085.01.ZF ≠ 40 x 12
Art. 12.085.02.ZF ≠ 45 x 12
Art. 12.085.03.ZF ≠ 60 x 12 NEW



Barra per Fascette / Collar Bars
H.4000 mm.

Art. 12.118.ZF ≠ 14x4



H.6000 mm.

Art. 12.158.ZF □ 12x12 mm.
Art. 12.159.ZF □ 14x14 mm.



Quadro Martellato /
Hammered Square
H.6000 mm.

Art. 12.182.ZF □ 12x12 mm.
Art. 12.183.ZF □ 14x14 mm.



Tubo Martellato /
Tube Hammered
H.6000 mm.

Art. 12.238.ZF □ 40x40 x 2.5 mm.
Art. 12.240.ZF □ 30x30 x 2.5 mm.



H.125 X L.60 mm.
Art. 13.077.ZF Ø 32 mm



H.155 X L.65 mm.
Art. 13.080.ZF Ø 16 mm

Nuove Borchie in Tubo / New Studs in Tube



H.39 x L.49 mm.

Art. 13.135.ZF Ø 12,5 mm
Art. 13.136.ZF Ø 14,5 mm
Art. 13.137.ZF Ø 16,5 mm



H.67 x L.40 mm.

Art. 13.138.ZF Ø 12,5 mm
Art. 13.139.ZF Ø 14,5 mm
Art. 13.140.ZF Ø 16,5 mm



Borchie Svasate /
Countersunk Ironstud
H.39 X L.40 mm.

Art. 13.137.B.ZF Ø 16,5 mm



H.67 x L. 40 mm

Art. TB.13.139.ZF Ø 14,5
Art. TB.13.140.ZF Ø 16,5



H.67 x L.40 mm.

Art. 13.142.ZF □ 12,5 mm

H.67 x L.45 mm.

Art. 13.152.ZF □ 14,5 mm



H.67 X L.45 mm.

Art. 13.148.ZF Ø 16,5 mm



H.25 x L.35 mm.

Art. 13.167.ZF Ø 12,5 mm
Art. 13.167.02.ZF Ø 16,5 mm

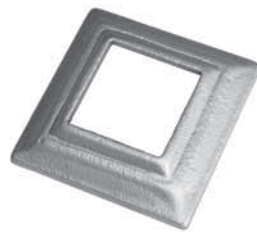

H.80 x 80 H. 20 mm.

Art. 13.319.ZF foro □ 30,5 mm
Art. 13.320.ZF foro □ 35,5 mm
Art. 13.321.ZF foro □ 40,5 mm

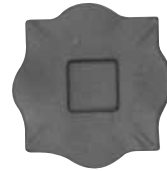

□ 100x100 mm

Art. 13.311.ZF
sede/seat □ 30x30 mm



□ 100x100 mm

Art. 13.313.ZF
foro/hole □ 30x30 mm



Ferro fuso / Cast steel
H.38 x L.40 mm

Art. CS.13.900.ZF □ 14,5



Ferro fuso / Cast steel
H.65 x L.40 mm

Art. CS.13.901.ZF □ 14,5
Art. CS.13.901.01.ZF □ 16,5

H.60 x 60 H. 20 mm.

Art. 13.322.ZF foro □ 25,5 mm
Art. 13.323.ZF foro □ 30,5 mm



Copricolonna / Post Caps

Art. 15.052.ZF □ 30x30 mm
Art. 15.053.ZF □ 40x40 mm
Art. 15.054.ZF □ 50x50 mm
Art. 15.055.ZF □ 60x60 mm

Copricolonna / Post Caps

Art. 15.056.ZF □ 80x80 mm
Art. 15.057.ZF □ 100x100 mm
Art. 15.058.ZF □ 120x120 mm
Art. 15.059.ZF □ 150x150 mm

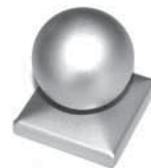
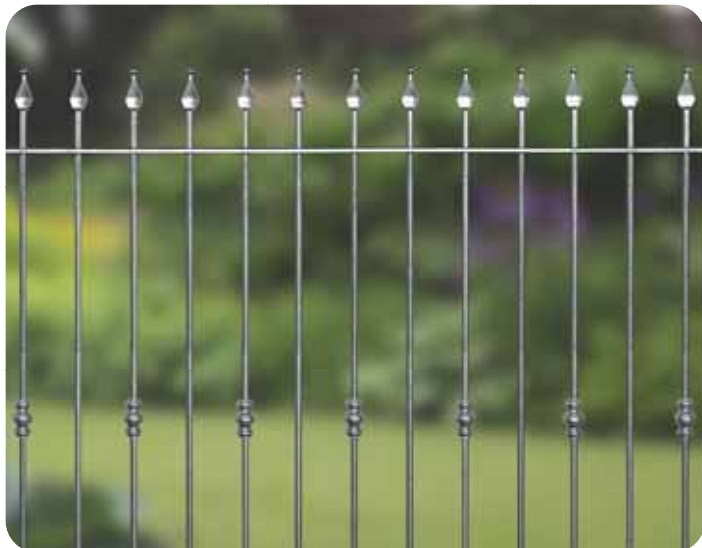

Sfera vuota / Hollow sphere

Art. 15.059.05.ZF □ 30x30 Ø 40 mm
Art. 15.059.06.ZF □ 40x40 Ø 40 mm
Art. 15.059.07.ZF □ 50x50 Ø 50 mm

Sfera vuota / Hollow sphere

Art. 15.059.08.ZF □ 60x60 Ø 60 mm
Art. 15.059.09.ZF □ 80x80 Ø 80 mm
Art. 15.059.10.ZF □ 100x100 Ø 100 mm

Liscio / Smooth

Tondo.ZF. 6x6000 mm
Tondo.ZF. 8x6000 mm
Tondo.ZF. 10x6000 mm
Tondo.ZF. 12x6000 mm

Liscio / Smooth

Tondo.ZF. 14x6000 mm
Tondo.ZF. 16x6000 mm
Tondo.ZF. 18x6000 mm
Tondo.ZF. 20x6000 mm

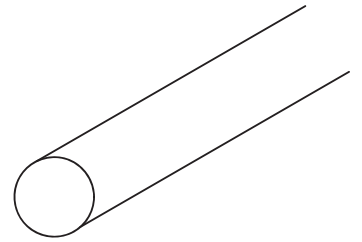
Liscio / Smooth
H.6000 mm.

Piatto.ZF ≠ 20 x 3
Piatto.ZF ≠ 20 x 4
Piatto.ZF ≠ 20 x 5
Piatto.ZF ≠ 20 x 10
Piatto.ZF ≠ 25 x 3
Piatto.ZF ≠ 25 x 4
Piatto.ZF ≠ 25 x 5

Liscio / Smooth
H.6000 mm.

Piatto.ZF ≠ 30 x 3
Piatto.ZF ≠ 30 x 4
Piatto.ZF ≠ 30 x 5
Piatto.ZF ≠ 30 x 6
Piatto.ZF ≠ 30 x 8
Piatto.ZF ≠ 30 x 10
Piatto.ZF ≠ 30 x 20

Liscio / Smooth
H.6000 mm.

Piatto.ZF ≠ 40 x 4
Piatto.ZF ≠ 40 x 5
Piatto.ZF ≠ 40 x 8
Piatto.ZF ≠ 40 x 10
Piatto.ZF ≠ 50 x 5
Piatto.ZF ≠ 50 x 8
Piatto.ZF ≠ 50 x 10
Piatto.ZF ≠ 60 x 5

Liscio / Smooth
H.6000 mm.

Piatto.ZF ≠ 80 x 5
Piatto.ZF ≠ 100 x 5 **NEW**

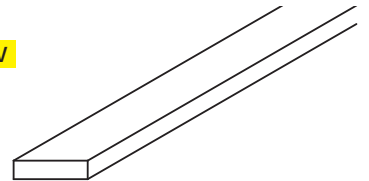
Liscio / Smooth
H.6000 mm.

Angolare.ZF □ 20 x 20 x 3
Angolare.ZF □ 25 x 25 x 4
Angolare.ZF □ 30 x 30 x 3
Angolare.ZF □ 30 x 30 x 5
Angolare.ZF □ 35 x 35 x 5

Liscio / Smooth
H.6000 mm.

Angolare.ZF □ 40 x 40 x 5
Angolare.ZF □ 45 x 45 x 5
Angolare.ZF □ 50 x 50 x 5
Angolare.ZF □ 60 x 60 x 5

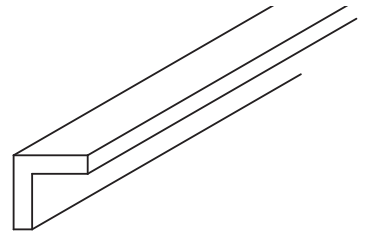
Liscio / Smooth
H.6000 mm.

Profilo.ZF T 30 x 30 x 4
Profilo.ZF T 35 x 35 x 4,5
Profilo.ZF T 40 x 40 x 5
Profilo.ZF T 50 x 50 x 6

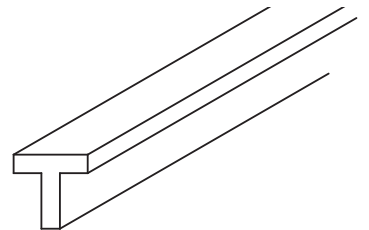
Liscio / Smooth

Quadro.ZF □ 14x6000 mm
Quadro.ZF □ 16x6000 mm

Liscio / Smooth

Quadro.ZF □ 10x6000 mm
Quadro.ZF □ 12x6000 mm
Quadro.ZF □ 20x6000 mm

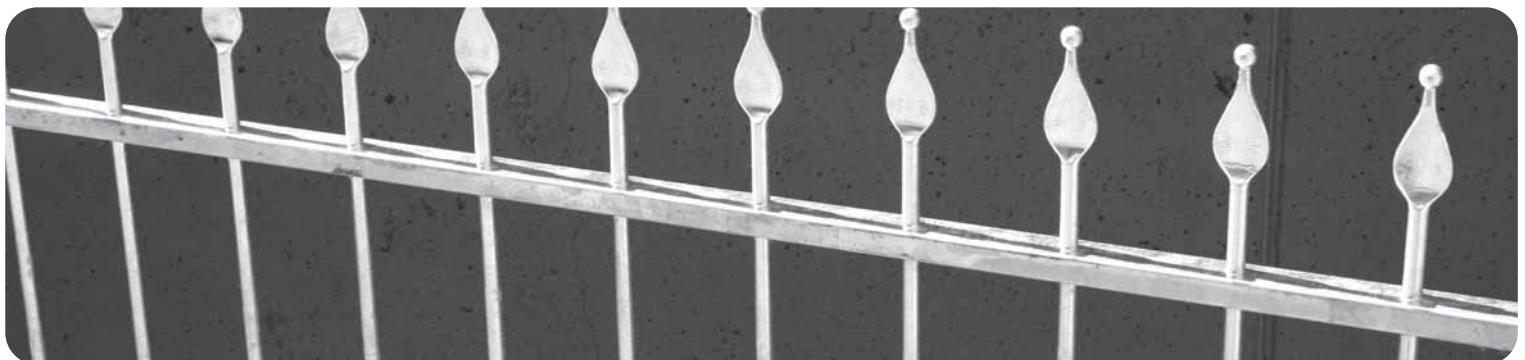
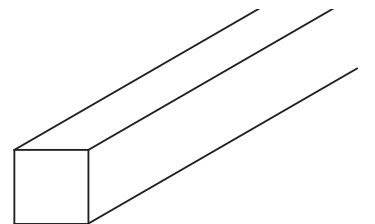

Art. LB1000X2000.20/10.ZF	Lamiera Bugnata / <i>Teardrop patterned steel sheet</i> 1000x2000mm sp. 20/10
Art. LB1000X2000.25/10.ZF	Lamiera Bugnata / <i>Teardrop patterned steel sheet</i> 1000x2000mm sp. 25/10
Art. LB1000X2000.30/10.ZF	Lamiera Bugnata / <i>Teardrop patterned steel sheet</i> 1000x2000mm sp. 30/10
Art. LB1250X2500.20/10.ZF	Lamiera Bugnata / <i>Teardrop patterned steel sheet</i> 1250x2500mm sp. 20/10
Art. LB1250X2500.25/10.ZF	Lamiera Bugnata / <i>Teardrop patterned steel sheet</i> 1250x2500mm sp. 25/10
Art. LB1250X2500.30/10.ZF	Lamiera Bugnata / <i>Teardrop patterned steel sheet</i> 1250x2500mm sp. 30/10
Art. LB1500X3000.25/10.ZF	Lamiera Bugnata / <i>Teardrop patterned steel sheet</i> 1500x3000mm sp. 25/10
Art. LB1500X3000.30/10.ZF	Lamiera Bugnata / <i>Teardrop patterned steel sheet</i> 1500x3000mm sp. 30/10

*A seconda delle diponibilita' del magazzino la bugna puo' essere tronca oppure affusolata
Depending on the availability of the warehouse the drop could be truncated or tapered*

Lamiera Bugnata Tronca /
Teardrop patterned steel sheet (truncated drop)

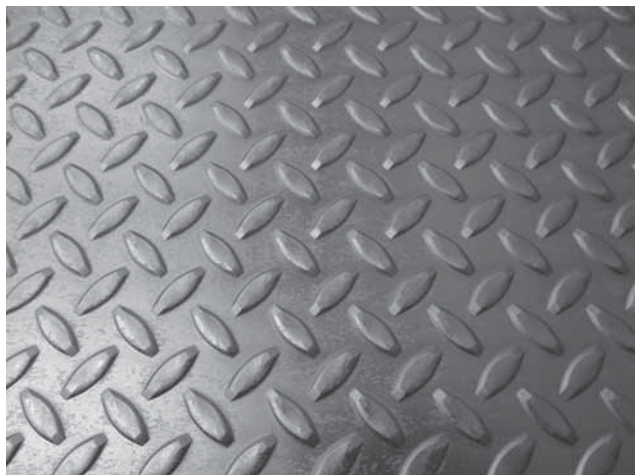

Lamiera Bugnata Affusolata /
Teardrop patterned steel sheet (tapered drop)

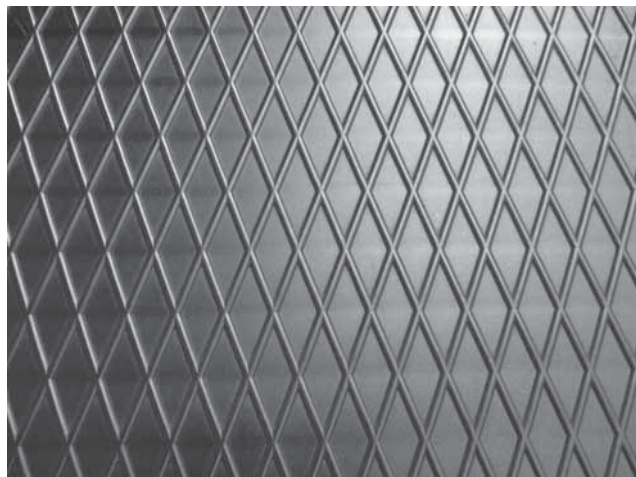

Art. LS1000X2000.30/10.ZF
Lamiera Striata / *Diamond patterned steel sheet*
1000x2000mm sp. 30/10

Art. LS1250X2500.30/10.ZF
Lamiera Striata / *Diamond patterned steel sheet*
1250x2500mm sp. 30/10

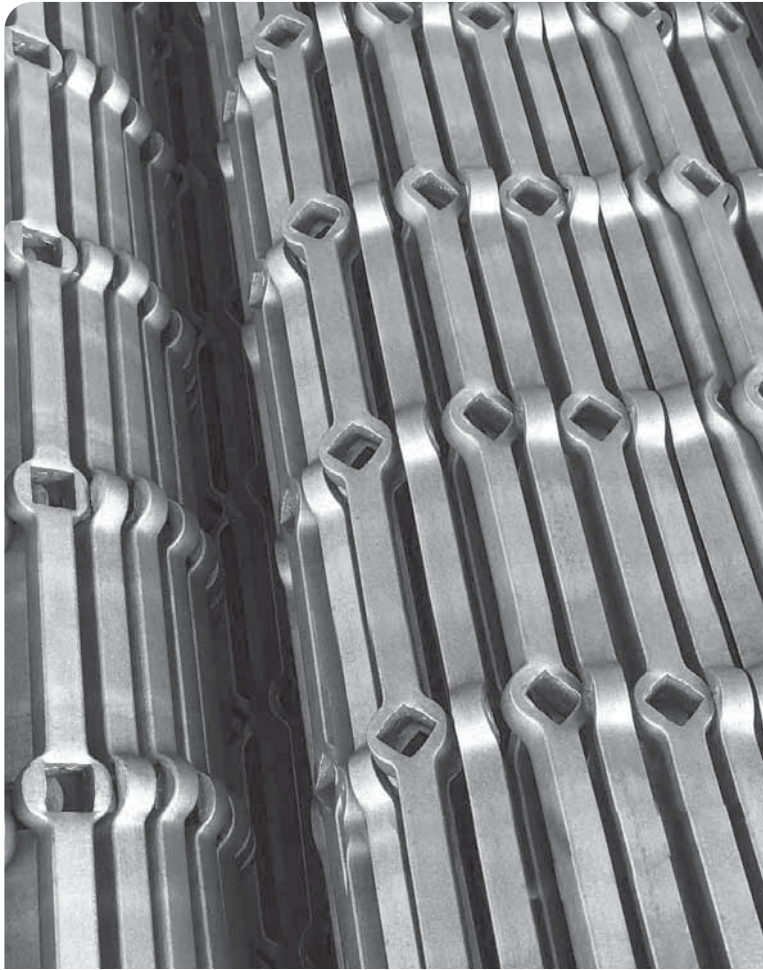

Tutte le parti di questo catalogo - foto comprese - sono di proprietà Euro-Fer. La riproduzione, anche parziale, è vietata in ogni forma e con ogni mezzo. / Every part of this catalogue - photos included - is Euro-Fer's property. All forms of copying are strictly prohibited.



sezione ferro iron section	tipo ferro iron type	codice code	interasse centre distance	nr. fori nr. of holes	tipo fori kind of holes	luce hole to hole	trattamento finishing
■ 14x14	liscio / smooth	08.001	140 mm	14 fori / holes	□ 14x14	126 mm	grezzo / raw
■ 16x16	liscio / smooth	08.002	150 mm	13 fori / holes	□ 16x16	134 mm	grezzo / raw
■ 18x18	liscio / smooth	08.003	160 mm	12 fori / holes	□ 18x18	142 mm	grezzo / raw
■ 20x20	liscio / smooth	08.004	170 mm	11 fori / holes	□ 20x20	150 mm	grezzo / raw
■ 22x22	liscio / smooth	08.005	170 mm	11 fori / holes	□ 22x22	148 mm	grezzo / raw
■ 25x25	liscio / smooth	08.006	180 mm	10 fori / holes	□ 25x25	155 mm	grezzo / raw
■ 12x12	liscio / smooth	08.006.01	120 mm	16 fori / holes	□ 12x12	108 mm	grezzo / raw



■ 14x14	liscio / smooth	08.007	140 mm	14 fori / holes	◇ 14x14 sullo spigolo / on the edge	120 mm	grezzo / raw
■ 16x16	liscio / smooth	08.008	150 mm	13 fori / holes	◇ 16x16 sullo spigolo / on the edge	127 mm	grezzo / raw
■ 18x18	liscio / smooth	08.009	160 mm	12 fori / holes	◇ 18x18 sullo spigolo / on the edge	135 mm	grezzo / raw
■ 20x20	liscio / smooth	08.010	170 mm	11 fori / holes	◇ 20x20 sullo spigolo / on the edge	142 mm	grezzo / raw
■ 22x22	liscio / smooth	08.011	170 mm	11 fori / holes	◇ 22x22 sullo spigolo / on the edge	139 mm	grezzo / raw
■ 25x25	liscio / smooth	08.012	180 mm	10 fori / holes	◇ 25x25 sullo spigolo / on the edge	145 mm	grezzo / raw



■ 14x14	liscio / smooth	08.013	140 mm	14 fori / holes	◇ 14x14	120 mm	grezzo / raw
■ 16x16	liscio / smooth	08.014	150 mm	13 fori / holes	◇ 16x16	127 mm	grezzo / raw
■ 18x18	liscio / smooth	08.015	160 mm	12 fori / holes	◇ 18x18	135 mm	grezzo / raw
■ 20x20	liscio / smooth	08.016	170 mm	11 fori / holes	◇ 20x20	142 mm	grezzo / raw
■ 22x22	liscio / smooth	08.017	170 mm	11 fori / holes	◇ 22x22	139 mm	grezzo / raw
■ 25x25	liscio / smooth	08.018	180 mm	10 fori / holes	◇ 25x25	145 mm	grezzo / raw



Ø 14	liscio / smooth	08.019	140 mm	14 fori / holes	θ 14x26 mm ovale / oval		grezzo / raw
Ø 16	liscio / smooth	08.020	150 mm	13 fori / holes	θ 16x28 mm ovale / oval		grezzo / raw
Ø 18	liscio / smooth	08.021	160 mm	12 fori / holes	θ 18x30 mm ovale / oval		grezzo / raw
Ø 20	liscio / smooth	08.022	170 mm	11 fori / holes	θ 20x33 mm ovale / oval		grezzo / raw



Ø 14	liscio / smooth	08.023	140 mm	14 fori / holes	Ø 14	126 mm	grezzo / raw
Ø 16	liscio / smooth	08.024	150 mm	13 fori / holes	Ø 16	126 mm	grezzo / raw
Ø 18	liscio / smooth	08.025	160 mm	12 fori / holes	Ø 18	142 mm	grezzo / raw
Ø 20	liscio / smooth	08.026	170 mm	11 fori / holes	Ø 20	150 mm	grezzo / raw
Ø 22	liscio / smooth	08.027	170 mm	11 fori / holes	Ø 22	148 mm	grezzo / raw
Ø 25	liscio / smooth	08.028	180 mm	10 fori / holes	Ø 25	155 mm	grezzo / raw
Ø 30	liscio / smooth	08.029	200 mm	9 fori / holes	Ø 30	170 mm	grezzo / raw
Ø 12	liscio / smooth	08.029.01	120 mm	16 fori / holes	Ø 12	108 mm	grezzo / raw



sezione ferro iron section	tipo ferro iron type	codice code	interasse centre distance	nr. fori nr. of holes	tipo fori kind of holes	luce hole to hole	trattamento finishing
■ 14x14	liscio / smooth	08.106	140 mm	14 fori / holes	□ 24x15 rettangolo / rectangular		grezzo / raw
■ 16x16	liscio / smooth	08.107	150 mm	13 fori / holes	□ 30x17 rettangolo / rectangular		grezzo / raw
■ 18x18	liscio / smooth	08.108	160 mm	12 fori / holes	□ 31x19 rettangolo / rectangular		grezzo / raw
■ 20x20	liscio / smooth	08.109	170 mm	11 fori / holes	□ 33x21 rettangolo / rectangular		grezzo / raw



Ø 14	corteccia / bark	08.109.01	140 mm	14 fori / holes	Ø 14	126 mm	grezzo / raw
Ø 16	corteccia / bark	08.109.02	150 mm	13 fori / holes	Ø 16	126 mm	grezzo / raw
Ø 18	corteccia / bark	08.109.03	160 mm	12 fori / holes	Ø 18	142 mm	grezzo / raw
Ø 20	corteccia / bark	08.109.04	170 mm	11 fori / holes	Ø 20	150 mm	grezzo / raw
Ø 22	corteccia / bark	08.109.05	170 mm	11 fori / holes	Ø 22	148 mm	grezzo / raw



■ 12x12	martellato / hammered	08.110	120 mm	16 fori / holes	□ 12x12	108 mm	grezzo / raw
■ 14x14	martellato / hammered	08.111	140 mm	14 fori / holes	□ 14x14	126 mm	grezzo / raw
■ 16x16	martellato / hammered	08.112	150 mm	13 fori / holes	□ 16x16	134 mm	grezzo / raw
■ 18x18	martellato / hammered	08.113	160 mm	12 fori / holes	□ 18x18	142 mm	grezzo / raw
■ 20x20	martellato / hammered	08.114	170 mm	11 fori / holes	□ 20x20	150 mm	grezzo / raw



■ 14x14	corteccia / bark	08.114.01	140 mm	14 fori / holes	□ 14x14	126 mm	grezzo / raw
■ 16x16	corteccia / bark	08.114.02	150 mm	13 fori / holes	□ 16x16	134 mm	grezzo / raw



■ 14x14	corteccia / bark	08.114.10	140 mm	14 fori / holes	◇14x14	120 mm	grezzo / raw
■ 16x16	corteccia / bark	08.114.11	150 mm	13 fori / holes	◇16x16	127 mm	grezzo / raw



■ 14x14	martellato / hammered	08.114.20	140 mm	14 fori / holes	◇14x14 sullo spigolo / on the edge	120 mm	grezzo / raw
■ 16x16	martellato / hammered	08.114.21	150 mm	13 fori / holes	◇16x16 sullo spigolo / on the edge	127 mm	grezzo / raw



■ 12x12	in spigolo / edged	08.114.30	120 mm	16 fori / holes	□ 12x12	108 mm	grezzo / raw
■ 14x14	in spigolo / edged	08.114.31	140 mm	14 fori / holes	□ 14x14	126 mm	grezzo / raw
■ 16x16	in spigolo / edged	08.114.32	150 mm	13 fori / holes	□ 16x16	134 mm	grezzo / raw
■ 18x18	in spigolo / edged	08.114.33	160 mm	12 fori / holes	□ 18x18	142 mm	grezzo / raw



Ø 14	liscio / smooth	08.115	125 mm	15 fori / holes	Ø 14	111 mm	grezzo / raw
Ø 14	liscio / smooth	08.115.01	130 mm	14 fori / holes	Ø 14	116 mm	grezzo / raw
Ø 16	liscio / smooth	08.116	125 mm	15 fori / holes	Ø 16	109 mm	grezzo / raw
Ø 16	liscio / smooth	08.116.01	160 mm	12 fori / holes	Ø 16	144 mm	grezzo / raw
Ø 18	liscio / smooth	08.117	128 mm	14 fori / holes	Ø 18	110 mm	grezzo / raw
Ø 20	liscio / smooth	08.118	130 mm	13 fori / holes	Ø 20	110 mm	grezzo / raw



sezione ferro iron section	tipo ferro iron type	codice code	interasse centre distance	nr. fori nr. of holes	tipo fori kind of holes	luce hole to hole	trattamento finishing
■ 14x14	liscio / smooth	08.119	125 mm	15 fori / holes	□ 14x14	111 mm	grezzo / raw
■ 14x14	liscio / smooth	08.119.01	125 mm	14 fori / holes	□ 14x14	111 mm.	grezzo / raw
■ 16x16	liscio / smooth	08.120	125 mm	15 fori / holes	□ 16x16	109 mm	grezzo / raw
■ 16x16	liscio / smooth	08.120.01	135 mm	14 fori / holes	□ 16x16	119 mm	grezzo / raw
■ 18x18	liscio / smooth	08.121	128 mm	14 fori / holes	□ 18x18	110 mm	grezzo / raw
■ 20x20	liscio / smooth	08.122	130 mm	13 fori / holes	□ 20x20	110 mm	grezzo / raw



■ 14x14	liscio / smooth	08.123	128 mm	14 fori / holes	◇14x14 sullo spigolo / on the edge	108 mm	grezzo / raw
■ 16x16	liscio / smooth	08.124	130 mm	14 fori / holes	◇16x16 sullo spigolo / on the edge	107 mm	grezzo / raw
■ 18x18	liscio / smooth	08.125	132 mm	14 fori / holes	◇18x18 sullo spigolo / on the edge	107 mm	grezzo / raw
■ 20x20	liscio / smooth	08.126	134 mm	13 fori / holes	◇20x20 sullo spigolo / on the edge	106 mm	grezzo / raw



■ 14x14	liscio / smooth	08.127	128 mm	14 fori / holes	◇14x14	108 mm	grezzo / raw
■ 14x14	liscio / smooth	08.127.01	135 mm	14 fori / holes	◇14x14	115 mm	grezzo / raw
■ 16x16	liscio / smooth	08.128	130 mm	14 fori / holes	◇16x16	107 mm	grezzo / raw
■ 16x16	liscio / smooth	08.128.01	135 mm	14 fori / holes	◇16x16	112 mm	grezzo / raw
■ 16x16	liscio / smooth	08.128.02	125 mm	15 fori / holes	◇16x16	102 mm	grezzo / raw
■ 18x18	liscio / smooth	08.129	132 mm	14 fori / holes	◇18x18	107 mm	grezzo / raw
■ 18x18	liscio / smooth	08.129.01	135 mm	14 fori / holes	◇18x18	110 mm	grezzo / raw
■ 20x20	liscio / smooth	08.130	135 mm	13 fori / holes	◇20x20	107 mm	grezzo / raw



Ø 14	corteccia / bark	08.130.01	125 mm	15 fori / holes	Ø 14	111 mm	grezzo / raw
Ø 16	corteccia / bark	08.130.02	125 mm	15 fori / holes	Ø 16	109 mm	grezzo / raw
Ø 18	corteccia / bark	08.130.03	128 mm	14 fori / holes	Ø 18	110 mm	grezzo / raw



■ 16x16	liscio / smooth	08.131	125 mm	15 fori / holes	□ 14x14	111 mm	grezzo / raw
---------	-----------------	---------------	--------	-----------------	---------	--------	--------------



Ø 16	liscio / smooth	08.132	125 mm	15 fori / holes	Ø 14	111 mm	grezzo / raw
------	-----------------	---------------	--------	-----------------	------	--------	--------------



BARRE FORATE SABBIAE / SANDBLASTED HOLED BARS

sezione ferro iron section	tipo ferro iron type	codice code	interasse centre distance	nr. fori nr. of holes	tipo fori kind of holes	luce hole to hole	trattamento finishing
■ 12x12	liscio / smooth	08.133	120 mm	16 fori / holes	□ 12x12	108 mm	sabbiato / sandblasted
■ 14x14	liscio / smooth	08.134	140 mm	14 fori / holes	□ 14x14	126 mm	sabbiato / sandblasted
■ 16x16	liscio / smooth	08.135	150 mm	13 fori / holes	□ 16x16	134 mm	sabbiato / sandblasted
■ 18x18	liscio / smooth	08.136	160 mm	12 fori / holes	□ 18x18	142 mm	sabbiato / sandblasted
■ 20x20	liscio / smooth	08.137	170 mm	11 fori / holes	□ 20x20	150 mm	sabbiato / sandblasted
■ 22x22	liscio / smooth	08.138	170 mm	11 fori / holes	□ 22x22	148 mm	sabbiato / sandblasted
■ 25x25	liscio / smooth	08.139	180 mm	10 fori / holes	□ 25x25	155 mm	sabbiato / sandblasted



BARRE FORATE SABBIAE / SANDBLASTED HOLED BARS

■ 14x14	liscio / smooth	08.140	140 mm	14 fori / holes	◇ 14x14 sullo spigolo / on the edge	120 mm	sabbiato / sandblasted
■ 16x16	liscio / smooth	08.141	150 mm	13 fori / holes	◇ 16x16 sullo spigolo / on the edge	127 mm	sabbiato / sandblasted
■ 18x18	liscio / smooth	08.142	160 mm	12 fori / holes	◇ 18x18 sullo spigolo / on the edge	135 mm	sabbiato / sandblasted
■ 20x20	liscio / smooth	08.143	170 mm	11 fori / holes	◇ 20x20 sullo spigolo / on the edge	142 mm	sabbiato / sandblasted
■ 22x22	liscio / smooth	08.144	170 mm	11 fori / holes	◇ 22x22 sullo spigolo / on the edge	139 mm	sabbiato / sandblasted
■ 25x25	liscio / smooth	08.145	180 mm	10 fori / holes	◇ 25x25 sullo spigolo / on the edge	145 mm	sabbiato / sandblasted



BARRE FORATE SABBIAE / SANDBLASTED HOLED BARS

■ 14x14	liscio / smooth	08.146	140 mm	14 fori / holes	◇ 14x14	120 mm	sabbiato / sandblasted
■ 16x16	liscio / smooth	08.147	150 mm	13 fori / holes	◇ 16x16	127 mm	sabbiato / sandblasted
■ 18x18	liscio / smooth	08.148	160 mm	12 fori / holes	◇ 18x18	135 mm	sabbiato / sandblasted
■ 20x20	liscio / smooth	08.149	170 mm	11 fori / holes	◇ 20x20	142 mm	sabbiato / sandblasted
■ 22x22	liscio / smooth	08.150	170 mm	11 fori / holes	◇ 22x22	139 mm	sabbiato / sandblasted
■ 25x25	liscio / smooth	08.151	180 mm	10 fori / holes	◇ 25x25	145 mm	sabbiato / sandblasted



BARRE FORATE SABBIAE / SANDBLASTED HOLED BARS

Ø 14	liscio / smooth	08.152	140 mm	14 fori / holes	⊖ 14x26 mm ovale / oval		sabbiato / sandblasted
Ø 16	liscio / smooth	08.153	150 mm	13 fori / holes	⊖ 16x28 mm ovale / oval		sabbiato / sandblasted
Ø 18	liscio / smooth	08.154	160 mm	12 fori / holes	⊖ 18x30 mm ovale / oval		sabbiato / sandblasted
Ø 20	liscio / smooth	08.155	170 mm	11 fori / holes	⊖ 20x33 mm ovale / oval		sabbiato / sandblasted

BARRE FORATE SABBIASTE HOLED BARS SAND - BLASTED



BARRE FORATE SABBIASTE / SANDBLASTED HOLED BARS

sezione ferro iron section	tipo ferro iron type	codice code	interasse centre distance	nr. fori nr. of holes	tipo fori kind of holes	luce hole to hole	trattamento finishing
Ø 12	liscio / smooth	08.156	120 mm	16 fori / holes	Ø 12	108 mm	sabbiato / sandblasted
Ø 14	liscio / smooth	08.157	140 mm	14 fori / holes	Ø 14	126 mm	sabbiato / sandblasted
Ø 16	liscio / smooth	08.158	150 mm	13 fori / holes	Ø 16	126 mm	sabbiato / sandblasted
Ø 18	liscio / smooth	08.159	160 mm	12 fori / holes	Ø 18	142 mm	sabbiato / sandblasted
Ø 20	liscio / smooth	08.160	170 mm	11 fori / holes	Ø 20	150 mm	sabbiato / sandblasted
Ø 22	liscio / smooth	08.161	170 mm	11 fori / holes	Ø 22	148 mm	sabbiato / sandblasted
Ø 25	liscio / smooth	08.162	180 mm	10 fori / holes	Ø 25	155 mm	sabbiato / sandblasted
Ø 30	liscio / smooth	08.163	200 mm	9 fori / holes	Ø 30	170 mm	sabbiato / sandblasted
Ø 14	liscio / smooth	08.164	125 mm	15 fori / holes	Ø 14	111 mm	sabbiato / sandblasted
Ø 14	liscio / smooth	08.164.01	130 mm	14 fori / holes	Ø 14	116 mm	sabbiato / sandblasted
Ø 16	liscio / smooth	08.165	125 mm	15 fori / holes	Ø 16	109 mm	sabbiato / sandblasted
Ø 16	liscio / smooth	08.165.01	160 mm	12 fori / holes	Ø 16	144 mm	sabbiato / sandblasted
Ø 18	liscio / smooth	08.166	128 mm	14 fori / holes	Ø 18	110 mm	sabbiato / sandblasted
Ø 20	liscio / smooth	08.167	130 mm	13 fori / holes	Ø 20	110 mm	sabbiato / sandblasted



BARRE FORATE SABBIASTE / SANDBLASTED HOLED BARS

■ 14x14	liscio / smooth	08.168	125 mm	15 fori / holes	□ 14x14	111 mm	sabbiato / sandblasted
■ 14x14	liscio / smooth	08.168.01	125 mm	14 fori / holes	□ 14x14	111 mm.	sabbiato / sandblasted
■ 16x16	liscio / smooth	08.169	125 mm	15 fori / holes	□ 16x16	109 mm	sabbiato / sandblasted
■ 16x16	liscio / smooth	08.169.01	135 mm	14 fori / holes	□ 16x16	119 mm	sabbiato / sandblasted
■ 18x18	liscio / smooth	08.170	128 mm	14 fori / holes	□ 18x18	110 mm	sabbiato / sandblasted
■ 20x20	liscio / smooth	08.171	130 mm	13 fori / holes	□ 20x20	110 mm	sabbiato / sandblasted



BARRE FORATE SABBIASTE / SANDBLASTED HOLED BARS

■ 14x14	liscio / smooth	08.172	128 mm	14 fori / holes	◇14x14 sullo spigolo / on the edge	108 mm	sabbiato / sandblasted
■ 16x16	liscio / smooth	08.173	130 mm	14 fori / holes	◇16x16 sullo spigolo / on the edge	107 mm	sabbiato / sandblasted
■ 18x18	liscio / smooth	08.174	132 mm	14 fori / holes	◇18x18 sullo spigolo / on the edge	107 mm	sabbiato / sandblasted
■ 20x20	liscio / smooth	08.175	134 mm	13 fori / holes	◇20x20 sullo spigolo / on the edge	106 mm	sabbiato / sandblasted



BARRE FORATE SABBIASTE / SANDBLASTED HOLED BARS

sezione ferro iron section	tipo ferro iron type	codice code	interasse centre distance	nr. fori nr. of holes	tipo fori kind of holes	luce hole to hole	trattamento finishing
■ 14x14	liscio / smooth	08.176	128 mm	14 fori / holes	◇14x14	108 mm	sabbiato / sandblasted
■ 14x14	liscio / smooth	08.176.01	135 mm	14 fori / holes	◇14x14	115 mm	sabbiato / sandblasted
■ 16x16	liscio / smooth	08.177	130 mm	14 fori / holes	◇16x16	107 mm	sabbiato / sandblasted
■ 16x16	liscio / smooth	08.177.01	135 mm	14 fori / holes	◇16x16	112 mm	sabbiato / sandblasted
■ 16x16	liscio / smooth	08.177.02	125 mm	15 fori / holes	◇16x16	102 mm	sabbiato / sandblasted
■ 18x18	liscio / smooth	08.178	132 mm	14 fori / holes	◇18x18	107 mm	sabbiato / sandblasted
■ 18x18	liscio / smooth	08.178.01	135 mm	14 fori / holes	◇18x18	110 mm	sabbiato / sandblasted
■ 20x20	liscio / smooth	08.179	135 mm	13 fori / holes	◇20x20	107 mm	sabbiato / sandblasted



BARRE FORATE SABBIASTE / SANDBLASTED HOLED BARS

■ 16x16	liscio / smooth	08.180	125 mm	15 fori / holes	□ 14x14	111 mm	sabbiato / sandblasted
---------	-----------------	---------------	--------	-----------------	---------	--------	------------------------



BARRE FORATE SABBIASTE / SANDBLASTED HOLED BARS

Ø 16	liscio / smooth	08.181	125 mm	15 fori / holes	Ø 14	111 mm	sabbiato / sandblasted
------	-----------------	---------------	--------	-----------------	------	--------	------------------------





LASERFER

BY EUROFER

LASERFER TRASFORMA LE IDEE IN TAGLI DI LUCE.

Per migliorare la capacità di essere sempre al servizio del cliente, EUROFER ha deciso di ampliare la propria gamma con gli articoli tagliati al laser e con una tecnologia che permetterà ai disegni di prendere forma.

Oltre agli elementi tradizionali quali piastre, terminali ed ornamenti, sono proposti pannelli per recinzioni, per cancelli, per portali o per decoro.

Accanto alle nuove tematiche proposte dai Designers in questo catalogo, sulle superfici come il ferro, l'acciaio inossidabile e il corten si possono realizzare figure o soggetti a piacere. Il ferro della lastra può essere zincato o colorato, LASERFER propone quindi un prodotto finito e di sicuro effetto.

LASERFER TURNS IDEAS INTO DESIGNS OF LIGHT.

To improve the capacity of always being about customer service, EUROFER has decided to extend its range with laser-cut products thanks to a technology that will allow drawings to take shape.

Besides traditional elements like plates, frets and ornaments for railings, there are also panels for enclosures, gates, portals or just for pure aesthetic.

Next to Designers' new issues in this catalogue, for what concerns surfaces like iron, stainless steel and corten, it's possible to create new figures or objects as desired.

Sheet iron can be galvanised or coloured, LASERFER proposes a finished product with a huge impact.

- 1** Scegli, nello schema della pagina seguente, i pannelli che vuoi ordinare.
In the pattern in the following page, choose the panels corresponding to your gate /fencing.

ESEMPIO / EXAMPLE: CANCELLO PRINCIPALE E RECINZIONE / FRONT GATE AND FENCING

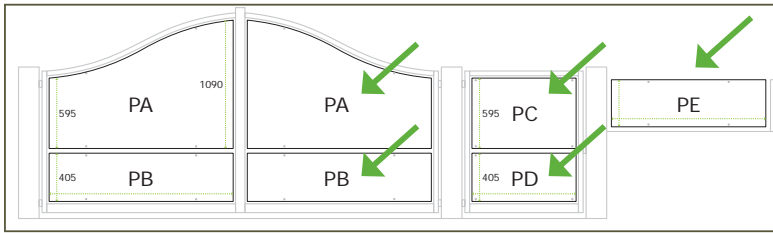

CANCELLO PRINCIPALE:
 PANNELLO PA DESTRO E SINISTRO
 PANNELLO PB DESTRO E SINISTRO
FRONT GATE:
 PANEL PA RIGHT AND LEFT
 PANEL PB RIGHT AND LEFT

CANCELLETTO PEDONALE:
 PANNELLO PC - PANNELLO PD
PEDESTRIAN GATE:
 PANEL PC - PANEL PD

RECINZIONE: PANNELLO PE
FENCING: PANEL PE

- 2** Scegli poi il decoro nelle pagine seguenti.
Select the pattern in the following pages.

ESEMPIO / EXAMPLE: PARALLELOS LINE 07 - 09 - 10

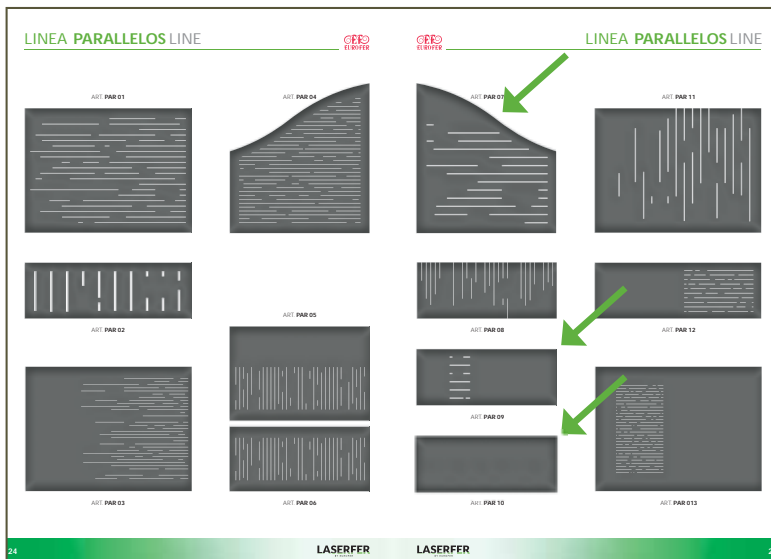

- 3** Indica poi:
 TIPO DI PANNELLO SCELTO, DECORO E QUANTITÀ
Please indicate: KIND OF PANEL, DECORATION AND QUANTITY

ESEMPIO / EXAMPLE:

PA destro / right	PARALLELOS LINE 07	n° 1
PA sinistro / left	PARALLELOS LINE 07	n° 1
PB destro / right	PARALLELOS LINE 10	n° 1
PB sinistro / left	PARALLELOS LINE 10	n° 1
PC	PARALLELOS LINE 07	n° 1
PD	PARALLELOS LINE 10	n° 1
PE	PARALLELOS LINE 09	n° 2

- 4** Completa il tuo ordine indicando lo spessore della lamiera, il tipo di materiale e la finitura.
Complete your order with: thickness plate, material type and finish.

Ed ecco visualizzato il Vostro ordine! / And now your plan:

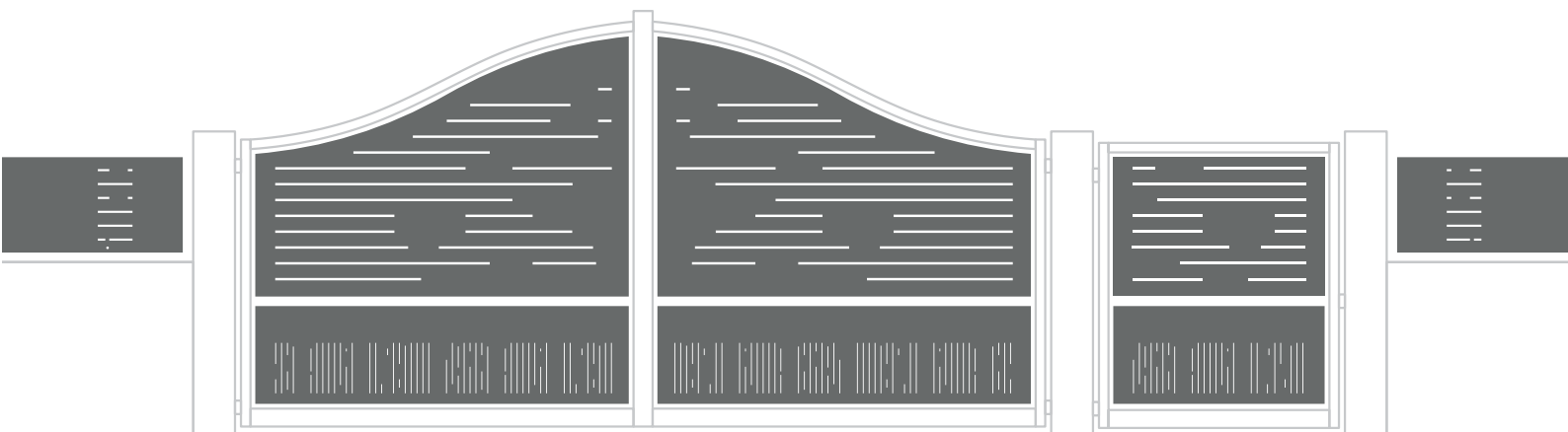

La fattibilità della realizzazione del decoro va verificata in base a dimensioni e spessori della lastra. / The feasibility of making certain decorations may depend on plate size and thickness.

Tutte le parti di questo catalogo - foto comprese - sono di proprietà Euro-Fer. La riproduzione, anche parziale, è vietata in ogni forma e con ogni mezzo. / Every part of this catalogue - photos included - is Euro-Fer's property. All forms of copying are strictly prohibited.

CODICI - DIMENSIONI / CODES - DIMENSIONS

PA

Decoro / Design _____
N° pz. / N° pcs. _____

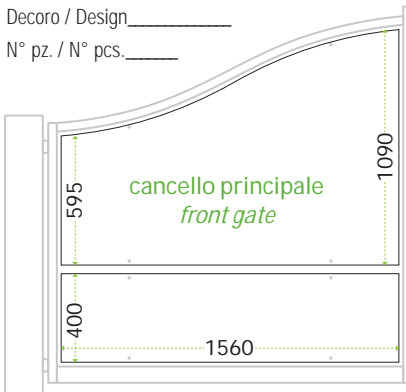

PA

Decoro / Design _____
N° pz. / N° pcs. _____

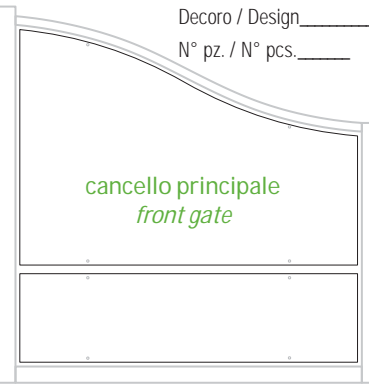

PC

Decoro / Design _____
N° pz. / N° pcs. _____

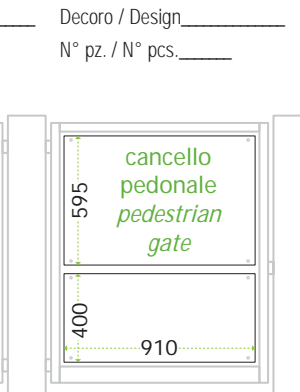

PE

Decoro / Design _____
N° pz. / N° pcs. _____

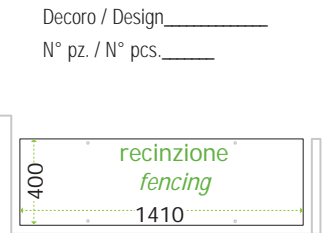

PB

Decoro / Design _____
N° pz. / N° pcs. _____

PB

Decoro / Design _____
N° pz. / N° pcs. _____

PD

Decoro / Design _____
N° pz. / N° pcs. _____

PF

Decoro / Design _____
N° pz. / N° pcs. _____

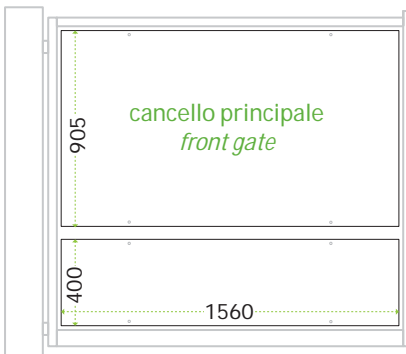

PF

Decoro / Design _____
N° pz. / N° pcs. _____

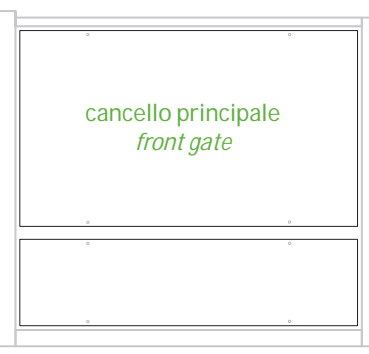

PG

Decoro / Design _____
N° pz. / N° pcs. _____

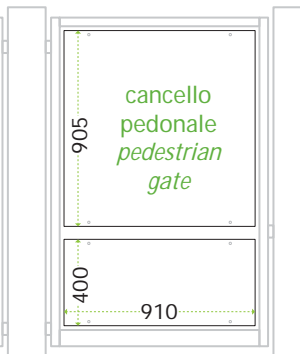

PH

Decoro / Design _____
N° pz. / N° pcs. _____

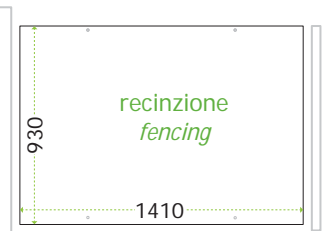

PB

Decoro / Design _____
N° pz. / N° pcs. _____

PB

Decoro / Design _____
N° pz. / N° pcs. _____

PD

Decoro / Design _____
N° pz. / N° pcs. _____

DECORAZIONE / DESIGN



Scegli i decori Laserfer
Choose a Laserfer design

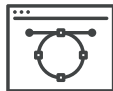

Allega il tuo file .dxf
Send us your .dxf file



Allega il tuo disegno
Send us your sketch

SPESSORI - MATERIALI E FINITURE / THICKNESS - MATERIALS AND FINISHING

Spessore Lamiera
Sheet Thickness

- 20/10
- 25/10
- 30/10
- 40/10
-

Materiale / Material
Finitura / Finishing

- FERRO GREZZO / RAW IRON
- PRE-ZINCATO / GALVANIZED
- PRE-ZINCATO VERNICIATO
PRE-GALVANIZED POWDER COATED

- COR-TEN
- INOX 304
- INOX 316



RAL.....

For specific questions regarding finish, colouring, or technical topics, please contact your local sales office.

La fattibilità della realizzazione del decoro va verificata in base a dimensioni e spessori della lastra. / The feasibility of making certain decorations may depend on plate size and thickness. Tutte le parti di questo catalogo - foto comprese - sono di proprietà Euro-Fer. La riproduzione, anche parziale, è vietata in ogni forma e con ogni mezzo. / Every part of this catalogue - photos included - is Euro-Fer's property. All forms of copying are strictly prohibited.

CODICI - DIMENSIONI / CODES - DIMENSIONS

PA

Decoro / Design _____
N° pz. / N° pcs. _____

PA

Decoro / Design _____
N° pz. / N° pcs. _____

PC

Decoro / Design _____
N° pz. / N° pcs. _____

PE

Decoro / Design _____
N° pz. / N° pcs. _____

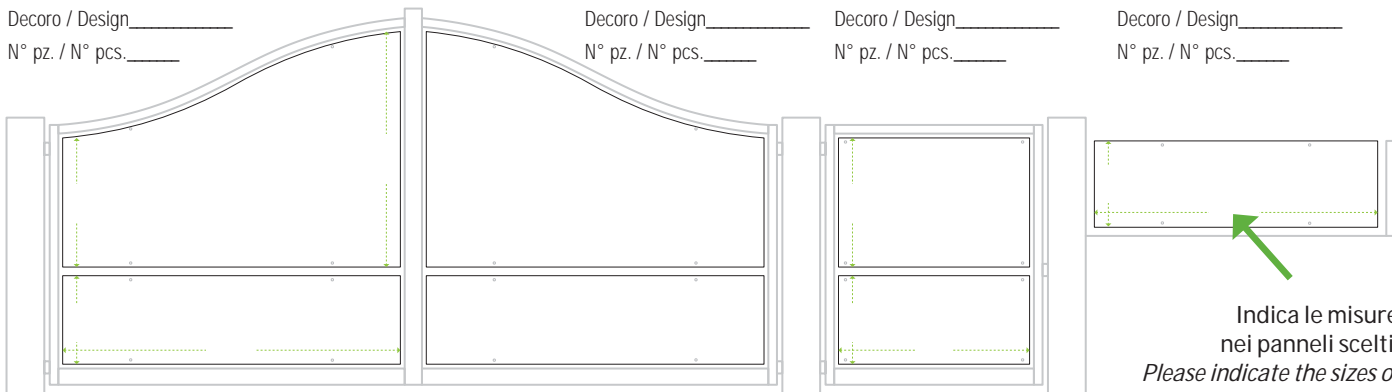

PB

Decoro / Design _____
N° pz. / N° pcs. _____

PB

Decoro / Design _____
N° pz. / N° pcs. _____

PD

Decoro / Design _____
N° pz. / N° pcs. _____

PF

Decoro / Design _____
N° pz. / N° pcs. _____

PF

Decoro / Design _____
N° pz. / N° pcs. _____

PG

Decoro / Design _____
N° pz. / N° pcs. _____

PH

Decoro / Design _____
N° pz. / N° pcs. _____

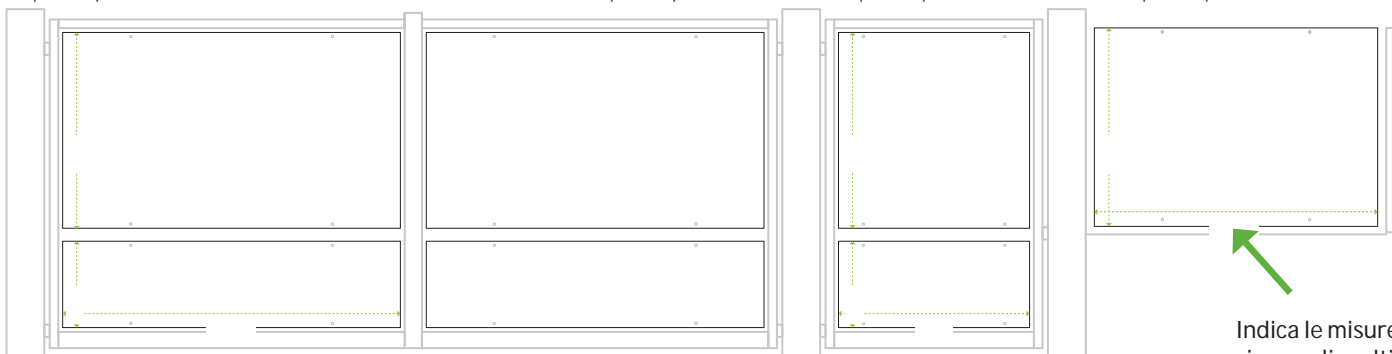

PB

Decoro / Design _____
N° pz. / N° pcs. _____

PB

Decoro / Design _____
N° pz. / N° pcs. _____

PD

Decoro / Design _____
N° pz. / N° pcs. _____

DECORAZIONE / DESIGN



- Scegli i decori Laserfer
Choose a Laserfer design

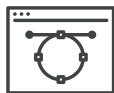

- Allega il tuo file .dxf
Send us your .dxf file



- Allega il tuo disegno
Send us your sketch

SPESSORI - MATERIALI E FINITURE / THICKNESS - MATERIALS AND FINISHING

Spessore Lamiera
Sheet Thickness

- 20/10
 25/10
 30/10
 40/10

Materiale / Material
Finitura / Finishing

- FERRO GREZZO / RAW IRON
 PRE-ZINCATO / GALVANIZED
 PRE-ZINCATO VERNICIATO
PRE-GALVANIZED POWDER COATED

- COR-TEN
 INOX 304
 INOX 316



RAL.....

For specific questions regarding finish, colouring, or technical topics, please contact your local sales office.

La fattibilità della realizzazione del decoro va verificata in base a dimensioni e spessori della lastra. / The feasibility of making certain decorations may depend on plate size and thickness.

Tutte le parti di questo catalogo - foto comprese - sono di proprietà Euro-Fer. La riproduzione, anche parziale, è vietata in ogni forma e con ogni mezzo. / Every part of this catalogue - photos included - is Euro-Fer's property. All forms of copying are strictly prohibited.

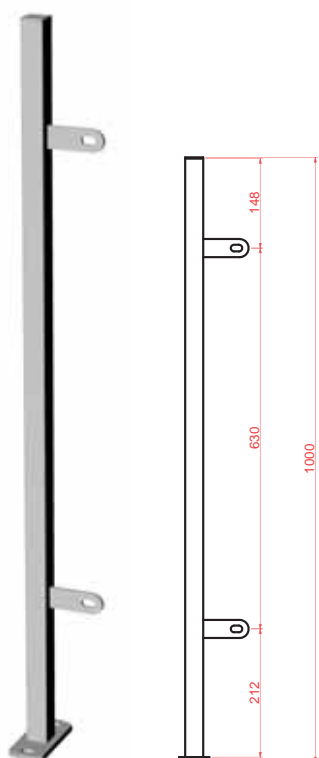

PLP 10 - H 1000 mm

Caposaldo forato con piastra di fissaggio. Comprende 2 viti M10 con dado antifurto.
/ *Drilled newel post with base plates to bolt down to concrete or walls. Includes 2 x M10 Bolts and snap off cone nuts to fix the panel to the post.*

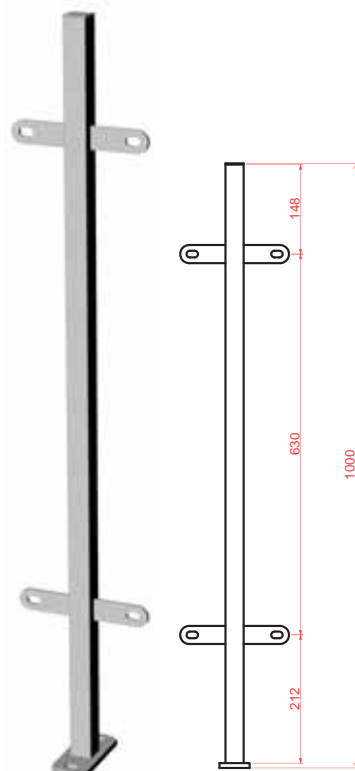

PLM 10 - H 1000 mm

Caposaldo forato con piastra di fissaggio. Comprende 4 viti M10 con dado antifurto.
/ *Drilled newel post with base plates to bolt down to concrete or walls. Includes 4 x M10 Bolts and snap off cone nuts to fix the panel to the post.*

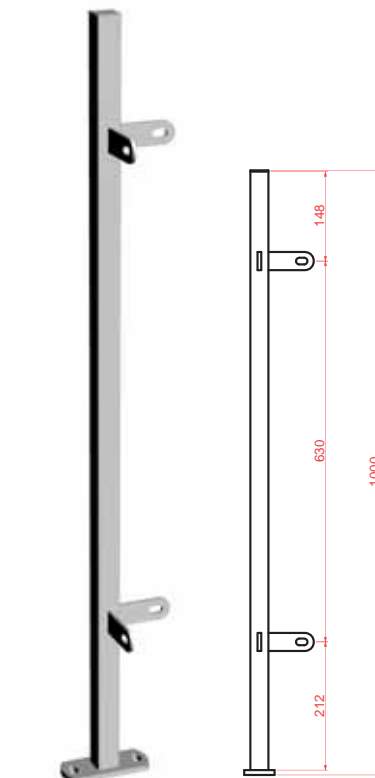

PLC 10 - H 1000 mm

Caposaldo forato con piastra di fissaggio. Comprende 4 viti M10 con dado antifurto.
/ *Drilled newel post with base plates to bolt down to concrete or walls. Includes 4 x M10 Bolts and snap off cone nuts to fix the panel to the post.*

Finiture / Finishes

Standard: piantone zincato a caldo / *galvanized post*

V: piantone zincato a caldo e verniciato / *galvanized and powder coated post*

G: piantone grezzo / *untreated post*



KIT-VITI.L
Comprende 4 viti M 10 in ferro zincato con dado antifurto.
Includes 4 x M 10 bolts (galvanized iron) and snap-off cone nuts.

I caposaldi della famiglia Laserfer sono zincati a caldo e vengono forniti con un set di viti M10 (KIT-VITI.L) zincate a freddo complete di dado antifurto per il fissaggio del pannello.
The Laserfer PANELS posts are hot galvanized, and include a set of M10 bolts (KIT-VITI.L) cold galvanized and snap-off cone nuts for fixing the panel.

LINEE LASERFER LINES

La fattibilità della realizzazione del decoro va verificata in base a dimensioni e spessori della lastra. / The feasibility of making certain decorations may depend on plate size and thickness.

Tutte le parti di questo catalogo - foto comprese - sono di proprietà Euro-Fer. La riproduzione, anche parziale, è vietata in ogni forma e con ogni mezzo. / Every part of this catalogue - photos included - is Euro-Fer's property . All forms of copying are strictly prohibited.

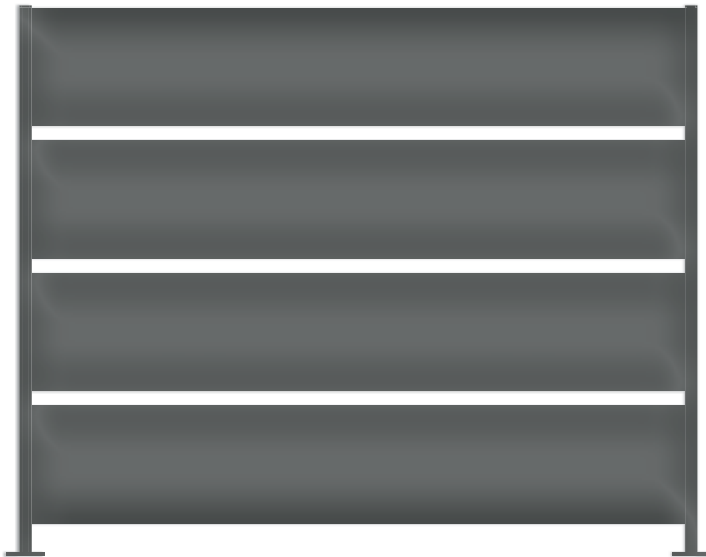
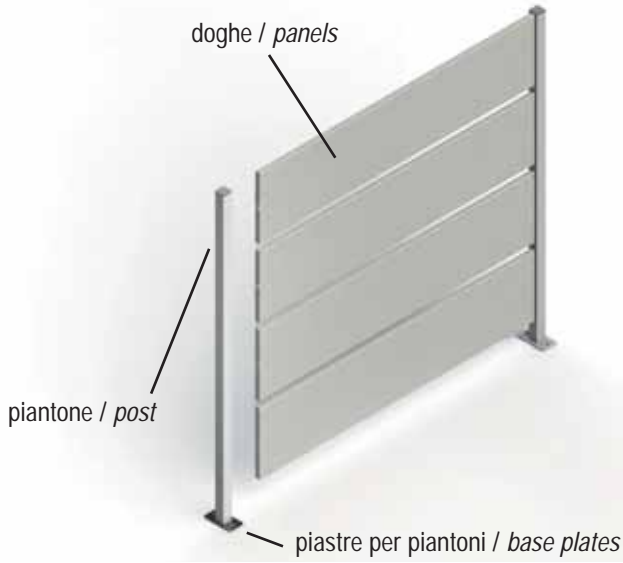

ART. SCR 01

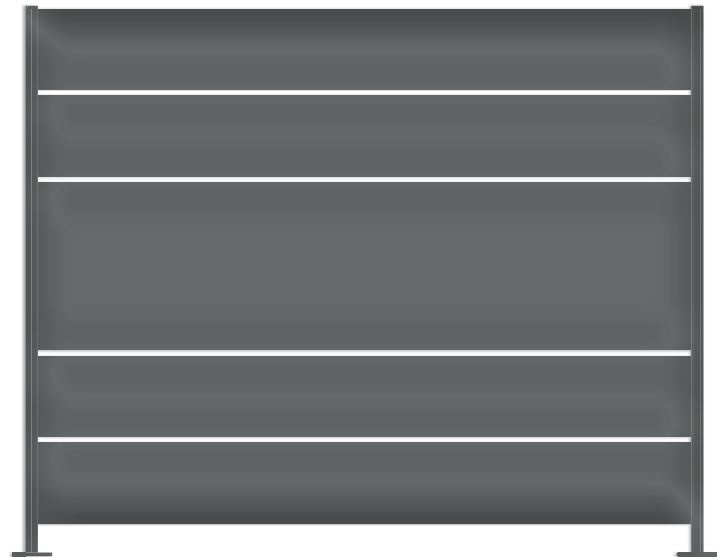

ART. SCR 02

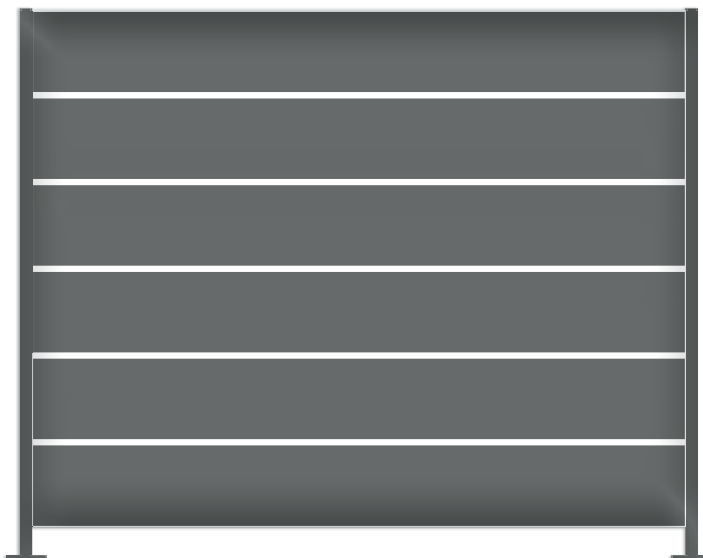

ART. SCR 03

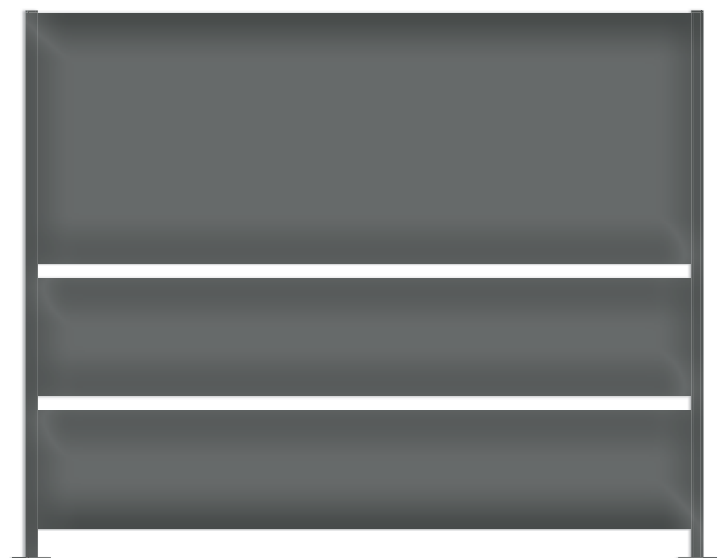

ART. SCR 04

La fattibilità della realizzazione del decoro va verificata in base a dimensioni e spessori della lastra. / The feasibility of making certain decorations may depend on plate size and thickness.
 Tutte le parti di questo catalogo - foto comprese - sono di proprietà Euro-Fer. La riproduzione, anche parziale, è vietata in ogni forma e con ogni mezzo. / Every part of this catalogue - photos included - is Euro-Fer's property. All forms of copying are strictly prohibited.



ART. PAR 01



ART. PAR 02

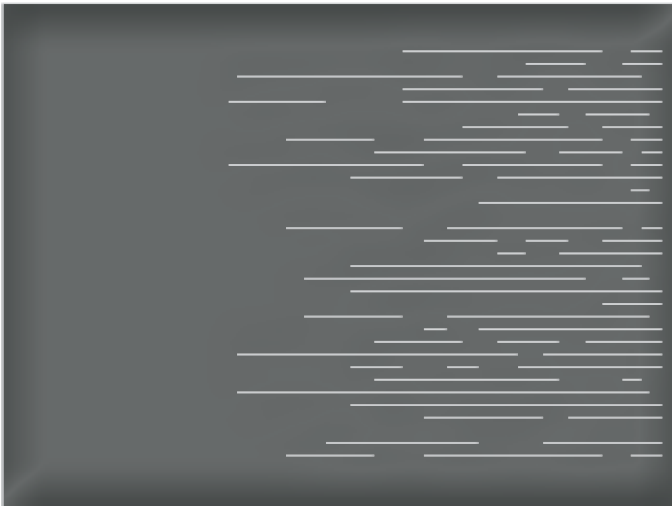

ART. PAR 03

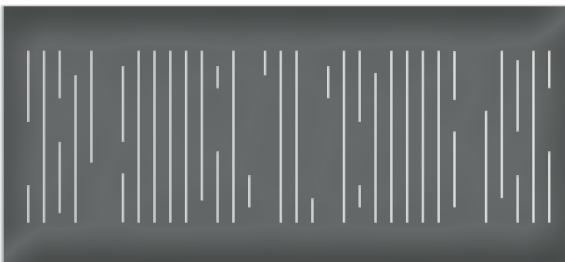

ART. PAR 06

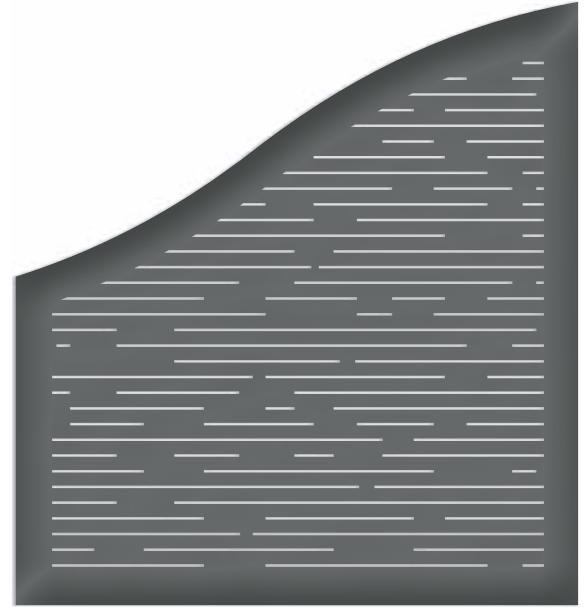

ART. PAR 04

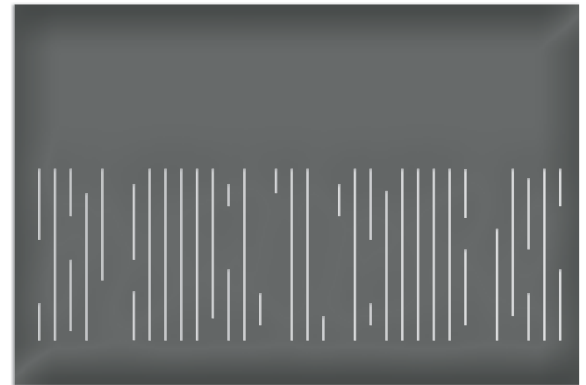

ART. PAR 05



La fattibilità della realizzazione del decoro va verificata in base a dimensioni e spessori della lastra. / The feasibility of making certain decorations may depend on plate size and thickness.

Tutte le parti di questo catalogo - foto comprese - sono di proprietà Euro-Fer. La riproduzione, anche parziale, è vietata in ogni forma e con ogni mezzo. / Every part of this catalogue - photos included - is Euro-Fer's property. All forms of copying are strictly prohibited.



ART. PAR 07



ART. PAR 09

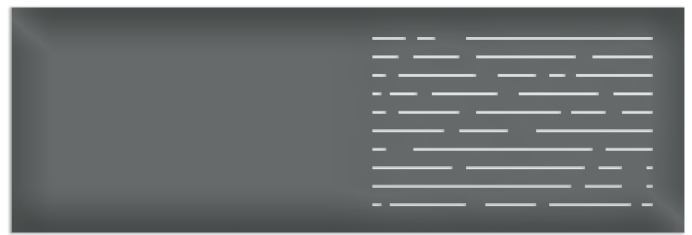

ART. PAR 12



ART. PAR 10



ART. PAR 13



ART. PAR 11

La fattibilità della realizzazione del decoro va verificata in base a dimensioni e spessori della lastra. / The feasibility of making certain decorations may depend on plate size and thickness.

Tutte le parti di questo catalogo - foto comprese - sono di proprietà Euro-Fer. La riproduzione, anche parziale, è vietata in ogni forma e con ogni mezzo. / Every part of this catalogue - photos included - is Euro-Fer's property. All forms of copying are strictly prohibited.

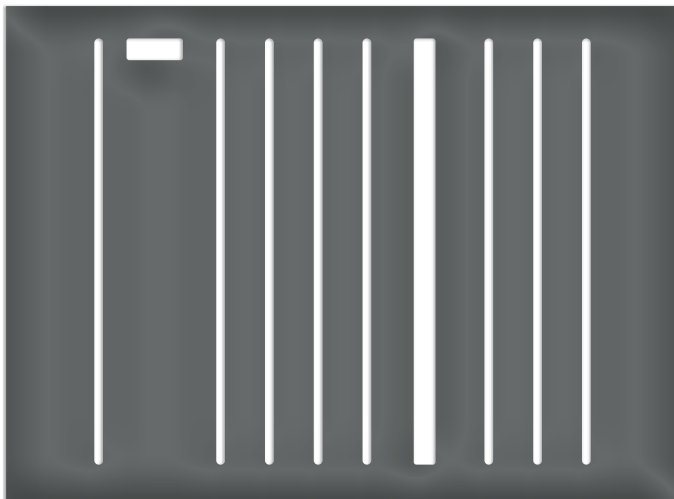

ART. PAR 14



ART. PAR 15

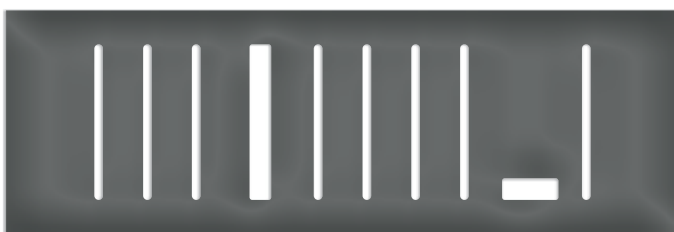

ART. PAR 16

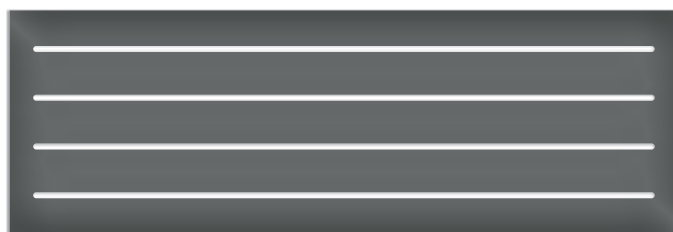

ART. PAR 17

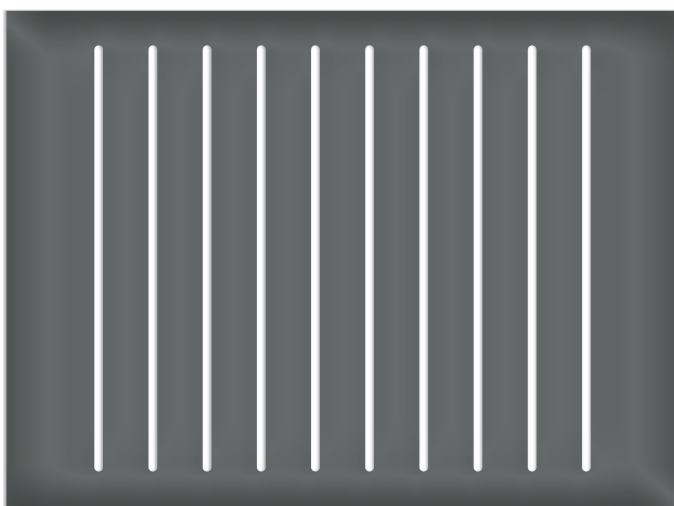

ART. PAR 18

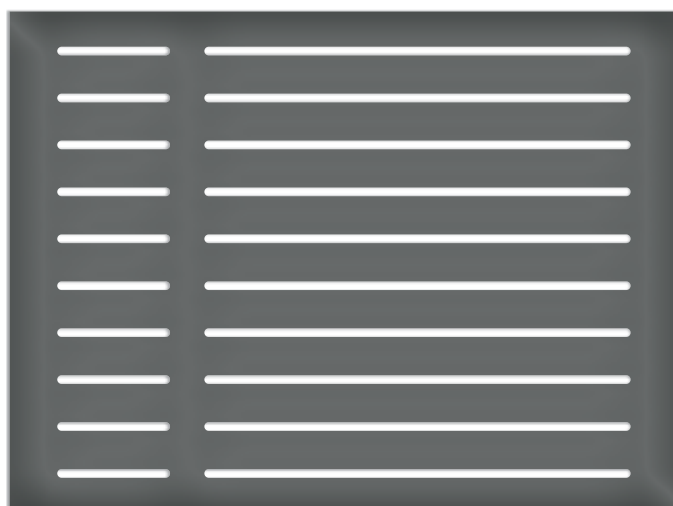

ART. PAR 19

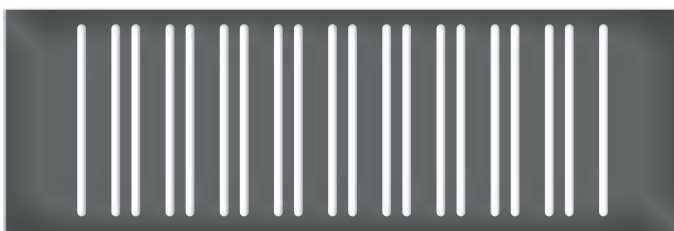

ART. PAR 20

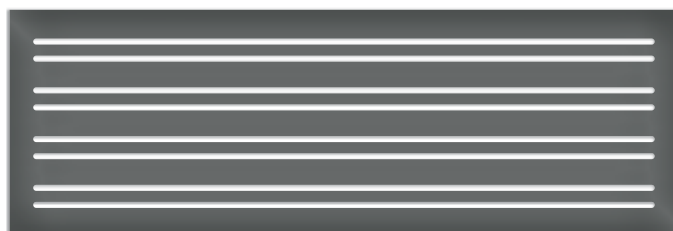

ART. PAR 21

La fattibilità della realizzazione del decoro va verificata in base a dimensioni e spessori della lastra. / The feasibility of making certain decorations may depend on plate size and thickness.

Tutte le parti di questo catalogo - foto comprese - sono di proprietà Euro-Fer. La riproduzione, anche parziale, è vietata in ogni forma e con ogni mezzo. / Every part of this catalogue - photos included - is Euro-Fer's property. All forms of copying are strictly prohibited.

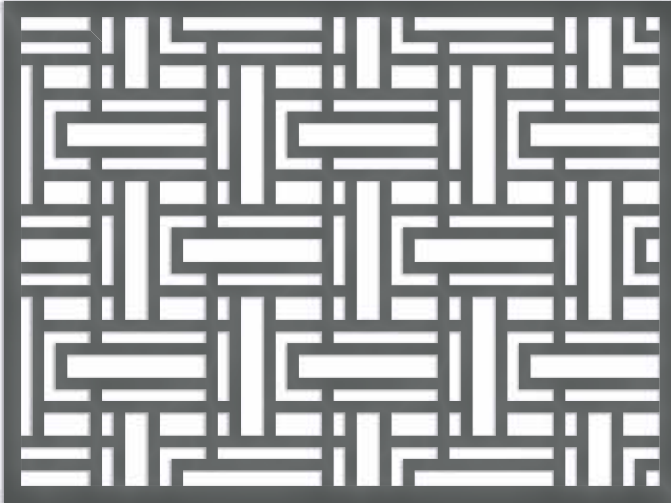

ART. GEO 01

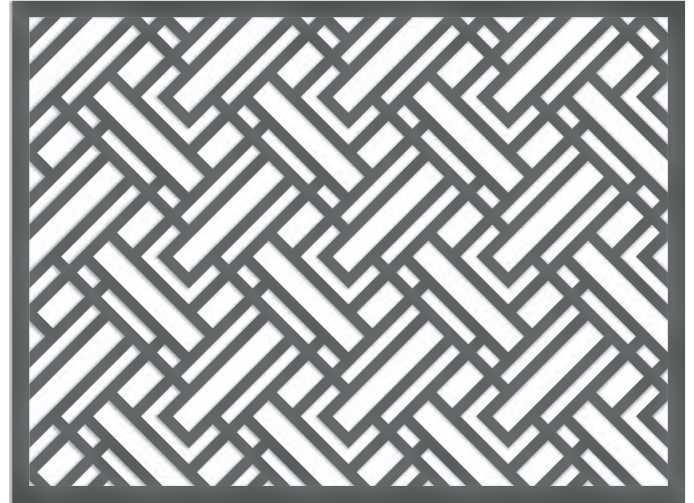

ART. GEO 02

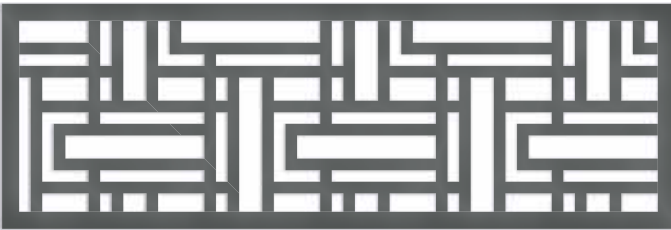

ART. GEO 03

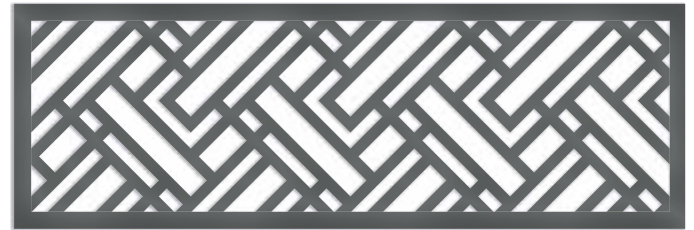

ART. GEO 04

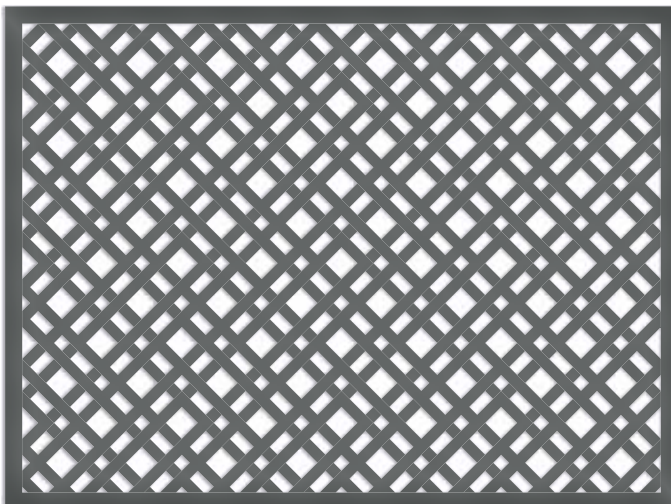

ART. GEO 05

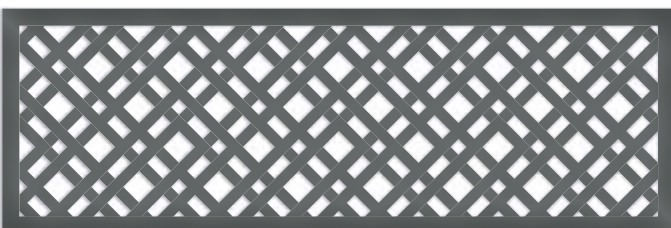

ART. GEO 06



La fattibilità della realizzazione del decoro va verificata in base a dimensioni e spessori della lastra. / The feasibility of making certain decorations may depend on plate size and thickness.
Tutte le parti di questo catalogo - foto comprese - sono di proprietà Euro-Fer. La riproduzione, anche parziale, è vietata in ogni forma e con ogni mezzo. / Every part of this catalogue - photos included - is Euro-Fer's property. All forms of copying are strictly prohibited.

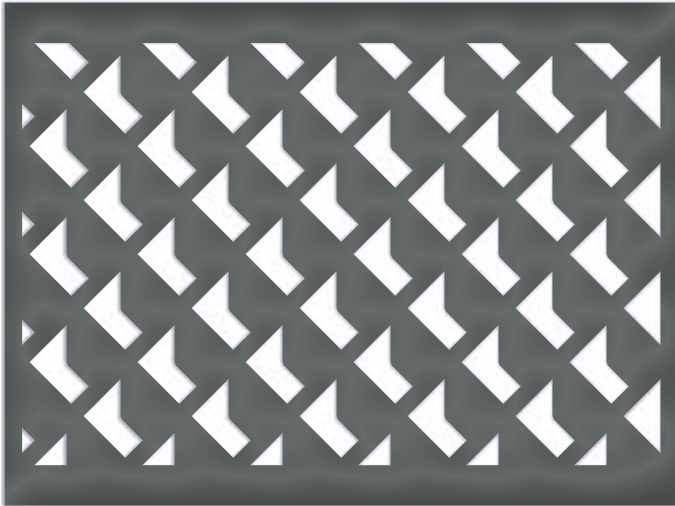

ART. QUA 05

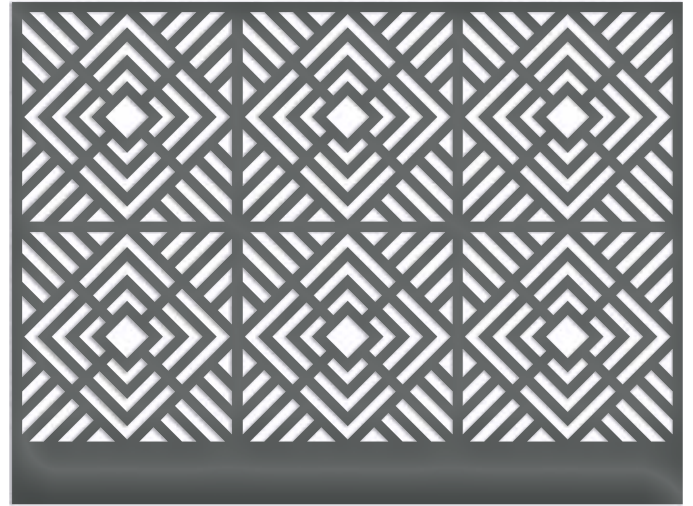

NEW

ART. QUA 07

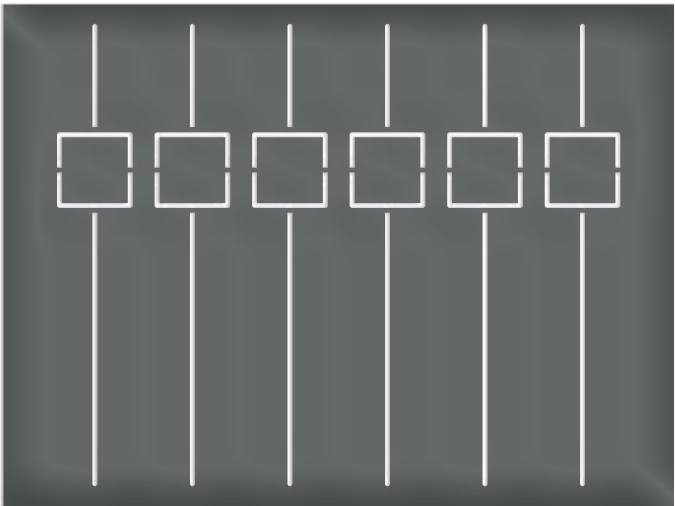

NEW

ART. QUA 08

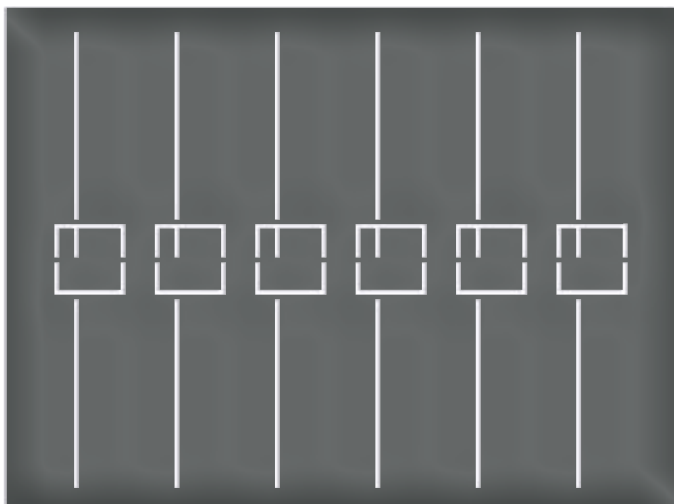

NEW

ART. QUA 09

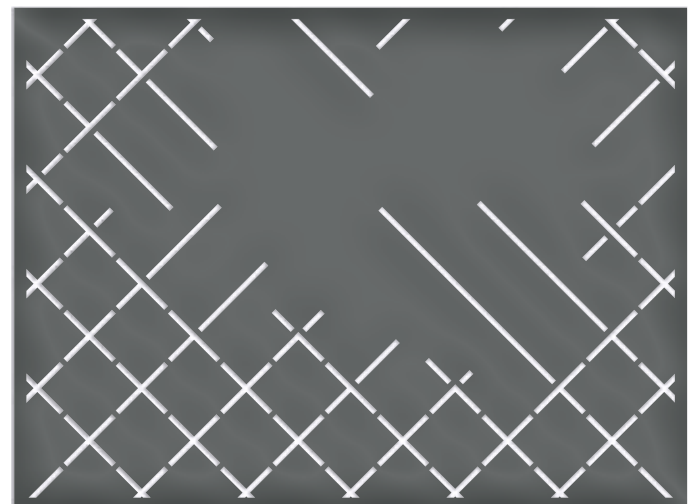

NEW

ART. QUA 10

La fattibilità della realizzazione del decoro va verificata in base a dimensioni e spessori della lastra. / The feasibility of making certain decorations may depend on plate size and thickness.

Tutte le parti di questo catalogo - foto comprese - sono di proprietà Euro-Fer. La riproduzione, anche parziale, è vietata in ogni forma e con ogni mezzo. / Every part of this catalogue - photos included - is Euro-Fer's property. All forms of copying are strictly prohibited.

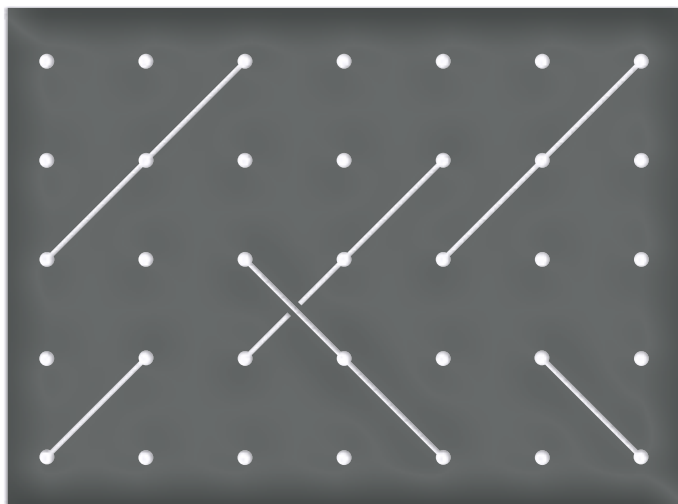

ART. SAR 01

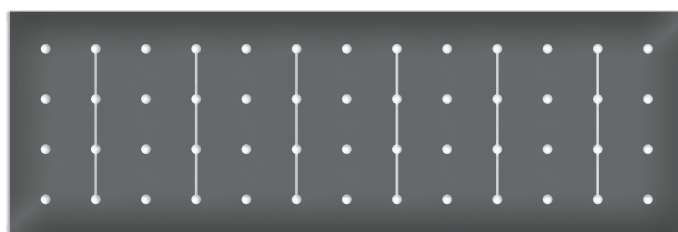

ART. SAR 06



LINEA SIDUS LINE



ART. SID 05

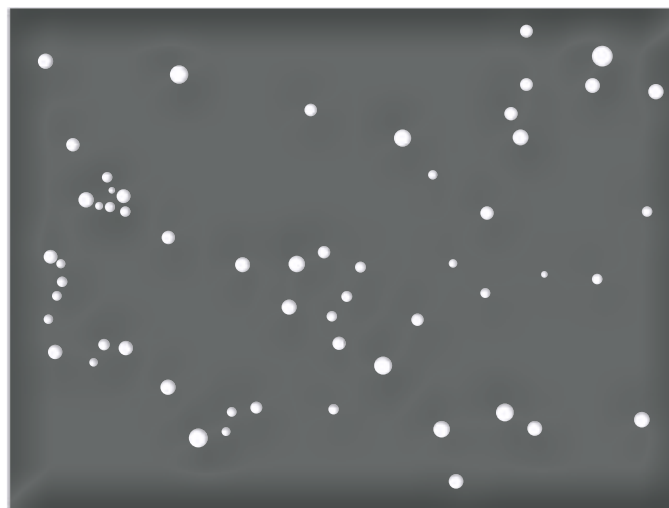

ART. SID 13

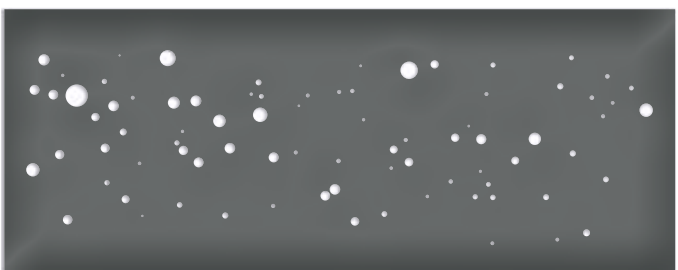

ART. SID 08

La fattibilità della realizzazione del decoro va verificata in base a dimensioni e spessori della lastra. / The feasibility of making certain decorations may depend on plate size and thickness.
Tutte le parti di questo catalogo - foto comprese - sono di proprietà Euro-Fer. La riproduzione, anche parziale, è vietata in ogni forma e con ogni mezzo. / Every part of this catalogue - photos included - is Euro-Fer's property. All forms of copying are strictly prohibited.

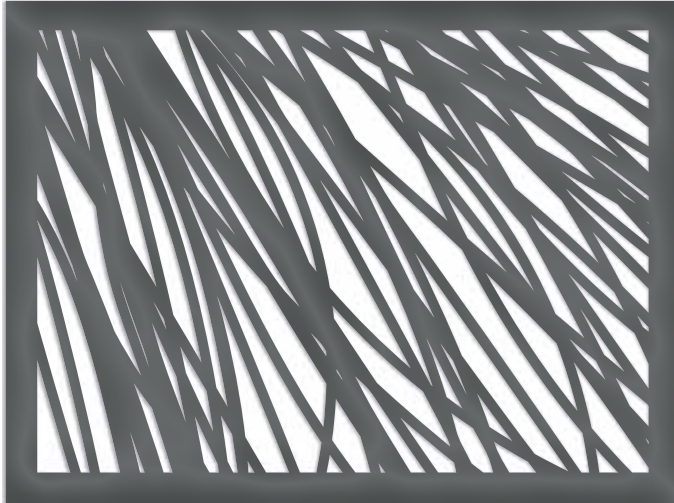

ART. RAM 01



ART. RAM 02

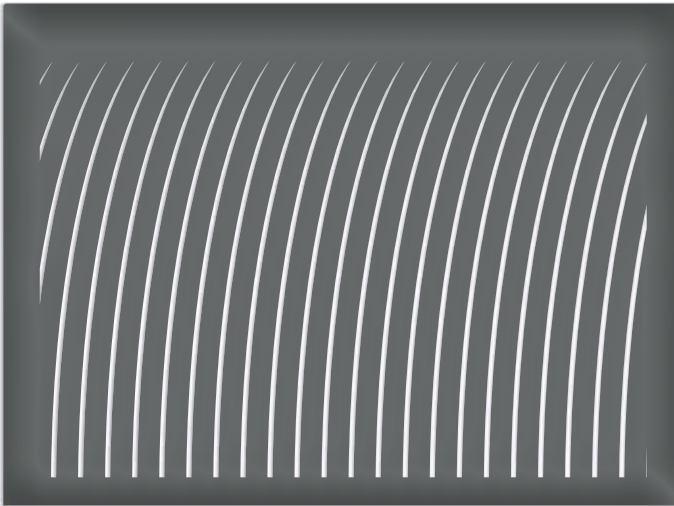

ART. RAM 03

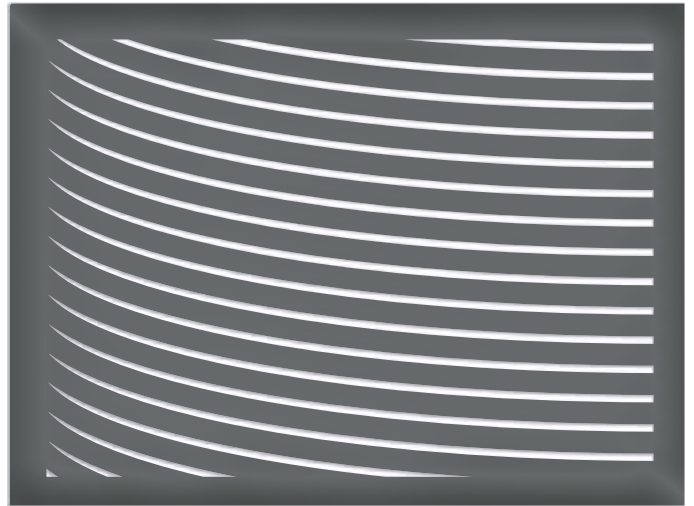

ART. RAM 04

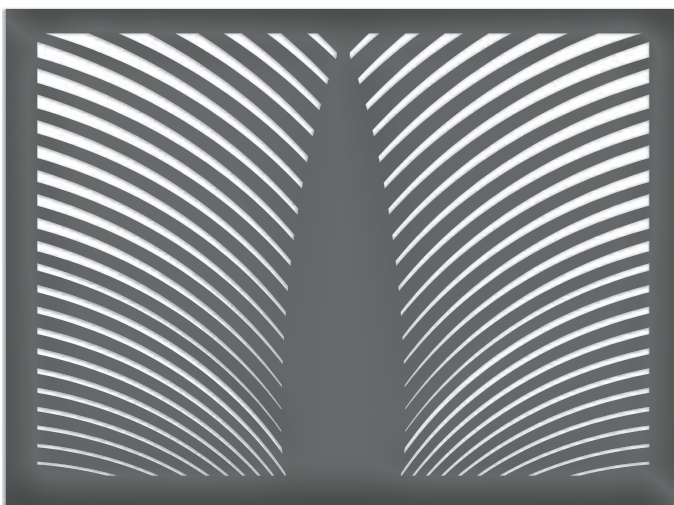

ART. RAM 05

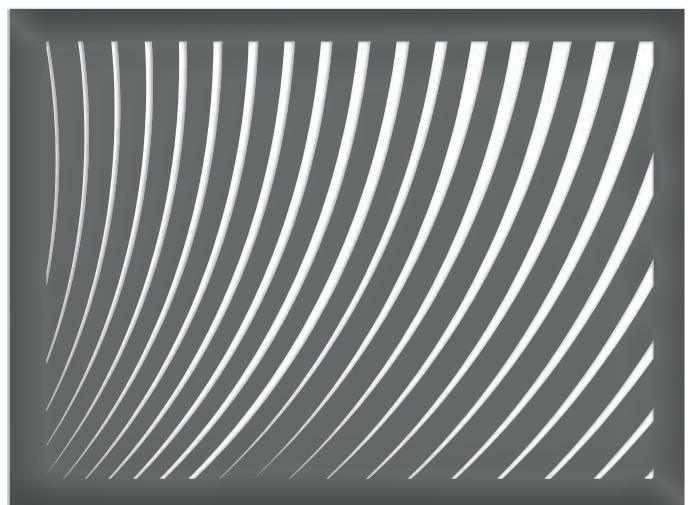

ART. RAM 06

La fattibilità della realizzazione del decoro va verificata in base a dimensioni e spessori della lastra. / The feasibility of making certain decorations may depend on plate size and thickness.

Tutte le parti di questo catalogo - foto comprese - sono di proprietà Euro-Fer. La riproduzione, anche parziale, è vietata in ogni forma e con ogni mezzo. / Every part of this catalogue - photos included - is Euro-Fer's property. All forms of copying are strictly prohibited.



La fattibilità della realizzazione del decoro va verificata in base a dimensioni e spessori della lastra. / The feasibility of making certain decorations may depend on plate size and thickness.
Tutte le parti di questo catalogo - foto comprese - sono di proprietà Euro-Fer. La riproduzione, anche parziale, è vietata in ogni forma e con ogni mezzo. / Every part of this catalogue - photos included - is Euro-Fer's property. All forms of copying are strictly prohibited.

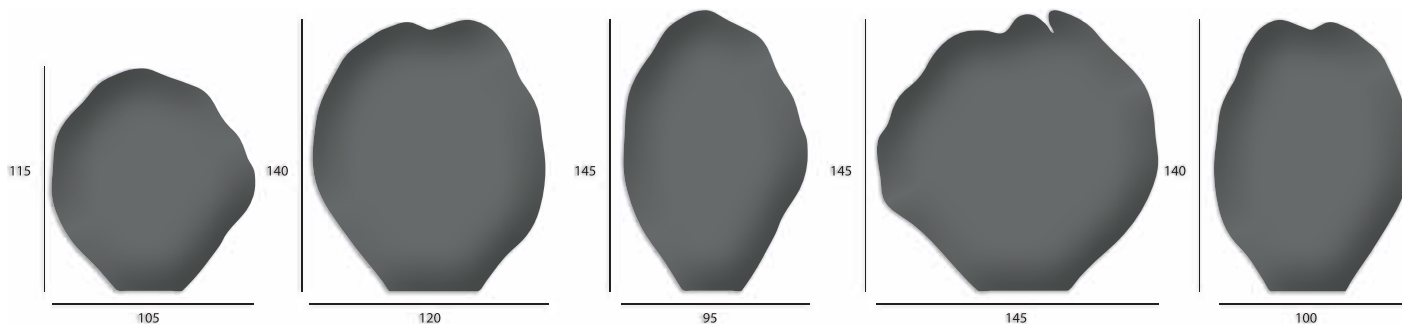

ART. PET 01

ART. PET 02

ART. PET 03

ART. PET 04

ART. PET 05

Petalis è un sistema modulare che può essere impiegato per dividere gli spazi, per creare zone indoor e outdoor, come parti di recinzioni, balaustre. I petali si possono utilizzare sovrapposti, accostati o intervallati da altri elementi del catalogo Eurofer.

Petalis is a modular system that can be used to divide spaces, to create indoor and outdoor areas, such as parts of fences, balustrades. The petals can be used superimposed, juxtaposed or interspersed with other elements of the Eurofer catalog.



La fattibilità della realizzazione del decoro va verificata in base a dimensioni e spessori della lastra. / The feasibility of making certain decorations may depend on plate size and thickness.

Tutte le parti di questo catalogo - foto comprese - sono di proprietà Euro-Fer. La riproduzione, anche parziale, è vietata in ogni forma e con ogni mezzo. / Every part of this catalogue - photos included - is Euro-Fer's property. All forms of copying are strictly prohibited.





ART. PRO 01



ART. PRO 04

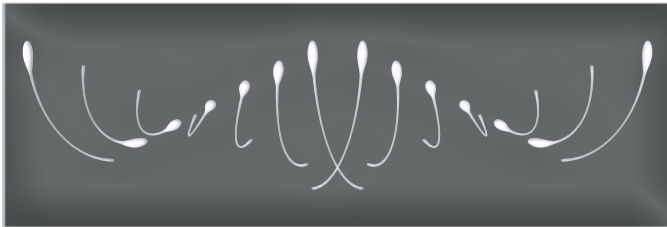

ART. PRO 02

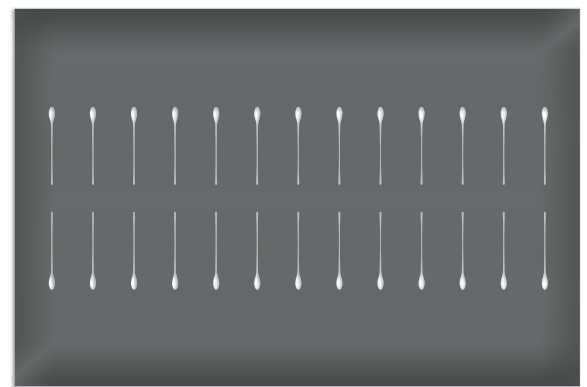

ART. PRO 05

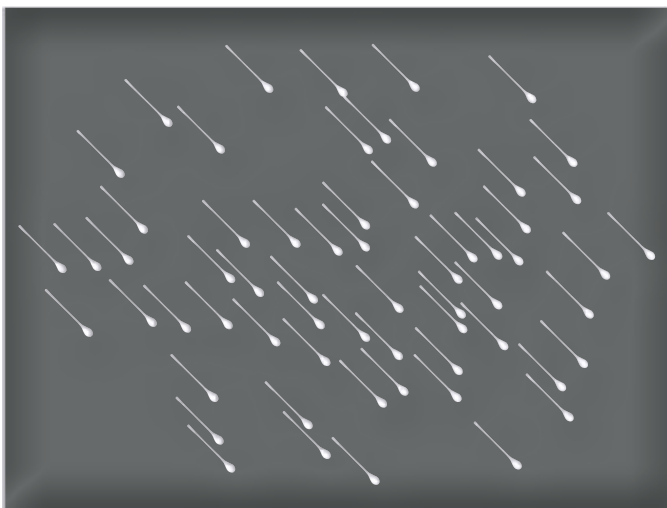

ART. PRO 03

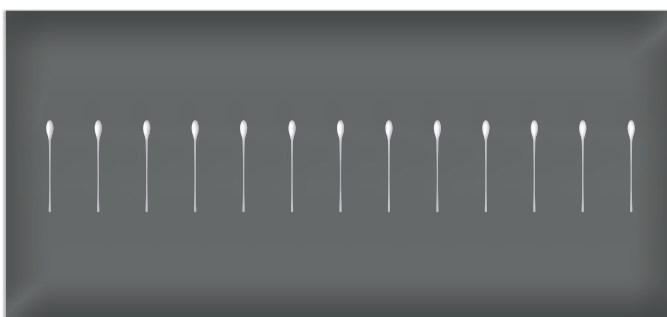

ART. PRO 06



La fattibilità della realizzazione del decoro va verificata in base a dimensioni e spessori della lastra. / The feasibility of making certain decorations may depend on plate size and thickness.

Tutte le parti di questo catalogo - foto comprese - sono di proprietà Euro-Fer. La riproduzione, anche parziale, è vietata in ogni forma e con ogni mezzo. / Every part of this catalogue - photos included - is Euro-Fer's property. All forms of copying are strictly prohibited.



ART. PRO 07

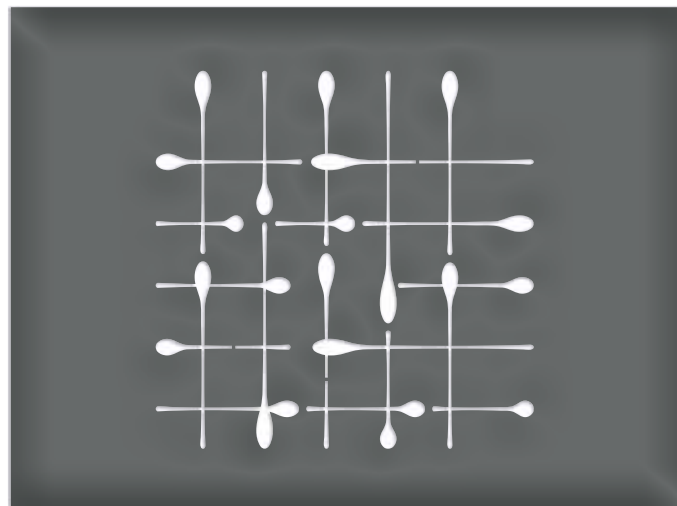

ART. PRO 11

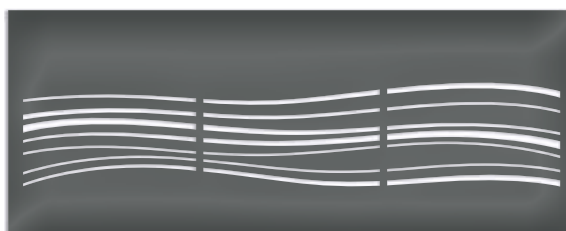

ART. PRO 08



ART. PRO 13

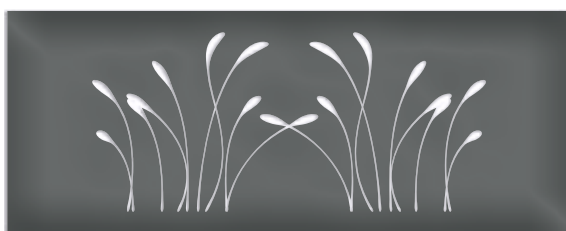

ART. PRO 10



La fattibilità della realizzazione del decoro va verificata in base a dimensioni e spessori della lastra. / The feasibility of making certain decorations may depend on plate size and thickness.
Tutte le parti di questo catalogo - foto comprese - sono di proprietà Euro-Fer. La riproduzione, anche parziale, è vietata in ogni forma e con ogni mezzo. / Every part of this catalogue - photos included - is Euro-Fer's property. All forms of copying are strictly prohibited.



ART. ROS 01



ART. ROS 02



ART. ROS 03

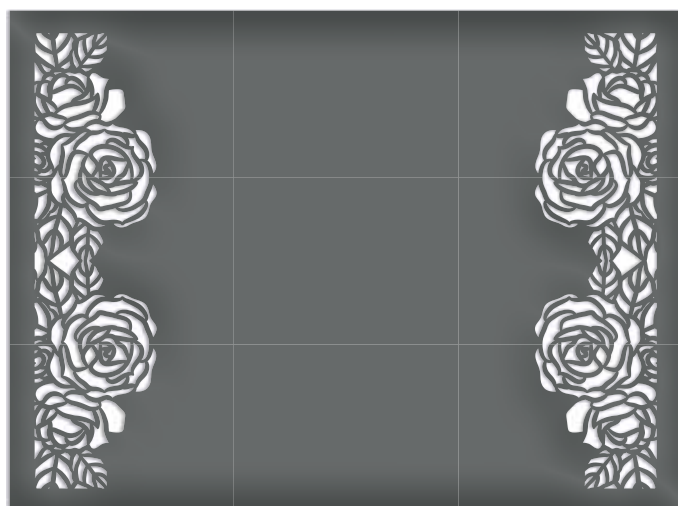

ART. ROS 04

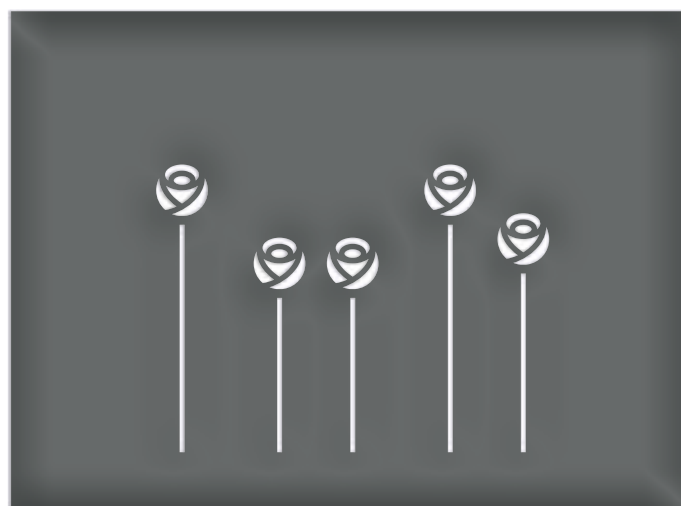

ART. ROS 05

La fattibilità della realizzazione del decoro va verificata in base a dimensioni e spessori della lastra. / The feasibility of making certain decorations may depend on plate size and thickness.

Tutte le parti di questo catalogo - foto comprese - sono di proprietà Euro-Fer. La riproduzione, anche parziale, è vietata in ogni forma e con ogni mezzo. / Every part of this catalogue - photos included - is Euro-Fer's property. All forms of copying are strictly prohibited.



ART. PHY 01



ART. PHY 02



ART. PHY 03



ART. PHY 04



La fattibilità della realizzazione del decoro va verificata in base a dimensioni e spessori della lastra. / The feasibility of making certain decorations may depend on plate size and thickness.
Tutte le parti di questo catalogo - foto comprese - sono di proprietà Euro-Fer. La riproduzione, anche parziale, è vietata in ogni forma e con ogni mezzo. / Every part of this catalogue - photos included - is Euro-Fer's property. All forms of copying are strictly prohibited.

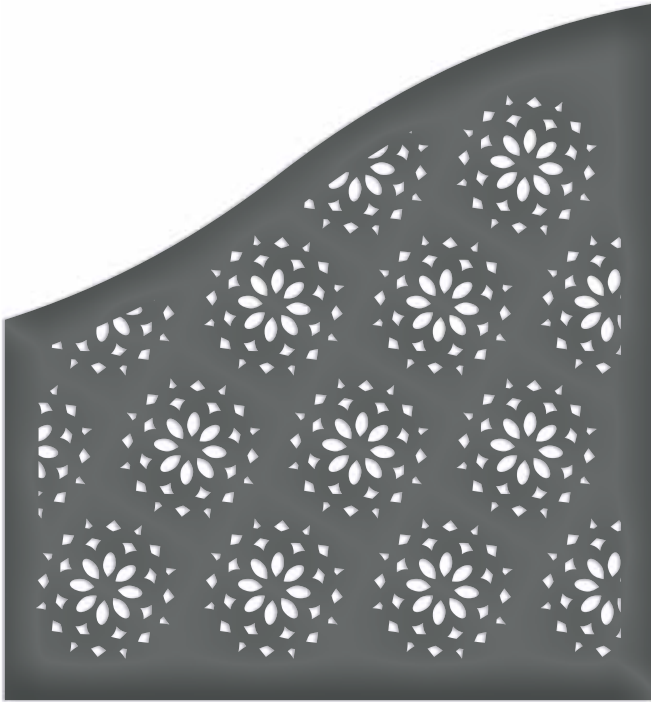

ART. AST 01



ART. AST 02

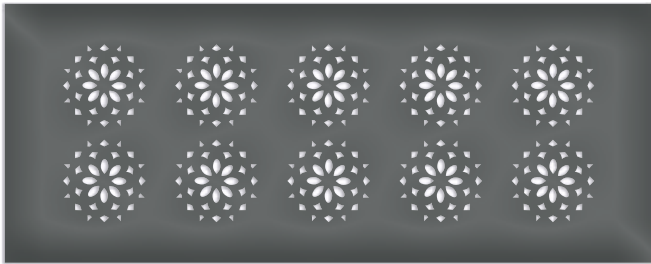

ART. AST 05

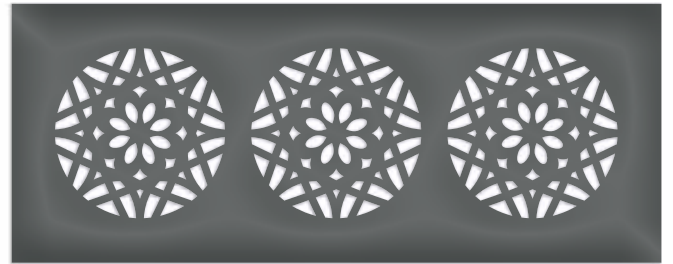

ART. AST 06



La fattibilità della realizzazione del decoro va verificata in base a dimensioni e spessori della lastra. / The feasibility of making certain decorations may depend on plate size and thickness.

Tutte le parti di questo catalogo - foto comprese - sono di proprietà Euro-Fer. La riproduzione, anche parziale, è vietata in ogni forma e con ogni mezzo. / Every part of this catalogue - photos included - is Euro-Fer's property. All forms of copying are strictly prohibited.

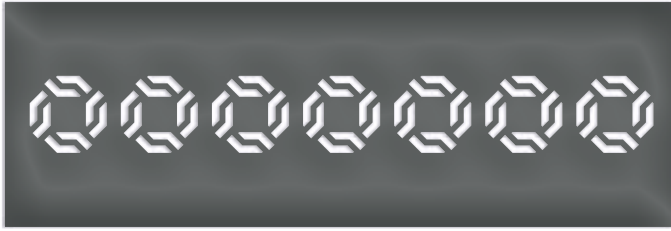

ART. OTT 02

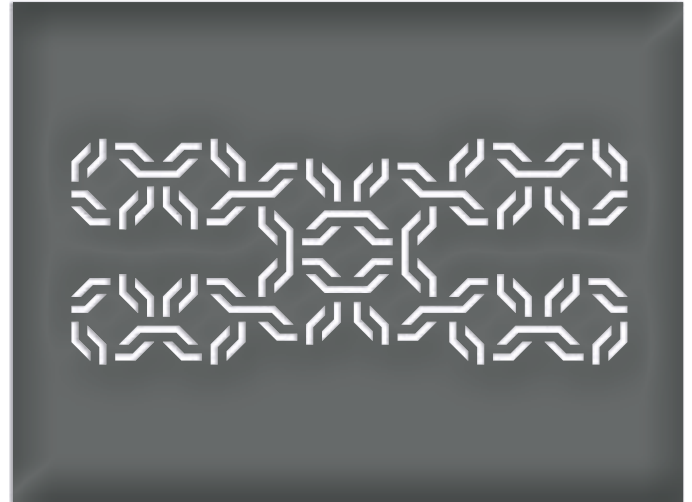

ART. OTT 03



ART. OTT 04



ART. OTT 07



ART. OTT 08

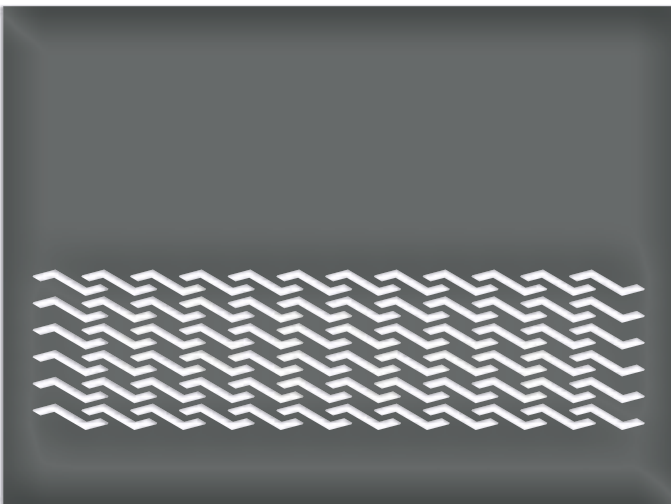

ART. OTT 11

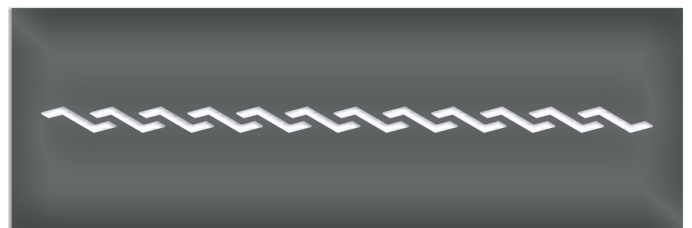

ART. OTT 12

La fattibilità della realizzazione del decoro va verificata in base a dimensioni e spessori della lastra. / The feasibility of making certain decorations may depend on plate size and thickness.
Tutte le parti di questo catalogo - foto comprese - sono di proprietà Euro-Fer. La riproduzione, anche parziale, è vietata in ogni forma e con ogni mezzo. / Every part of this catalogue - photos included - is Euro-Fer's property. All forms of copying are strictly prohibited.



ART. CAN 01



ART. CAN 04

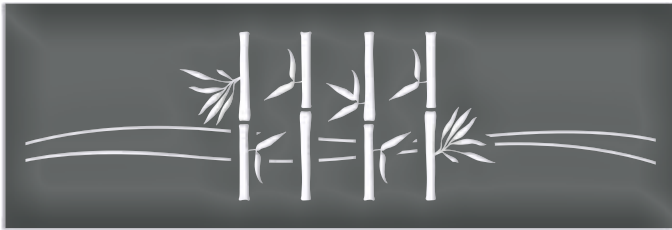

ART. CAN 02

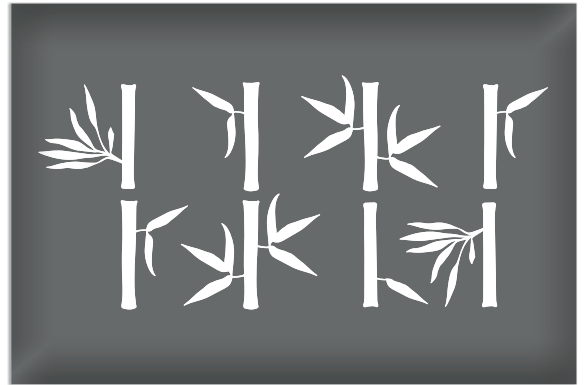

ART. CAN 05

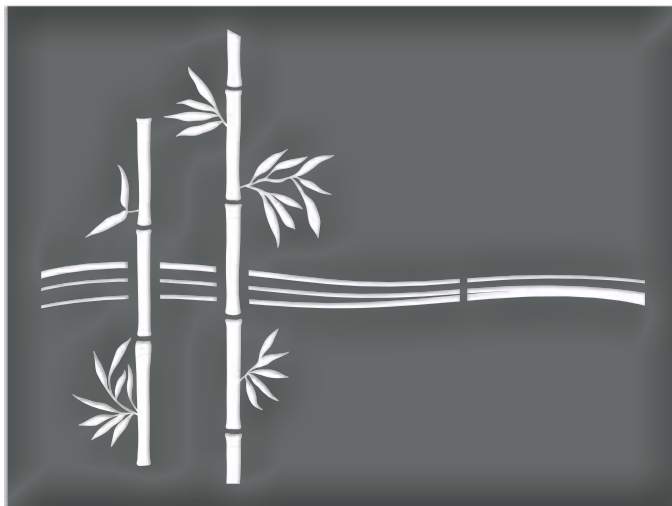

ART. CAN 03

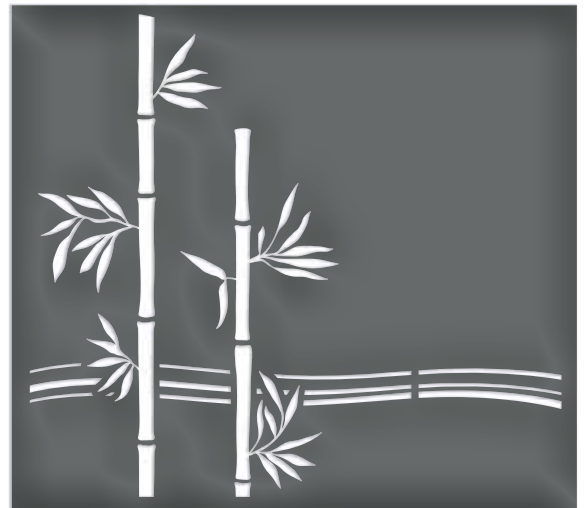

ART. CAN 07

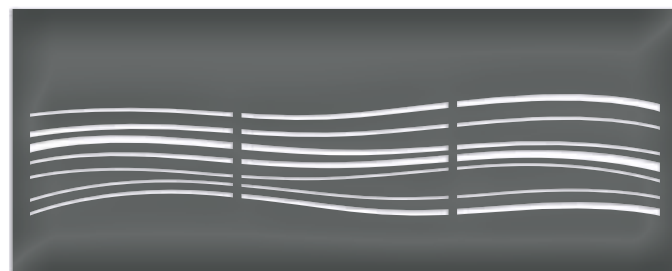

ART. CAN 08

La fattibilità della realizzazione del decoro va verificata in base a dimensioni e spessori della lastra. / The feasibility of making certain decorations may depend on plate size and thickness.

Tutte le parti di questo catalogo - foto comprese - sono di proprietà Euro-Fer. La riproduzione, anche parziale, è vietata in ogni forma e con ogni mezzo. / Every part of this catalogue - photos included - is Euro-Fer's property. All forms of copying are strictly prohibited.

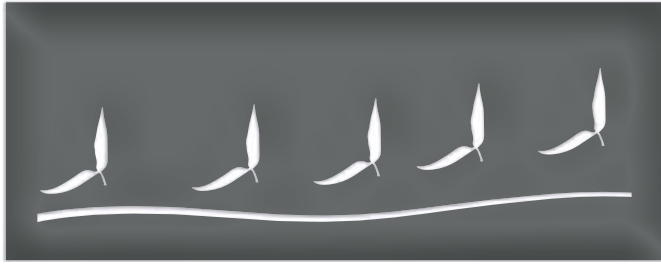

ART. CAN 09

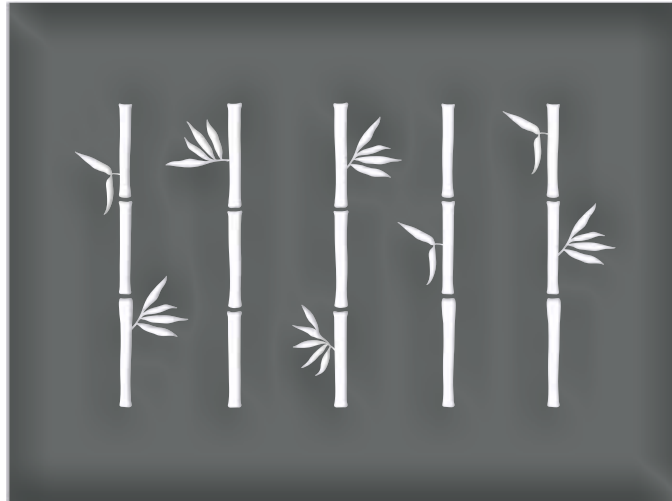

ART. CAN 11



ART. CAN 12



La fattibilità della realizzazione del decoro va verificata in base a dimensioni e spessori della lastra. / The feasibility of making certain decorations may depend on plate size and thickness.
Tutte le parti di questo catalogo - foto comprese - sono di proprietà Euro-Fer. La riproduzione, anche parziale, è vietata in ogni forma e con ogni mezzo. / Every part of this catalogue - photos included - is Euro-Fer's property. All forms of copying are strictly prohibited.

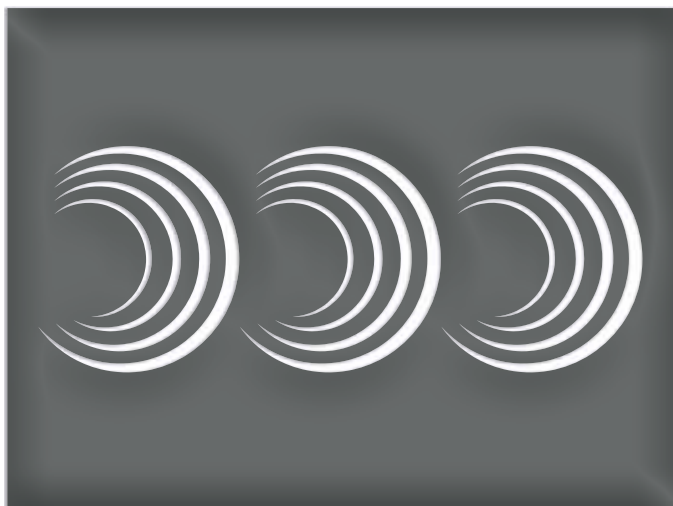

ART. SEC 01

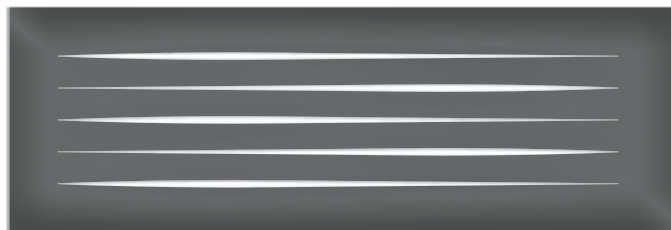

ART. SEC 02

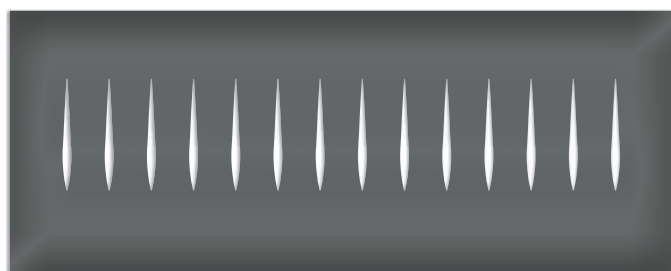

ART. SEC 08

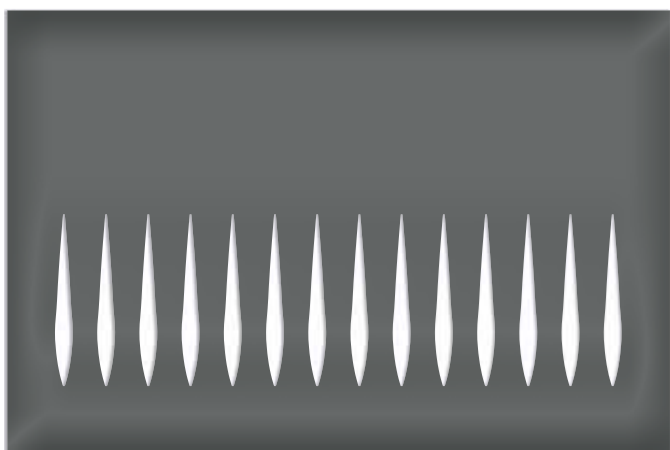

ART. SEC 05

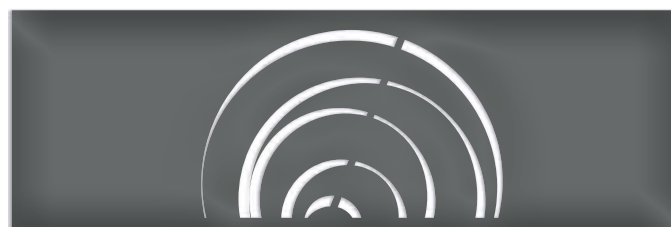

ART. SEC 12

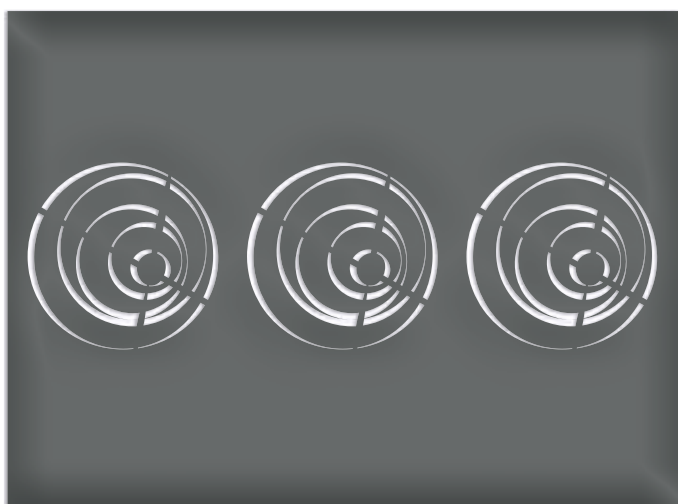

ART. SEC 11

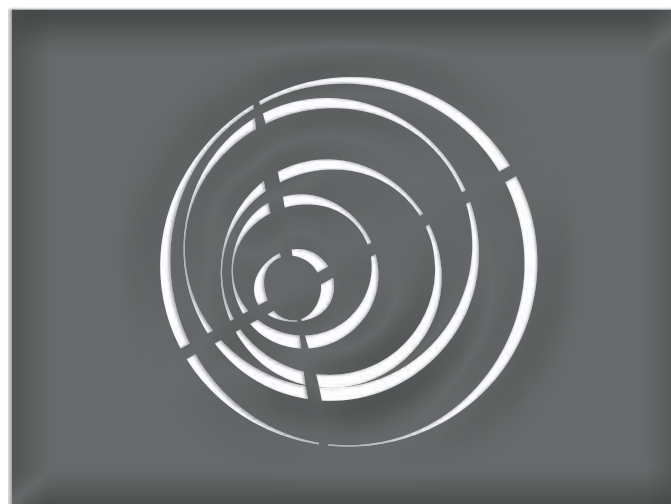

ART. SEC 13

La fattibilità della realizzazione del decoro va verificata in base a dimensioni e spessori della lastra. / The feasibility of making certain decorations may depend on plate size and thickness.

Tutte le parti di questo catalogo - foto comprese - sono di proprietà Euro-Fer. La riproduzione, anche parziale, è vietata in ogni forma e con ogni mezzo. / Every part of this catalogue - photos included - is Euro-Fer's property. All forms of copying are strictly prohibited.

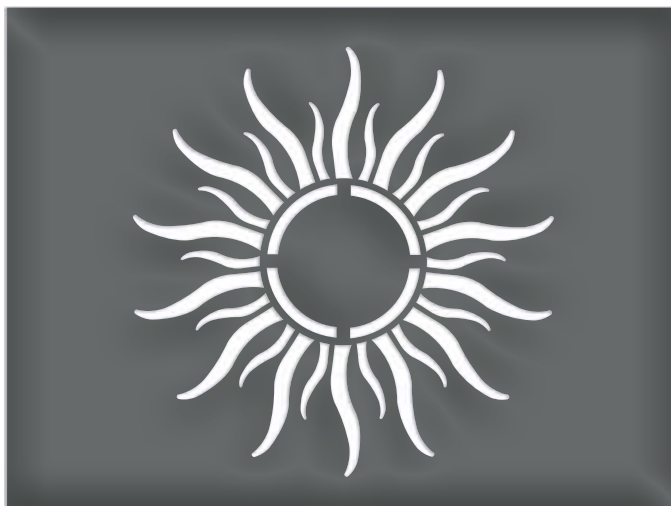

ART. SOL 01

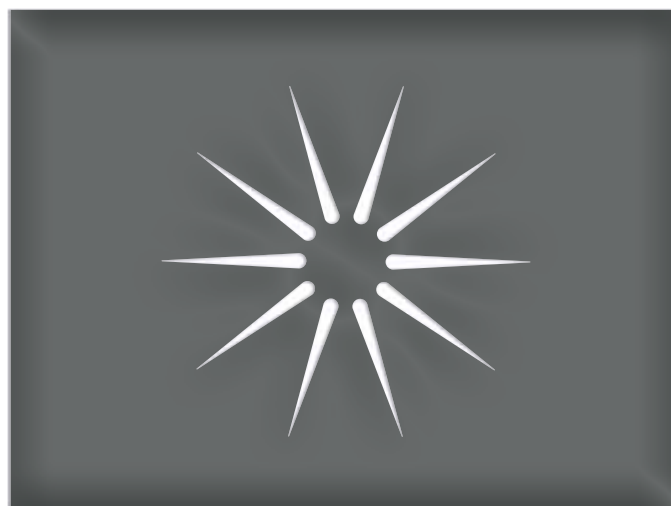

ART. SOL 02



ART. SOL 03



ART. SOL 04

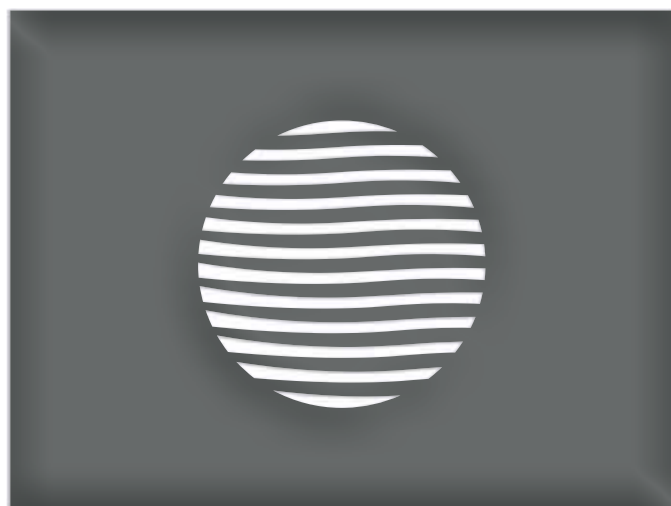

ART. SOL 05



ART. SOL 06

La fattibilità della realizzazione del decoro va verificata in base a dimensioni e spessori della lastra. / The feasibility of making certain decorations may depend on plate size and thickness.
Tutte le parti di questo catalogo - foto comprese - sono di proprietà Euro-Fer. La riproduzione, anche parziale, è vietata in ogni forma e con ogni mezzo. / Every part of this catalogue - photos included - is Euro-Fer's property. All forms of copying are strictly prohibited.

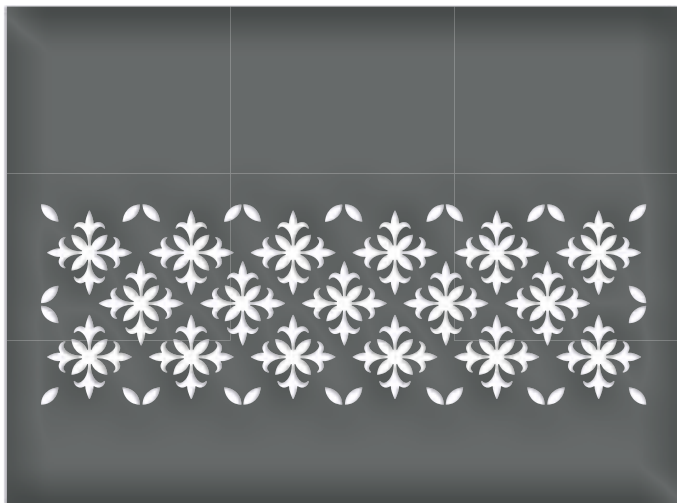

ART. ACA 01

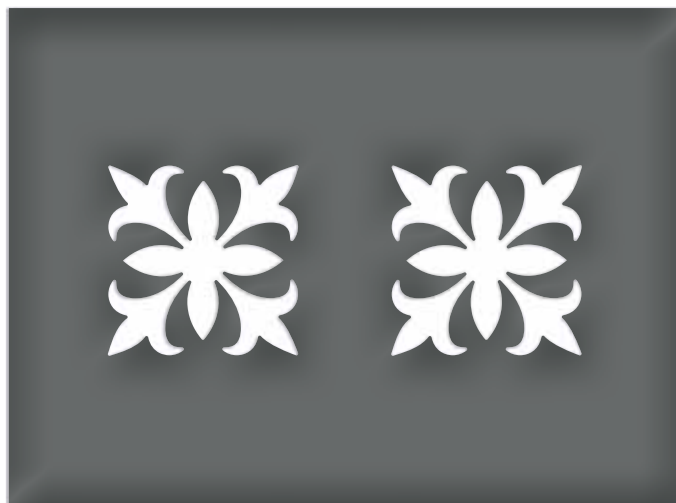

ART. ACA 02

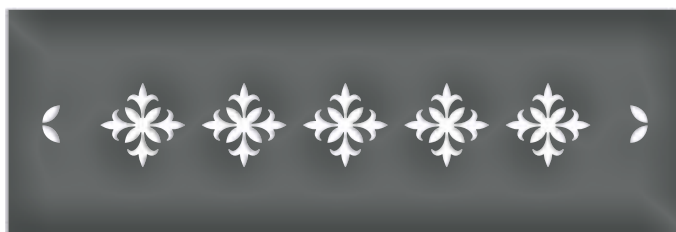

ART. ACA 03



ART. ACA 04



La fattibilità della realizzazione del decoro va verificata in base a dimensioni e spessori della lastra. / The feasibility of making certain decorations may depend on plate size and thickness.

Tutte le parti di questo catalogo - foto comprese - sono di proprietà Euro-Fer. La riproduzione, anche parziale, è vietata in ogni forma e con ogni mezzo. / Every part of this catalogue - photos included - is Euro-Fer's property. All forms of copying are strictly prohibited.



ART. CAT 01



ART. MIS 01



ART. MIS 02



ART. MIS 03

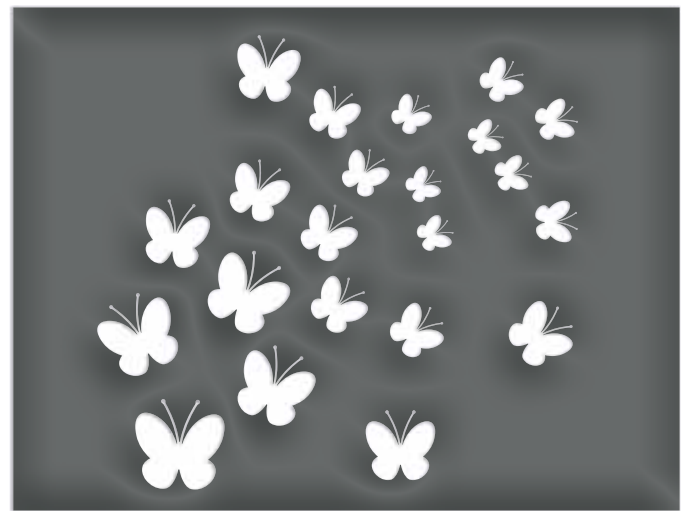

ART. MIS 05



ART. MIS 04

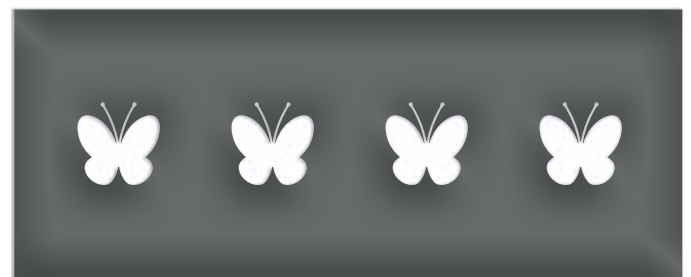

ART. MIS 06



ART. MIS 07

La fattibilità della realizzazione del decoro va verificata in base a dimensioni e spessori della lastra. / The feasibility of making certain decorations may depend on plate size and thickness.
Tutte le parti di questo catalogo - foto comprese - sono di proprietà Euro-Fer. La riproduzione, anche parziale, è vietata in ogni forma e con ogni mezzo. / Every part of this catalogue - photos included - is Euro-Fer's property. All forms of copying are strictly prohibited.

SPESSORE / THICKNESS mm 6 - 8

- 15 -



410x330 mm
LR001.60/10.FE
LR001.80/10.FE

- 12,5 -



410x330 mm
LR004.60/10.FE
LR004.80/10.FE

- 12,5 -



410x330 mm
LR005.60/10.FE
LR005.80/10.FE

- 12,5 -



410x330 mm
LR006.60/10.FE
LR006.80/10.FE

- 15 -



430x350 mm
LR007.60/10.FE
LR007.80/10.FE

- 15 -



430x350 mm
LR008.60/10.FE
LR008.80/10.FE

- 15 -



430x350 mm
LR009.60/10.FE
LR009.80/10.FE

- 15 -



430x350 mm
LR010.60/10.FE
LR010.80/10.FE

- 15 -



430x350 mm
LR011.60/10.FE
LR011.80/10.FE

- 15 -



430x350 mm
LR0110.60/10.FE
LR0110.80/10.FE

- 15 -



430x350 mm
LR0111.60/10.FE
LR0111.80/10.FE

La fattibilità della realizzazione del decoro va verificata in base a dimensioni e spessori della lastra. / The feasibility of making certain decorations may depend on plate size and thickness.

Tutte le parti di questo catalogo - foto comprese - sono di proprietà Euro-Fer. La riproduzione, anche parziale, è vietata in ogni forma e con ogni mezzo. / Every part of this catalogue - photos included - is Euro-Fer's property. All forms of copying are strictly prohibited.

- 12,5 -



290x160 mm
LR012.60/10.FE
LR012.80/10.FE

- 12,5 -



290x160 mm
LR013.60/10.FE
LR013.80/10.FE

- 12,5 -



290x160 mm
LR014.60/10.FE
LR014.80/10.FE

- 15 -



290x160 mm
LR015.60/10.FE
LR015.80/10.FE

- 15 -



290x160 mm
LR016.60/10.FE
LR016.80/10.FE



La fattibilità della realizzazione del decoro va verificata in base a dimensioni e spessori della lastra. / The feasibility of making certain decorations may depend on plate size and thickness.
Tutte le parti di questo catalogo - foto comprese - sono di proprietà Euro-Fer. La riproduzione, anche parziale, è vietata in ogni forma e con ogni mezzo. / Every part of this catalogue - photos included - is Euro-Fer's property. All forms of copying are strictly prohibited.

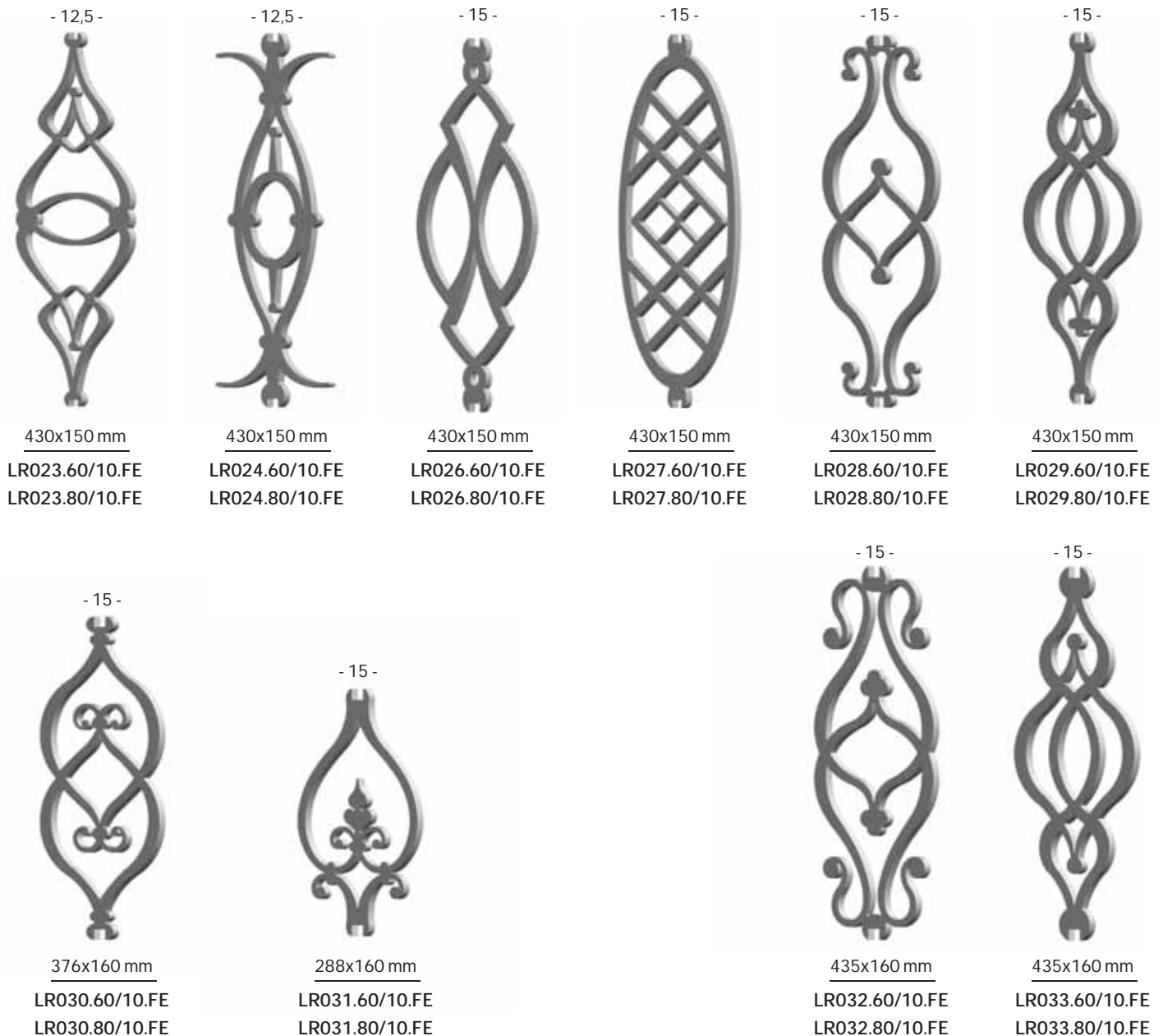

TERMINALI ferro grezzo / POST TOPS raw iron

SPESSORE / THICKNESS mm 6 - 8

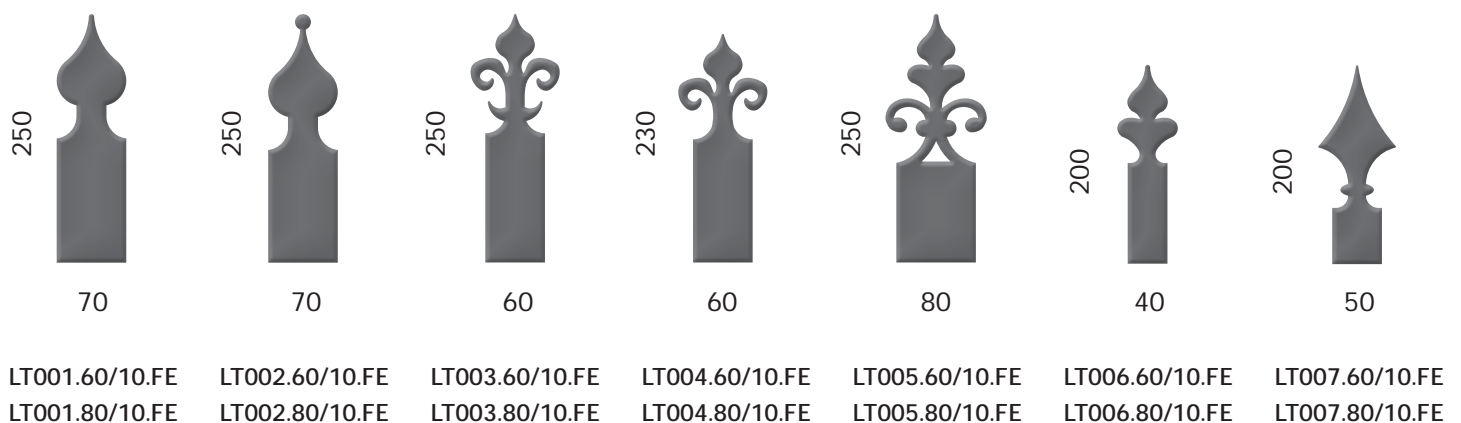

La fattibilità della realizzazione del decoro va verificata in base a dimensioni e spessori della lastra. / The feasibility of making certain decorations may depend on plate size and thickness.

Tutte le parti di questo catalogo - foto comprese - sono di proprietà Euro-Fer. La riproduzione, anche parziale, è vietata in ogni forma e con ogni mezzo. / Every part of this catalogue - photos included - is Euro-Fer's property. All forms of copying are strictly prohibited.

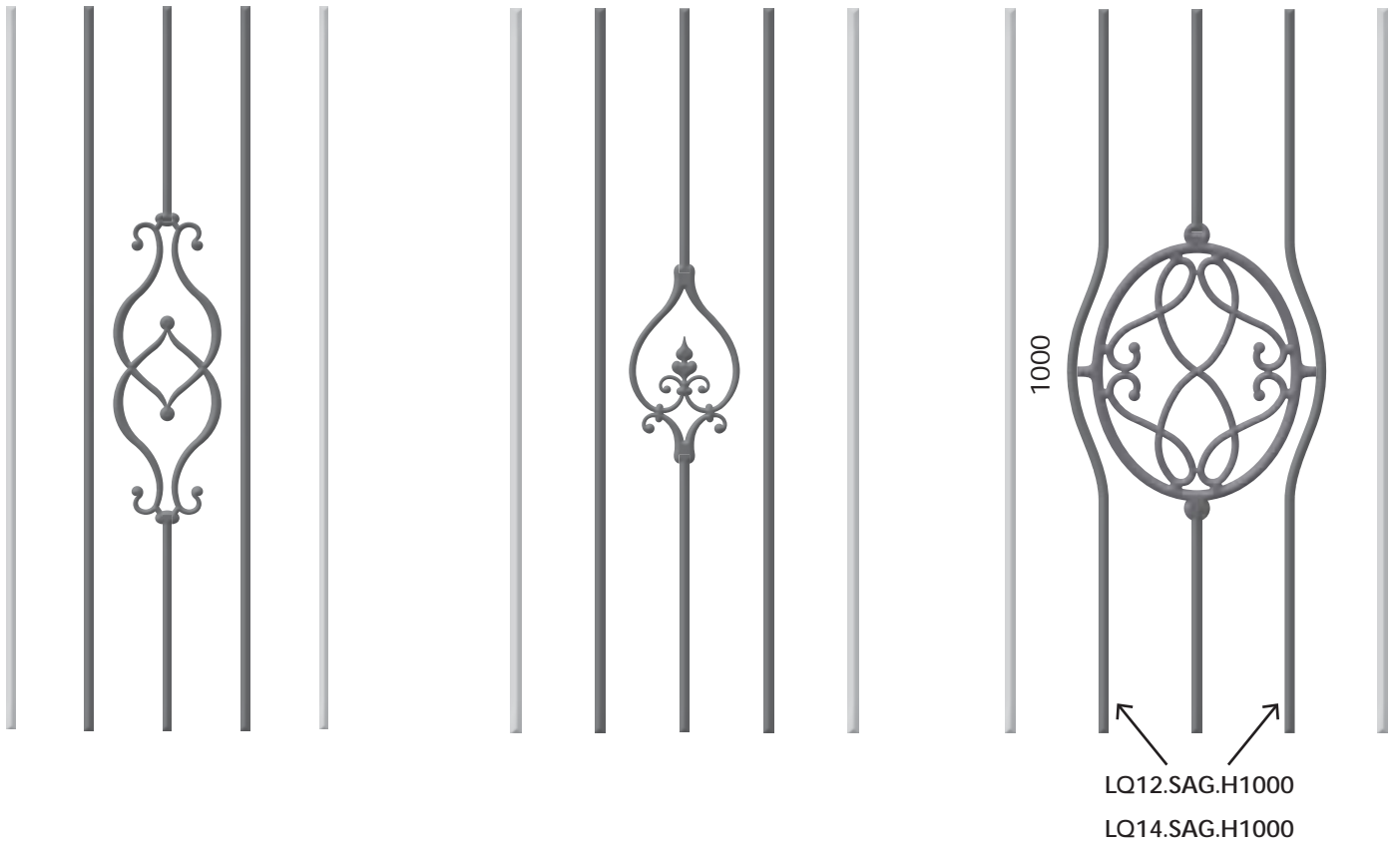

La fattibilità della realizzazione del decoro va verificata in base a dimensioni e spessori della lastra. / The feasibility of making certain decorations may depend on plate size and thickness.
 Tutte le parti di questo catalogo - foto comprese - sono di proprietà Euro-Fer. La riproduzione, anche parziale, è vietata in ogni forma e con ogni mezzo. / Every part of this catalogue - photos included - is Euro-Fer's property. All forms of copying are strictly prohibited.

Richiedere scheda informativa all'ufficio tecnico.
Please contact the technical office for more information.



NEW



98

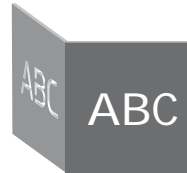

PIASTRE PER PIANTONI ferro grezzo / BASE PLATES raw iron

SPESSORE / THICKNESS mm 4 - 6

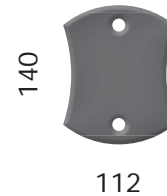
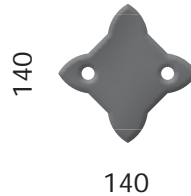
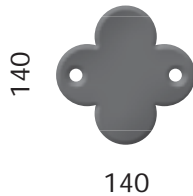
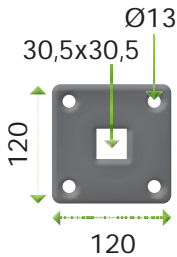

LP001.40/10.FE
LP001.60/10.FE

LP002.40/10.FE
LP002.60/10.FE

LP003.40/10.FE
LP003.60/10.FE

LP004.40/10.FE
LP004.60/10.FE

LP005.40/10.FE
LP005.60/10.FE

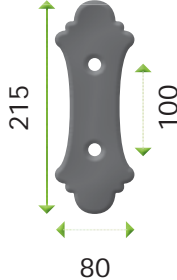
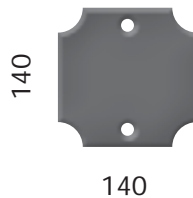
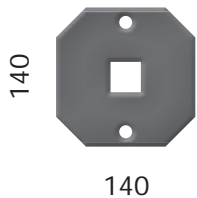

LP006.40/10.FE
LP006.60/10.FE

LP007.40/10.FE
LP007.60/10.FE

LP008.40/10.FE
LP008.60/10.FE

STAFFE DI FISSAGGIO ferro grezzo / LUGS & FIXINGS raw iron

SPESSORE / THICKNESS mm 4 - 6

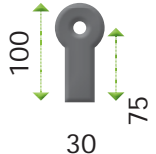
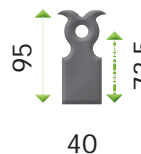
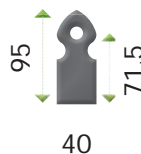
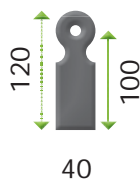

LS001.40/10.FE
LS001.60/10.FE

LS002.40/10.FE
LS002.60/10.FE

LS003.40/10.FE
LS003.60/10.FE

LS004.40/10.FE
LS004.60/10.FE

LS005.40/10.FE
LS005.60/10.FE

LS006.40/10.FE
LS006.60/10.FE

La fattibilità della realizzazione del decoro va verificata in base a dimensioni e spessori della lastra. / The feasibility of making certain decorations may depend on plate size and thickness.

Tutte le parti di questo catalogo - foto comprese - sono di proprietà Euro-Fer. La riproduzione, anche parziale, è vietata in ogni forma e con ogni mezzo. / Every part of this catalogue - photos included - is Euro-Fer's property. All forms of copying are strictly prohibited.

SPESSORE / THICKNESS mm 4 - 6



1000x120 mm
LG001.40/10.FE
LG001.60/10.FE



1000x100 mm
LG005.40/10.FE
LG005.60/10.FE



1200x120 mm
LG008.40/10.FE
LG008.60/10.FE

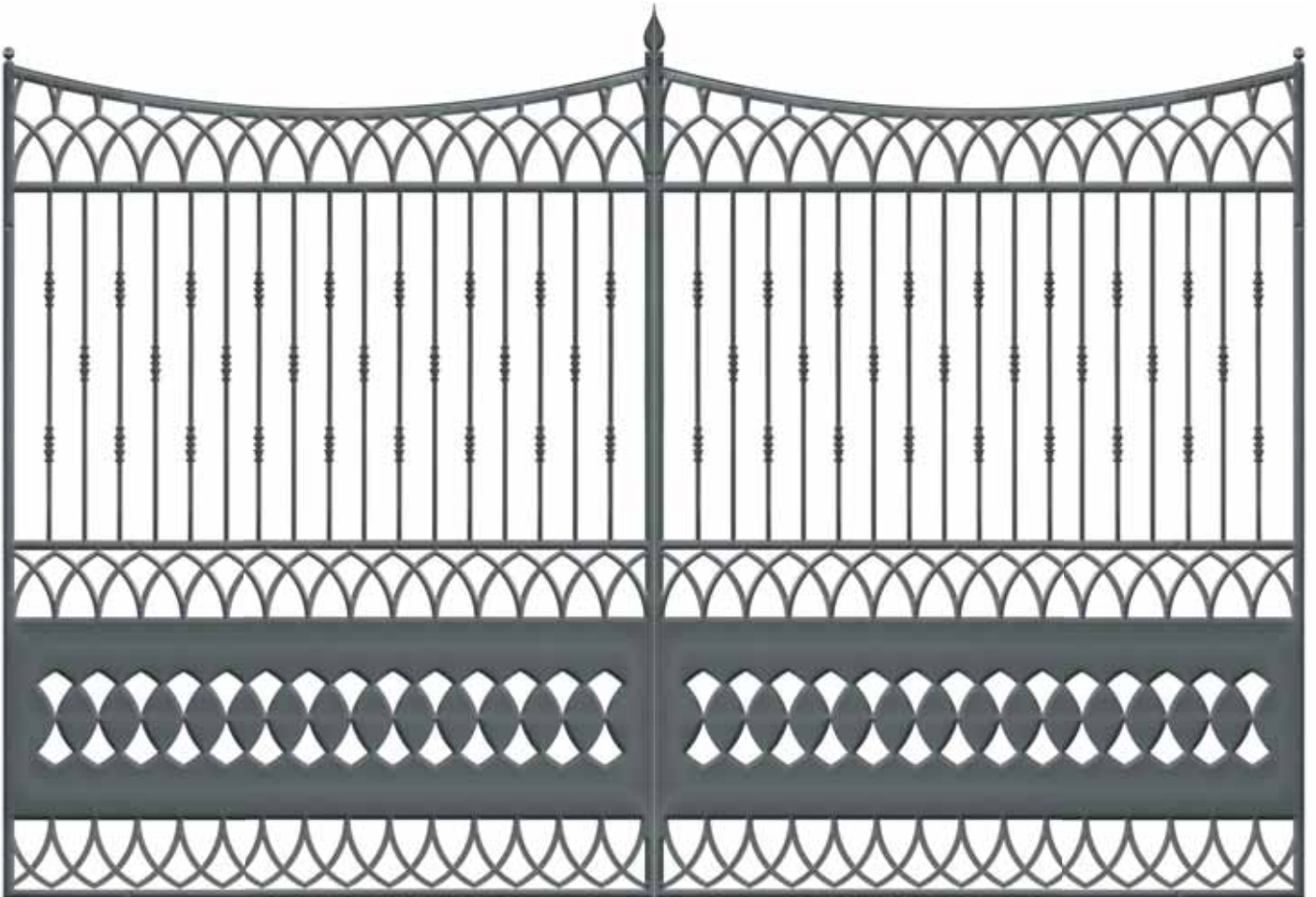

esempio / example

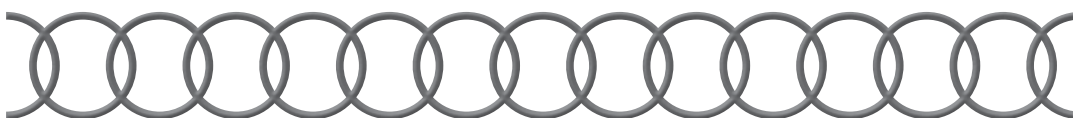

1200x120 mm
LG009.40/10.FE
LG009.60/10.FE



1200x100 mm
LG014.40/10.FE
LG014.60/10.FE

La fattibilità della realizzazione del decoro va verificata in base a dimensioni e spessori della lastra. / The feasibility of making certain decorations may depend on plate size and thickness.
Tutte le parti di questo catalogo - foto comprese - sono di proprietà Euro-Fer. La riproduzione, anche parziale, è vietata in ogni forma e con ogni mezzo. / Every part of this catalogue - photos included - is Euro-Fer's property. All forms of copying are strictly prohibited.

SPESSORE / THICKNESS mm 4 - 6

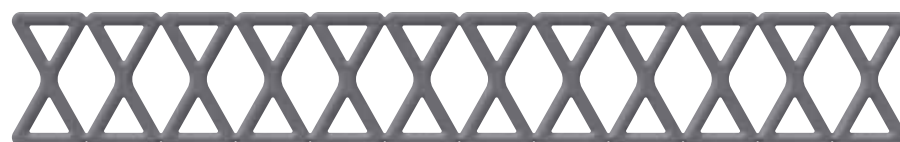
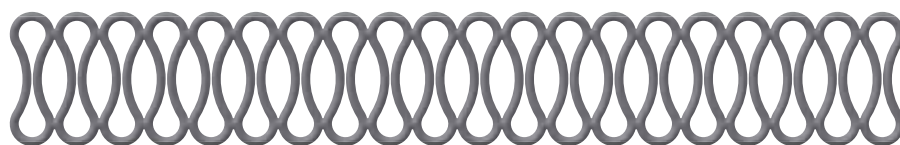
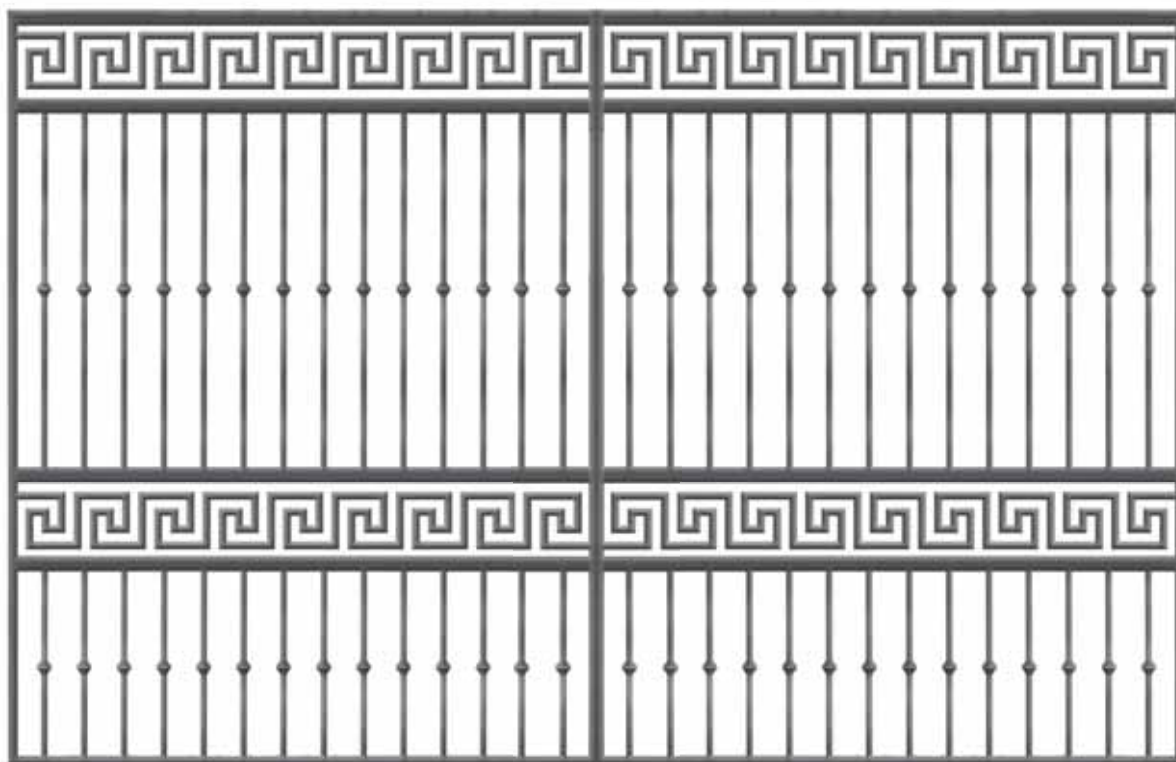

La fattibilità della realizzazione del decoro va verificata in base a dimensioni e spessori della lastra. / The feasibility of making certain decorations may depend on plate size and thickness.

Tutte le parti di questo catalogo - foto comprese - sono di proprietà Euro-Fer. La riproduzione, anche parziale, è vietata in ogni forma e con ogni mezzo. / Every part of this catalogue - photos included - is Euro-Fer's property. All forms of copying are strictly prohibited.

NEW

CIMASE per cancelli / ORNAMENTS for carriage gates

NEW

L

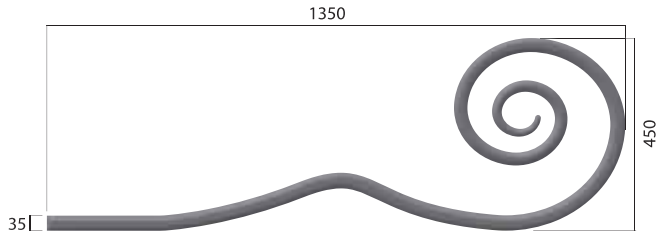

Vendute in coppia
Sold in pairs 2 p.

LC001.40/10.FE
LC001.60/10.FE

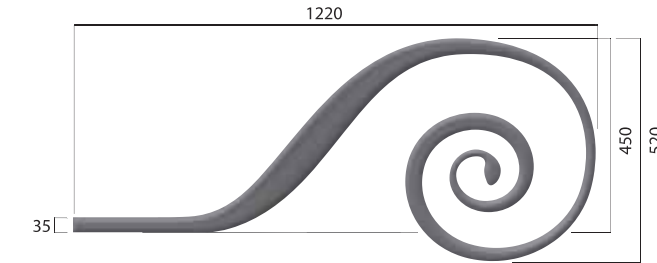

Vendute in coppia
Sold in pairs 2 p.

LC002.40/10.FE
LC002.60/10.FE

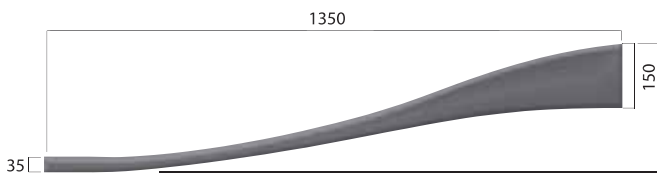

Vendute in coppia
Sold in pairs 2 p.

LC003.40/10.FE
LC003.60/10.FE



Vendute in coppia
Sold in pairs 2 p.

LC004.40/10.FE
LC004.60/10.FE

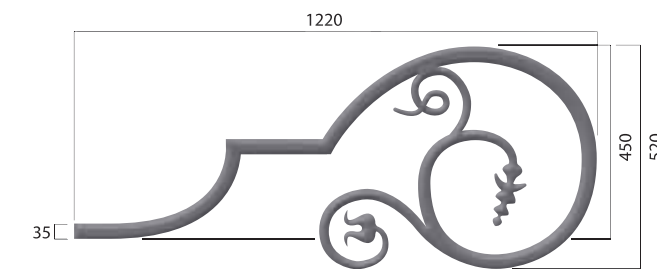

Vendute in coppia
Sold in pairs 2 p.

LC005.40/10.FE
LC005.60/10.FE



Vendute singolarmente
Sold individually 1 p.

LC006.40/10.FE
LC006.60/10.FE

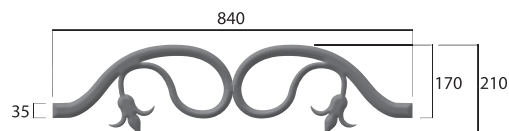

Vendute singolarmente
Sold individually 1 p.

LC007.40/10.FE
LC007.60/10.FE

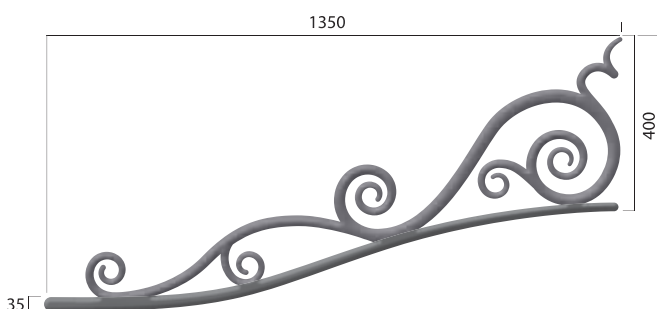

Vendute in coppia
Sold in pairs 2 p.

LC008.40/10.FE
LC008.60/10.FE

La fattibilità della realizzazione del decoro va verificata in base a dimensioni e spessori della lastra. / The feasibility of making certain decorations may depend on plate size and thickness.
Tutte le parti di questo catalogo - foto comprese - sono di proprietà Euro-Fer. La riproduzione, anche parziale, è vietata in ogni forma e con ogni mezzo. / Every part of this catalogue - photos included - is Euro-Fer's property. All forms of copying are strictly prohibited.

from art. LC001.40/10.FE to art. LC008.60/10.FE

EUROFER

305

Le linee Eurofer / Eurofer lines



FERRO BATTUTO / WROUGHT IRON

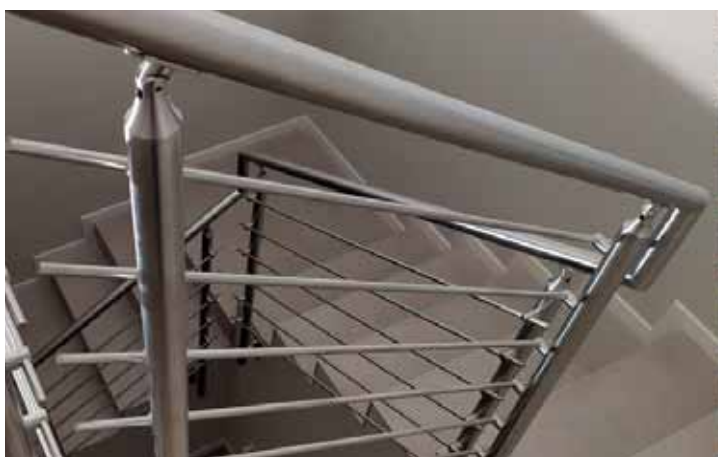

ACCIAIO INOX / STAINLESS STEEL



LASERFER



RECINZIONI / MODULAR FENCES



CANCELLI / GATES



GRADIUS ALUMINIUM

PALIXON



BAND|BOO®



ROSE COLLECTION CRYSTALS FROM SWAROVSKI®





Tutte le parti di questo catalogo –foto, disegni, testi e grafica- sono di proprietà Euro-Fer®. La loro riproduzione, pubblicazione, trasmissione, duplicazione e comunicazione anche solo parziale sono vietate in ogni forma e con ogni mezzo salvo espressa autorizzazione di Euro-Fer® spa.

Dati, foto e caratteristiche tecniche non sono impegnativi. Euro-Fer® si riserva il diritto di apportare modifiche che riterrà opportune per migliorare i suoi prodotti.

Euro-Fer® è un marchio registrato. Tutti i diritti riservati.

All the parts of this catalogue –photos, drawings, designs and texts- are Euro-Fer® spa property. Their partial or total publication, trasmission, copy, communication or other duplication are forbidden without special consent by Euro-Fer® spa.

Data, photos and technical characteristics are not binding. Euro-Fer® reserves the right to change the content of this catalogue without notice.

Euro-Fer® is a registered trademark. All rights reserved.



Euro-Fer è un'azienda amica dell'ambiente e alimenta gran parte del ciclo produttivo con energia solare.

Euro-Fer is an environmentally-friendly company that uses solar energy in most of its production cycle.



EUROFER®

LAVORAZIONE DEL FERRO BATTUTO & ACCIAIO INOX
WROUGHT IRON & STAINLESS STEEL WORKING

EURO-FER S.p.A.

Viale dell'Industria, 16/18
Castelgomberto (Vicenza) Italy

tel +39 0445 440033
fax +39 0445 440351
e-mail eurofer@eurofer.com

 EuroFer S.P.A.
 euroferspa
 Euro-Fer
Euro-Fer Rose

www.eurofer.com



www.rosecollection.it



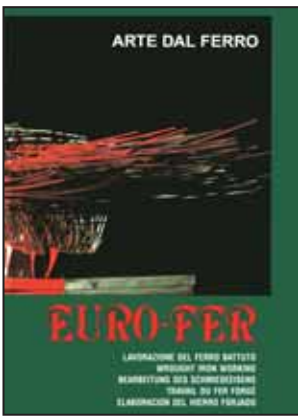

Art. 1000
Arte dal ferro / Art of wrought iron
 1300 articoli / articles
 2700 variazioni di sezioni e di altezze /
different sections and heights
 50 disegni di composizioni dimostrative
/ design of possible creationsm

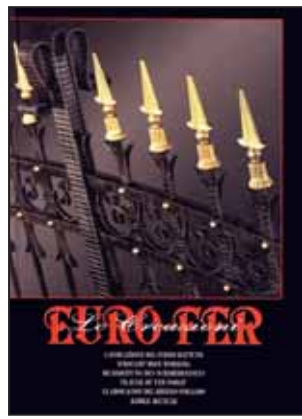

Art. 2000
Le creazioni Euro-Fer
Euro-Fer creations
 circa 1000 articoli / articles
 2400 variazioni di sezioni e di altezze /
different sections and heights
 oltre 100 foto di realizzazioni / *more than*
 100 foto of creations

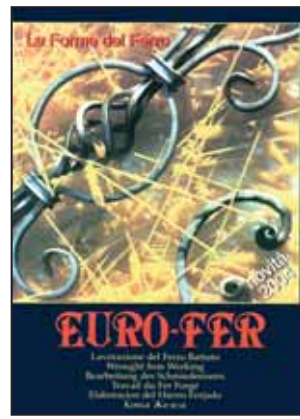

Art. 4000
Le forme del ferro
The shapes of iron



Art. 4100
Tra ferro e fuoco
Between iron and fire



Art. 5000
Quaderni 01 2005



Art. 5001
Quaderni 02 2005



Art. 5002
Le foto



Art. 10000
Powder coated products



Art. 00EZ
EZ Inox
 Ez-inox: l'inox facile
Ez-inox: easy inox



Art. 9000
Cancelli Linear e Gradius
 Moduli zincati pronti per
 l'installazione *Galvanized modules*
 ready to use



Art. 11000
Rose Collection
 Collezione Rose realizzata in ferro battuto
 o in acciaio inox con inserti di cristallo,
 utilizzo per interni. / *Indoor collection*
 Rose, an innovative combination between
 ornamental wrought iron, or stainless
 steel products, made with crystal inserts.

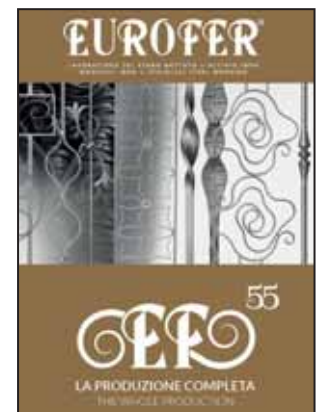

Art. 7003
La produzione completa
The whole production



COLLAGE.01
 Collage 1.0 è un'applicazione nata per
 la creazione di composizioni grafiche
 e la generazione della distinta relativa
 agli articoli Euro-Fer scelti dall'archivio
 fornito. / *Collage 1.0 is an application*
 created to produce graphic compositions
 using Euro-Fer's products.

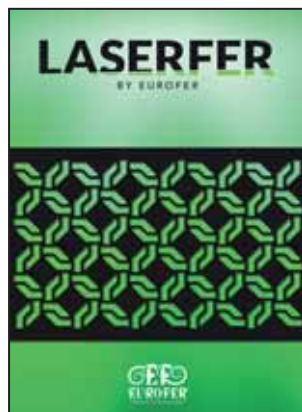

Art. 8000
Laserfer

NEW

LASERFFER
BY EUROFER

Contiene la gamma rinnovata della linea Laserfer.
Includes the updated range of the Laserfer line.

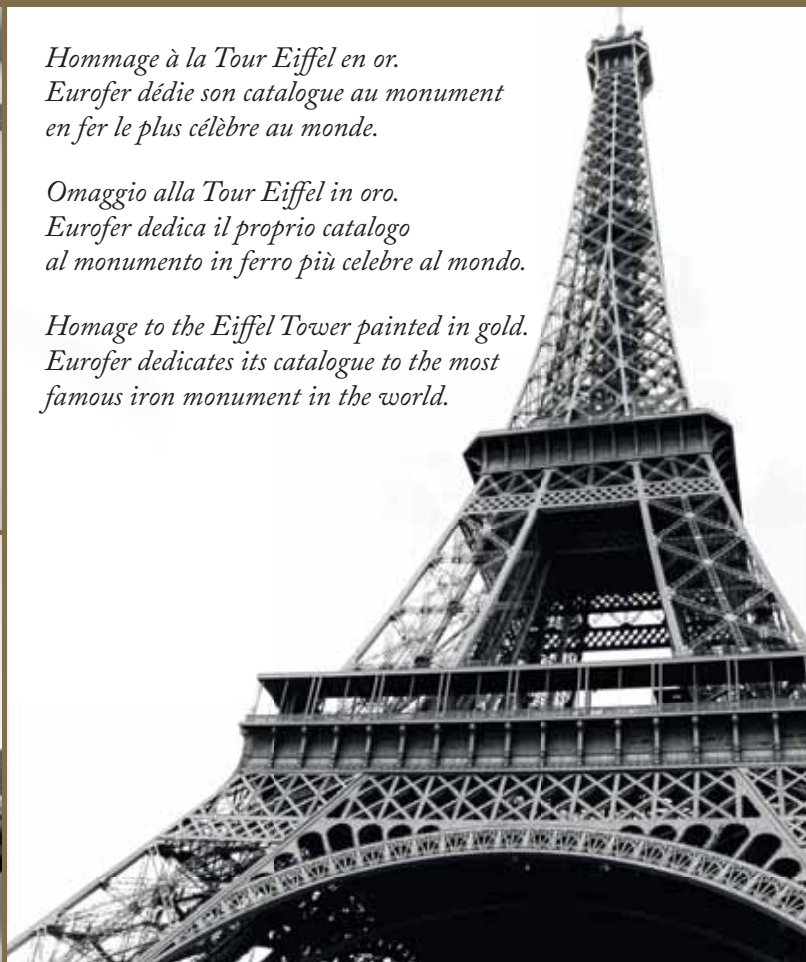

*Hommage à la Tour Eiffel en or.
Eurofer dédie son catalogue au monument
en fer le plus célèbre au monde.*

*Omaggio alla Tour Eiffel in oro.
Eurofer dedica il proprio catalogo
al monumento in ferro più celebre al mondo.*

*Homage to the Eiffel Tower painted in gold.
Eurofer dedicates its catalogue to the most
famous iron monument in the world.*

EURO-FER S.p.A.

Viale dell'Industria 16/18
Castelgomberto (Vicenza)
Telefono: +39 0445 440033
FAX: +39 0445 440351
E-mail: eurofer@eurofer.com

www.eurofer.com

